

● 特点

1. 电流转换比 CTR: 50~600% (在  $I_F=5mA$ ,  $V_{CE}=5V$  条件下)
2. 输入、输出端之间绝缘电压高 ( $V_{ISO}=3750V_{rms}$ )
3. 采用 4 引脚微型 SOP 封装结构,
4. 环保符合 RoHS 要求
5. 安规符合 CQC、UL、VDE、CE 要求

● 说明

1. JC357 是一种光耦合隔离器件, 它由一个红外二极管和一个 NPN 光敏管组成
2. JC357 的 PIN 间距为 2.54mm

● 应用

1. 各类通讯设备.
2. 系统装置, 测量仪器.
3. 高低电压电路间的电气隔离和信号传输.

● 外形尺寸

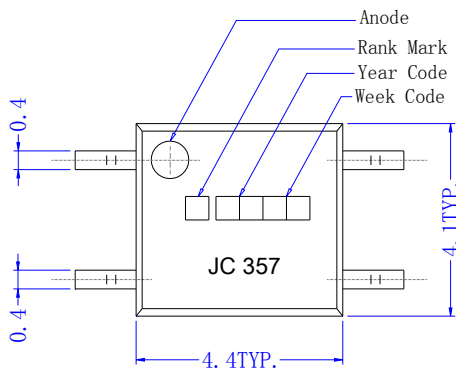

PIN NO. AND INTERNAL CONNECTION DIAGRAM

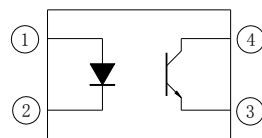

- |           |             |
|-----------|-------------|
| 1 Anode   | 3 Emitter   |
| 2 Cathode | 4 Collector |

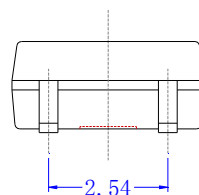
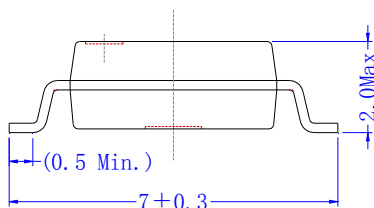

●光电特性 (Ta=25°C)

参数		符号	测试条件	最小值	典型值	最大值	单位
输入端	顺向电压	$V_F$	$I_F=20\text{mA}$	---	1.2	1.4	V
	逆向电流	$I_R$	$V_R=4\text{V}$	---	---	10	$\mu\text{A}$
	终端电容	$C_t$	$V=0, f=1\text{KHz}$	---	30	250	pF
输出端	集电极暗电流	$I_{CEO}$	$V_{CE}=20\text{V}, I_F=0$	---	---	100	nA
	集电极-发射极崩溃电压	$BV_{CEO}$	$I_C=0.1\text{mA}$ $I_F=0$	80	---	---	V
	发射极-集电极崩溃电压	$BV_{ECO}$	$I_E=10\mu\text{A}$ $I_F=0$	7	---	---	V
	集电极电流	$I_c$	$I_F=5\text{mA}$	4	---	30	mA
	*2 电流转换比	CTR	$V_{CE}=5\text{V}$	80	---	600	%
	饱和电压	$V_{CE(sat)}$	$I_F=20\text{mA}$ $I_C=1\text{mA}$	---	0.1	0.2	V
	绝缘电阻	$R_{iso}$	DC500V 40~60%R.H.	$5 \times 10^{10}$	---	---	$\Omega$
	电容	$C_f$	$V=0, f=1\text{MHz}$	---	0.6	1	pF
	截止频率	$f_c$	$V_{CE}=5\text{V}, I_C=2\text{mA}$ $R_L=100\Omega, -3\text{dB}$	---	80	---	kHz
	反应时间 (上升)	$t_r$	$V_{CE}=2\text{V}, I_C=2\text{mA}$	---	4	18	$\mu\text{s}$
	反应时间 (下降)	$t_f$	$R_L=100\Omega$	---	3	18	$\mu\text{s}$

\*1:  $CTR = I_c / I_F \times 100\%$

●CTR 的分档

BIN 级	最小值 (%)	最大值 (%)
A	80	160
B	130	260
C	200	400
D	300	600
A or B or C or D	80	600

以上测试条件是:  $I_F=5\text{mA}, V_{CE}=5\text{V}, T_a=25^\circ\text{C}$ .

● 极限参数 (Ta=25°C)

参数		符号	额定值	单位
输入端	顺向电流	$I_F$	50	mA
	逆向电压	$V_R$	6	V
	耗散功率	$P_D$	70	mW
输出端	集电极-发射极崩溃电压	$V_{CEO}$	80	V
	发射极-集电极崩溃电压	$V_{ECO}$	7	
	集电极电流	$I_C$	50	mA
	集电极耗散功率	$P_C$	150	mW
总耗散功率		$P_{tot}$	200	mW
*1 绝缘电压		$V_{iso}$	3750	Vrms
工作温度		$T_{opr}$	-55 to + 110	°C
存储温度		$T_{stg}$	-55 to + 125	
*2 焊接温度		$T_{sol}$	260	

\*1. 交流 1 分钟, 湿度为 40~60%

使用如下方式测试高压:

- (1) 输入端的正极和负极短接、输出端的集电极和发射极短接;
- (2) 所使用交流电电压须为正弦波。

\*2. 焊接时间在 10 秒内。

● 特性曲线

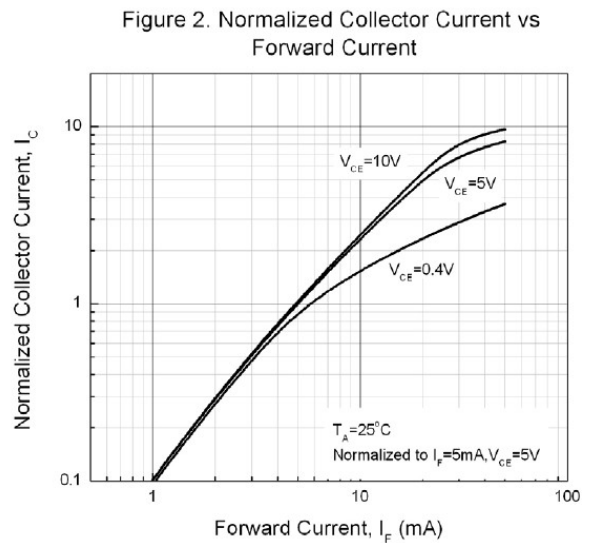
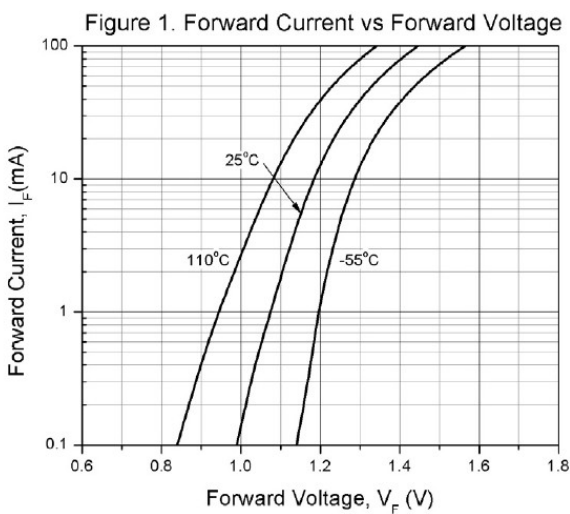

● 特性曲线

Figure 3. Normalized Current Transfer Ratio vs Forward Current

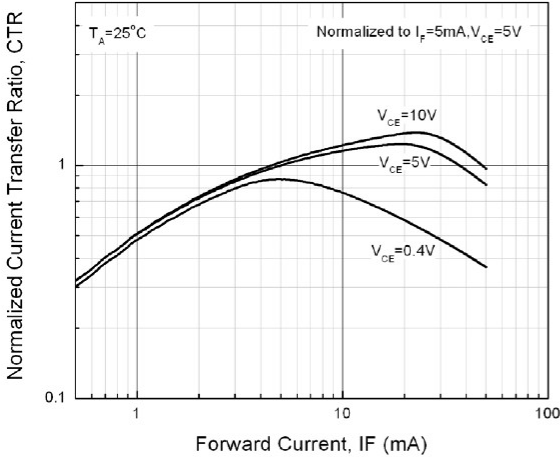

Figure 4. Normalized Collector Current vs Ambient Temperature

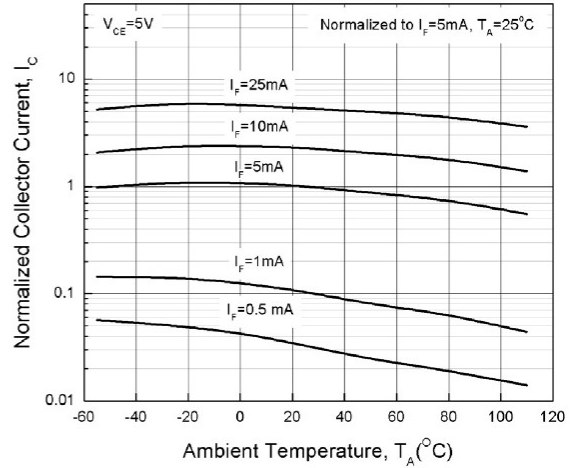

Figure 5. Collector Current vs Collector-Emitter Voltage

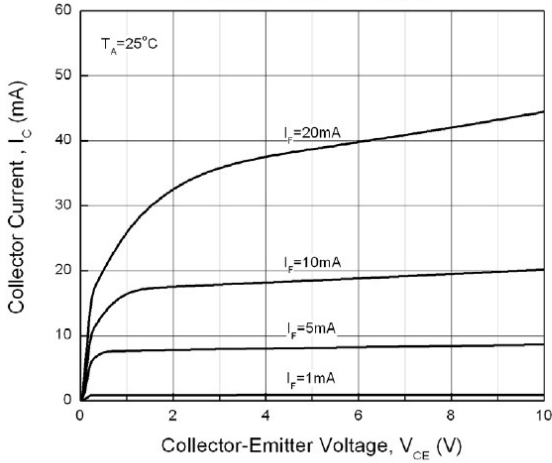

Figure 6. Collector Current vs Collector-Emitter Voltage

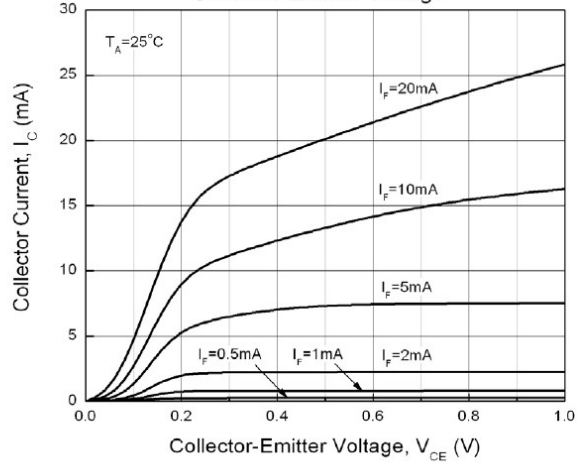

Figure 7. Collector Dark Current vs Ambient Temperature

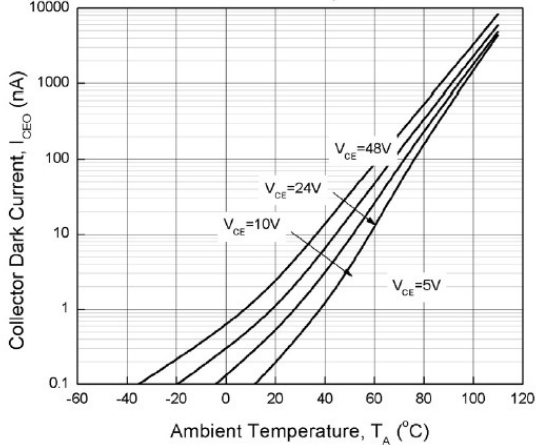
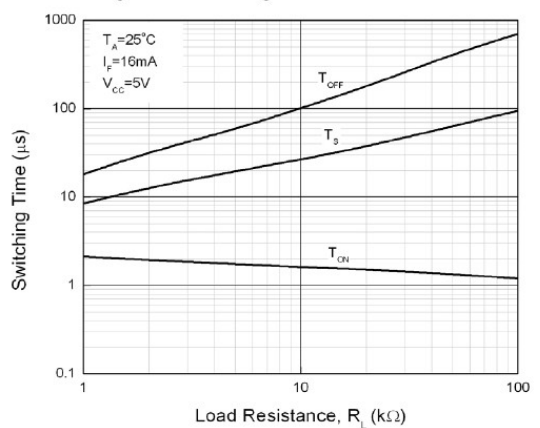
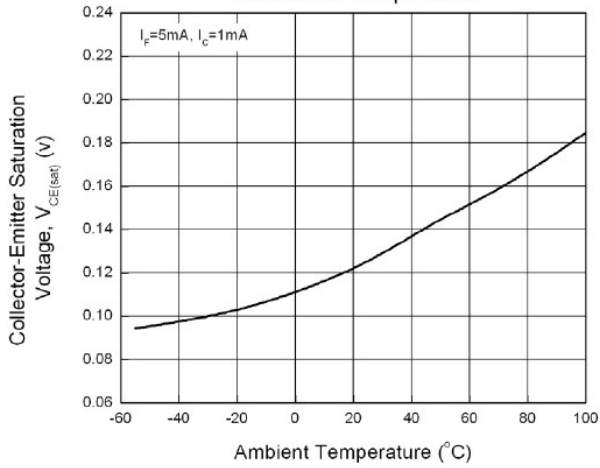

Figure 8. Switching Time vs Load Resistance



● 特性曲线

Figure 9. Collector-Emitter Saturation Voltage vs Ambient Temperature



Test Circuit for Response Time

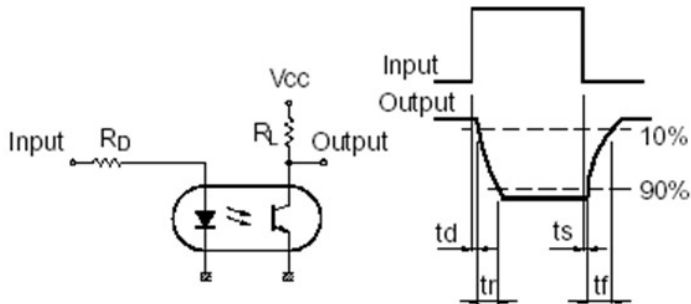

Test Circuit for Frequency Response

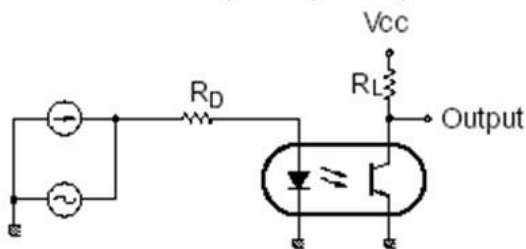

● 安装位置尺寸推荐:

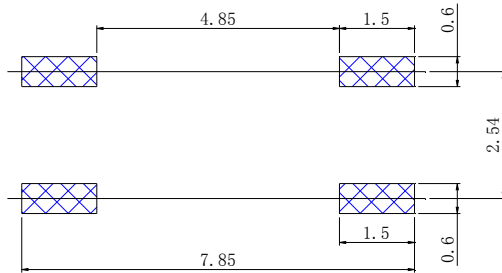

● 包装

A、载带尺寸:

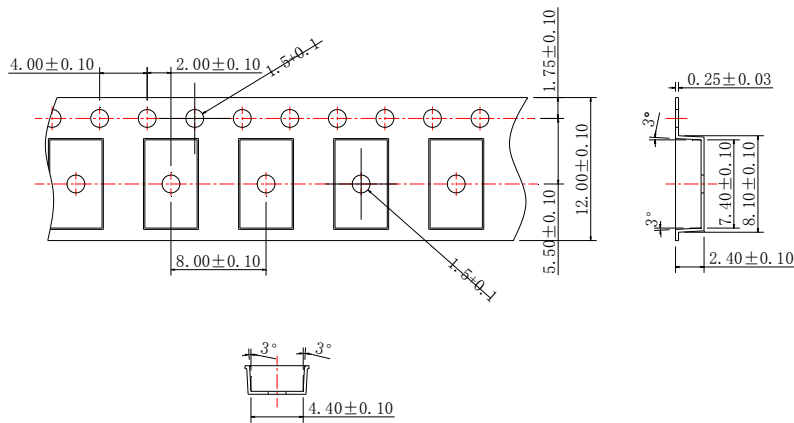

B、装带方向:

