

Surface Mount Schottky Barrier Rectifier

Reverse Voltage - 30 to 90

Forward Current - 1.0 A

FEATURES

- Metal silicon junction, majority carrier conduction
- For surface mounted applications
- Low power loss, high efficiency
- High forward surge current capability
- For use in low voltage, high frequency inverters, free wheeling, and polarity protection applications



PIN DESCRIPTION 1: Cathode 2: Anode

Simplified outline SOD-123FL and symbol

MECHANICAL DATA

- Case: SOD-123FL
- Terminals: Solderable per MIL-STD-750, Method 2026
- Approx. Weight: 15mg 0.00048oz

Absolute Maximum Ratings and Electrical characteristics

Ratings at 25°C ambient temperature unless otherwise specified. Single phase, half wave, 60Hz resistive or inductive load, for capacitive load, derate by 20 %

Parameter	Symbols	RB160M-30	RB160M-40	RB160M-60	RB160M-90	Units
Maximum Repetitive Peak Reverse Voltage	V_{RRM}	30	40	60	90	V
Maximum RMS voltage	V_{RMS}	21	28	42	63	V
Maximum DC Blocking Voltage	V_{DC}	30	40	60	90	V
Maximum Average Forward Rectified Current	$I_{F(AV)}$	1.0				A
Peak Forward Surge Current, 8.3ms Single Half Sine-wave Superimposed on Rated Load (JEDEC method)	I_{FSM}	40			30	A
Max Instantaneous Forward Voltage at 1 A	V_F	0.55		0.70	0.85	V
Maximum DC Reverse Current $T_a = 25^\circ\text{C}$ at Rated DC Reverse Voltage $T_a = 100^\circ\text{C}$	I_R	0.3 10			0.2 5	mA
Typical Junction Capacitance ¹⁾	C_j	110	80			pF
Typical Thermal Resistance ²⁾	$R_{\theta JA}$	115				°C/W
Operating Junction Temperature Range	T_j	-55 ~ +125				°C
Storage Temperature Range	T_{stg}	-55 ~ +150				°C

1) Measured at 1MHz and applied reverse voltage of 4 V D.C. 2) P.C.B. mounted with 0.2 X 0.2" (5 X 5 mm) copper pad areas.

Fig.1 Forward Current Derating Curve

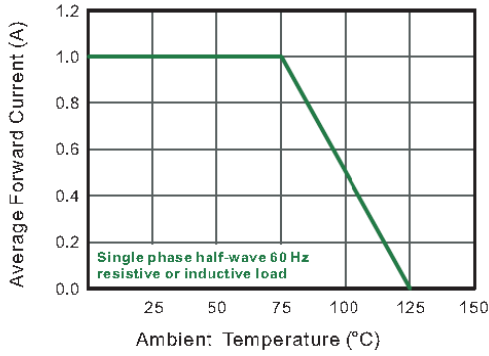

Fig.2 Typical Reverse Characteristics

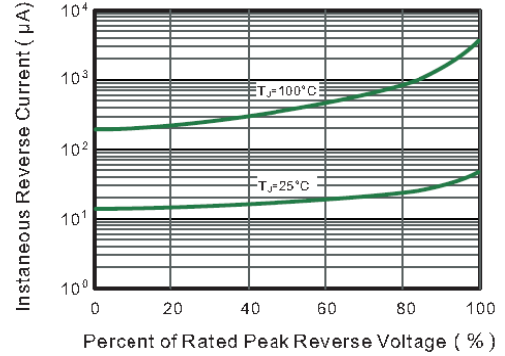

Fig.3 Typical Forward Characteristic

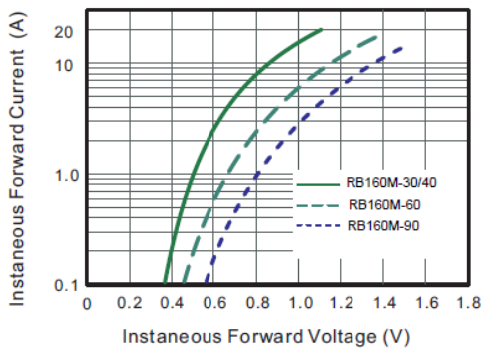

Fig.4 Typical Junction Capacitance

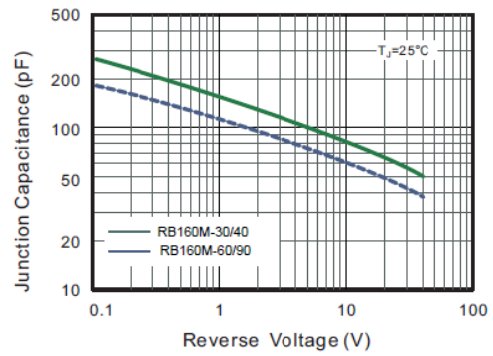

Fig.5 Maximum Non-Repetitive Peak Forward Surge Current

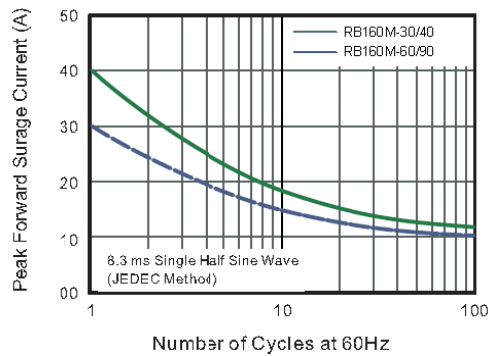
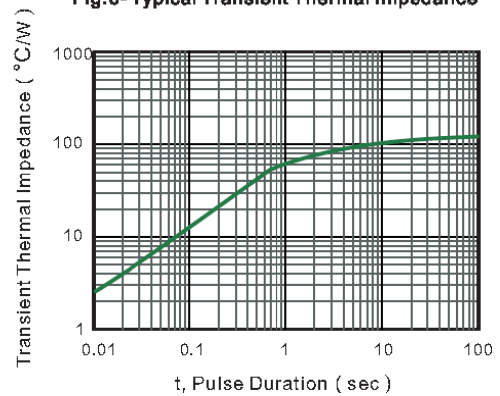

Fig.6 Typical Transient Thermal Impedance



PACKAGE OUTLINE

Plastic surface mounted package; 2 leads

SOD-123FL

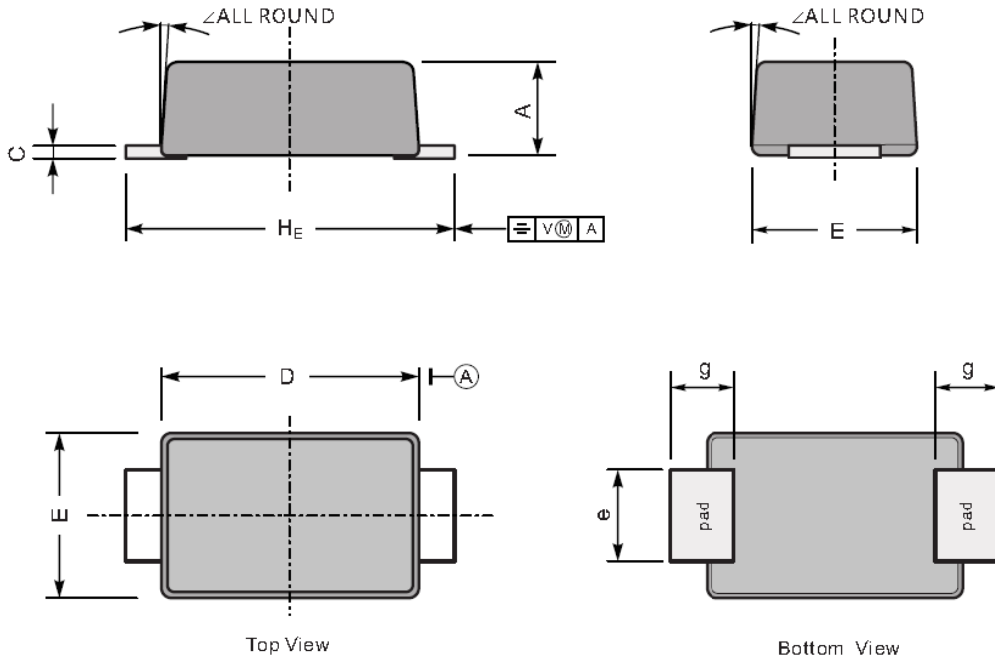

UNIT		A	C	D	E	e	g	HE	∠
mm	max	1.1	0.20	2.9	1.9	1.1	0.9	3.8	7°
	min	0.9	0.12	2.6	1.7	0.8	0.7	3.5	
mil	max	43	7.9	114	75	43	35	150	
	min	35	4.7	102	67	31	28	138	

The recommended mounting pad size

