

## 1.5KE SERIES

### TRANSIENT VOLTAGE SUPPRESSOR DIODES

#### FEATURE

- . UL Recognized File # E-96005
- . Plastic package has Underwriters Laboratory Flammability Classification 94V-0
- . 1500W surge capability at 10×100us waveform, Duty cycle: 0.01%
- . Excellent clamping capability
- . Low zener impedance
- . Fast response time: Typically less than 1.0ps from 0 volts to VBR for unidirectional and 5.0ns for bidirectional
- . Typical IR less than 1 μA above 10V
- . High temperature soldering guaranteed: 260°C/10 seconds / .375" lead length / 5lbs tension

#### MECHANICAL DATA

- . Terminal: Plated axial leads solderable per MIL-STD 202E, method 208C
- . Case: Molded with UL-94 Class V-0 recognized Flame Retardant Epoxy
- . Polarity: color band denotes cathode except bipolar

Voltage Range  
6.8 to 400 Vots  
1500 Watts Peak Power  
5.0Watt Steady State

#### DO-27/DO-201AD

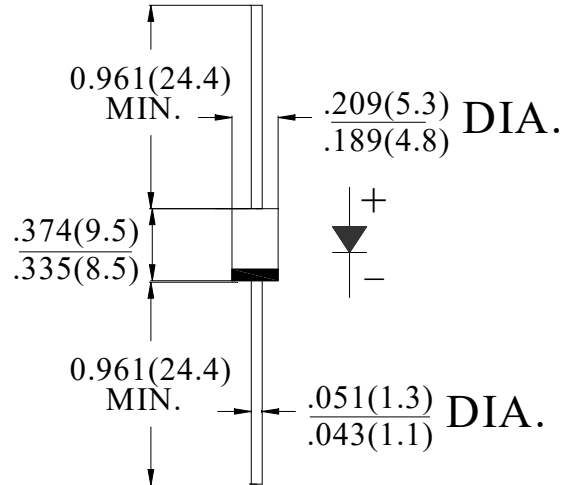

Dimensions in inches and (millimeters)

### MAXIMUM RATINGS AND ELECTRICAL CHARACTERISTICS

Rating at 25°C ambient temperature unless otherwise stated.

Single-phase, half-wave, 60HZ, resistive or inductive load. For capacitive load, derate current by 20%

Type Number	SYM BOL	Value	units
Peak Power Dissipation at Ta=25°C, Tp=1ms (note 1)	$P_{PPM}$	Minimum 1500	Watts
Steady State Power Dissipation .375" lead length at TL=75°C (note 2)	$P_D$	5.0	Watts
Peak Forward Surge Current 8.3ms Single Half Sine-wave Superimposed on Rated Load (JEDEC method) (note 3)	$I_{FSM}$	200	Amps
Storage Temperature	$T_{STG}$	-55 to +150	°C
Operating Junction Temperature	$T_J$	-55 to +150	°C

#### Note:

1. Non-repetitive Current Pulse Per Fig.3 and Derated above Ta=25°C Per Fig.2 .
2. Mounted on Copper Pad Area of 1.6×1.6" (40×40mm) Per Fig.5 .
3. 8.3ms Single Half Sine-wave or Equivalent Square Wave, Duty Cycle=4 Pulses Per Minutes Maximum.

#### Devices for Bipolar Applications

1. For Bidirectional Use C or CA Suffix for Types 1.5KE6.8 thru Types 1.5KE400.
2. Electrical Characteristics Apply in Both Directions.

**ELECTRICAL CHARACTERISTICS**(TA=25°C unless otherwise noted)

Device		Nominal Voltage (volts)	Breakdown Voltage VBR (volts)(note1)		Test Current @IT (mA)	Stand-Off Voltage VWM (volts)	Maximum Reverse Leakage At VWM ID(μA)	Maximum Peak Pulse Current IPPM (note2)(Amps)	Maximum Clamping Voltage at IPPM VC(Volts)	Maximum Temperature Coefficient Of VBR(%/°C)
			Min	Max						
UNI	BI									
1.5KE6.8	1.5KE6.8C	6.8	6.12	7.48	10	5.50	1000	145	10.8	0.057
1.5KE6.8A	1.5KE6.8CA	6.8	6.45	7.14	10	5.80	1000	150	10.5	0.057
1.5KE7.5	1.5KE7.5C	7.5	6.75	8.25	10	6.05	500	134	11.7	0.061
1.5KE7.5A	1.5KE7.5CA	7.5	7.13	7.88	10	6.40	500	139	11.3	0.061
1.5KE8.2	1.5KE8.2C	8.2	7.38	9.02	10	6.63	200	126	12.5	0.065
1.5KE8.2A	1.5KE8.2CA	8.2	7.79	8.61	10	7.02	200	130	12.1	0.065
1.5KE9.1	1.5KE9.1C	9.1	8.19	10.0	1.0	7.37	50	114	13.8	0.068
1.5KE9.1A	1.5KE9.1CA	9.1	8.65	9.55	1.0	7.78	50	117	13.4	0.068
1.5KE10	1.5KE10C	10	9.00	11.0	1.0	8.10	10	105	15.0	0.073
1.5KE10A	1.5KE10CA	10	9.50	10.5	1.0	8.55	10	108	14.5	0.073
1.5KE11	1.5KE11C	11	9.90	12.1	1.0	8.92	5.0	97	16.2	0.075
1.5KE11A	1.5KE11CA	11	10.5	11.6	1.0	9.40	5.0	100	15.6	0.075
1.5KE12	1.5KE12C	12	10.8	13.2	1.0	9.72	5.0	91	17.3	0.078
1.5KE12A	1.5KE12CA	12	11.4	12.6	1.0	10.2	5.0	94	16.7	0.078
1.5KE13	1.5KE13C	13	11.7	14.3	1.0	10.5	5.0	82	19.0	0.081
1.5KE13A	1.5KE13CA	13	12.4	13.7	1.0	11.1	5.0	86	18.2	0.081
1.5KE15	1.5KE15C	15	13.5	16.5	1.0	12.1	5.0	71	22.0	0.084
1.5KE15A	1.5KE15CA	15	14.3	15.8	1.0	12.8	5.0	74	21.2	0.084
1.5KE16	1.5KE16C	16	14.4	17.6	1.0	12.9	5.0	67	23.5	0.086
1.5KE16A	1.5KE16CA	16	15.2	16.8	1.0	13.6	5.0	70	22.5	0.086
1.5KE18	1.5KE18C	18	16.2	19.8	1.0	14.5	5.0	59	26.5	0.088
1.5KE18A	1.5KE18CA	18	17.1	18.9	1.0	15.3	5.0	60	25.2	0.088
1.5KE20	1.5KE20C	20	18.0	22.0	1.0	16.2	5.0	54	29.1	0.090
1.5KE20A	1.5KE20CA	20	19.0	21.0	1.0	17.1	5.0	56	27.7	0.090
1.5KE22	1.5KE22C	22	19.8	24.2	1.0	17.8	5.0	49	31.9	0.092
1.5KE22A	1.5KE22CA	22	20.9	23.1	1.0	18.8	5.0	51	30.6	0.092
1.5KE24	1.5KE24C	24	21.6	26.4	1.0	19.4	5.0	45	34.7	0.094
1.5KE24A	1.5KE24CA	24	22.8	25.2	1.0	20.5	5.0	47	33.2	0.094
1.5KE27	1.5KE27C	27	24.3	29.7	1.0	21.8	5.0	40	39.1	0.096
1.5KE27A	1.5KE27CA	27	25.7	28.4	1.0	23.1	5.0	42	37.5	0.096
1.5KE30	1.5KE30C	30	27.0	33.0	1.0	24.3	5.0	36	43.5	0.097
1.5KE30A	1.5KE30CA	30	28.5	31.5	1.0	25.6	5.0	38	41.4	0.097
1.5KE33	1.5KE33C	33	29.7	36.3	1.0	26.8	5.0	33	47.7	0.098
1.5KE33A	1.5KE33CA	33	31.4	34.7	1.0	28.2	5.0	34	45.7	0.098
1.5KE36	1.5KE36C	36	32.4	39.6	1.0	29.1	5.0	30	52	0.099
1.5KE36A	1.5KE36CA	36	34.2	37.8	1.0	30.8	5.0	31	49.9	0.099
1.5KE39	1.5KE39C	39	35.1	42.9	1.0	31.6	5.0	27	56.4	0.100
1.5KE39A	1.5KE39CA	39	37.1	41.0	1.0	33.3	5.0	29	53.9	0.100
1.5KE43	1.5KE43C	43	38.7	47.3	1.0	34.8	5.0	25	61.9	0.101
1.5KE43A	1.5KE43CA	43	40.9	45.2	1.0	36.8	5.0	26	59.3	0.101
1.5KE47	1.5KE47C	47	42.3	51.7	1.0	38.1	5.0	23	67.8	0.101
1.5KE47A	1.5KE47CA	47	44.7	49.4	1.0	40.2	5.0	24	64.8	0.101
1.5KE51	1.5KE51C	51	45.9	56.1	1.0	41.3	5.0	21	73.5	0.102
1.5KE51A	1.5KE51CA	51	48.5	53.6	1.0	43.6	5.0	22	70.1	0.102
1.5KE56	1.5KE56C	56	50.4	61.6	1.0	45.4	5.0	19	80.5	0.103
1.5KE56A	1.5KE56CA	56	53.2	58.8	1.0	47.8	5.0	20	77	0.103
1.5KE62	1.5KE62C	62	55.8	68.2	1.0	50.2	5.0	17	89	0.104

1.5KE62A	1.5KE62CA	62	58.9	65.1	1.0	53.0	5.0	18	85	0.104
1.5KE68	1.5KE68C	68	61.2	74.8	1.0	55.1	5.0	16	98	0.104
1.5KE68A	1.5KE68CA	68	64.6	71.4	1.0	58.1	5.0	17	92	0.104
1.5KE75	1.5KE75C	75	67.5	82.5	1.0	60.7	5.0	14	108	0.105
1.5KE75A	1.5KE75CA	75	71.3	78.8	1.0	64.1	5.0	15	103	0.105
1.5KE82	1.5KE82C	82	73.8	90.2	1.0	66.4	5.0	13	118	0.105
1.5KE82A	1.5KE82CA	82	77.9	86.1	1.0	70.1	5.0	13.9	113	0.105
1.5KE91	1.5KE91C	91	81.9	100.0	1.0	73.7	5.0	12	131	0.106
1.5KE91A	1.5KE91CA	91	86.5	95.5	1.0	77.8	5.0	12.6	125	0.106
1.5KE100	1.5KE100C	100	90.0	110.0	1.0	81.0	5.0	10.9	144	0.106
1.5KE100A	1.5KE100CA	100	95.0	105.0	1.0	85.5	5.0	11.4	137	0.106
1.5KE110	1.5KE110C	110	99	121	1.0	89.2	5.0	9.9	158	0.107
1.5KE110A	1.5KE110CA	110	105.0	116.0	1.0	94.0	5.0	10.3	152	0.107
1.5KE120	1.5KE120C	120	108.0	132.0	1.0	97.2	5.0	9.1	173	0.107
1.5KE120A	1.5KE120CA	120	114.0	126.0	1.0	102.0	5.0	9.5	165	0.107
1.5KE130	1.5KE130C	130	117.0	143.0	1.0	105.0	5.0	8.4	187	0.107
1.5KE130A	1.5KE130CA	130	124.0	137.0	1.0	111.0	5.0	8.7	179	0.107
1.5KE150	1.5KE150C	150	135.0	165.0	1.0	121.0	5.0	7.3	215	0.108
1.5KE150A	1.5KE150CA	150	143.0	158.0	1.0	128.0	5.0	7.6	207	0.108
1.5KE160	1.5KE160C	160	144.0	176.0	1.0	130.0	5.0	6.8	230	0.108
1.5KE160A	1.5KE160CA	160	152.0	168.0	1.0	136.0	5.0	7.1	219	0.108
1.5KE170	1.5KE170C	170	153.0	187.0	1.0	138.0	5.0	6.4	244	0.108
1.5KE170A	1.5KE170CA	170	162.0	179.0	1.0	145.0	5.0	6.7	234	0.108
1.5KE180	1.5KE180C	180	162.0	198.0	1.0	146.0	5.0	6.1	258	0.108
1.5KE180A	1.5KE180CA	180	171.0	189.0	1.0	154.0	5.0	6.4	246	0.108
1.5KE200	1.5KE200C	200	180.0	220.0	1.0	162.0	5.0	5.4	287	0.108
1.5KE200A	1.5KE200CA	200	190.0	210.0	1.0	171.0	5.0	5.7	274	0.108
1.5KE220	1.5KE220C	220	198.0	242.0	1.0	175.0	5.0	4.5	344	0.108
1.5KE220A	1.5KE220CA	220	209.0	231.0	1.0	185.0	5.0	4.8	328	0.108
1.5KE250	1.5KE250C	250	225.0	275.0	1.0	202.0	5.0	4.3	360	0.110
1.5KE250A	1.5KE250CA	250	237.0	263.0	1.0	214.0	5.0	4.5	344	0.110
1.5KE300	1.5KE300C	300	270.0	330.0	1.0	243.0	5.0	3.6	430	0.110
1.5KE300A	1.5KE300CA	300	285.0	315.0	1.0	256.0	5.0	3.8	414	0.110
1.5KE350	1.5KE350C	350	315.0	385.0	1.0	284.0	5.0	3.1	504	0.110
1.5KE350A	1.5KE350CA	350	332.0	368.0	1.0	300.0	5.0	3.2	482	0.110
1.5KE400	1.5KE400C	400	360.0	440.0	1.0	324.0	5.0	2.7	574	0.110
1.5KE400A	1.5KE400CA	400	380.0	420.0	1.0	342.0	5.0	2.8	548	0.110

**Note:**

1. VBR measured after IT applied for 300us, IT=square wave pulse or equivalent.
2. Surge current waveform per Figure 3 and derate per Figure 2.
3. For bipolar types having VWM of 10 volts and under, the ID limit is doubled.
4. All terms and symbols are consistent with ANSI/IEEE C62.35.

RATING AND CHARACTERISTIC CURVES

FIG.1-PEAK PULSE POWER RATING CURVE

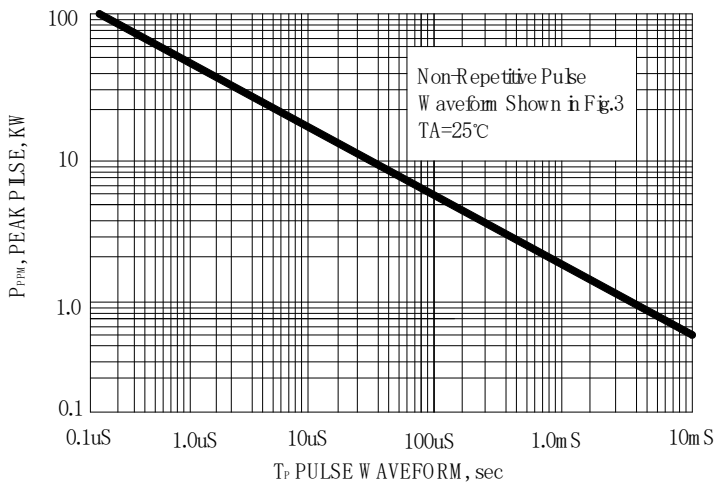

FIG.2-PULSE DERATING CURVE

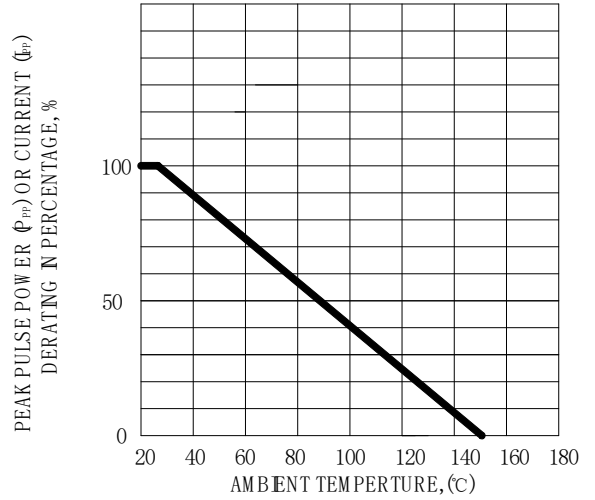

FIG.3-PULSE WAVEFORM

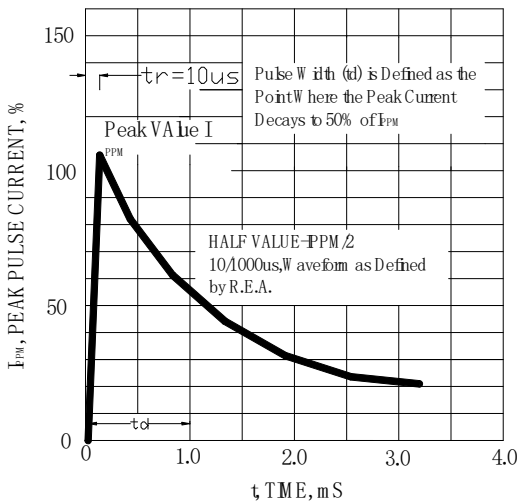

FIG.4-TYPICAL JUNCTION CAPACITANCE

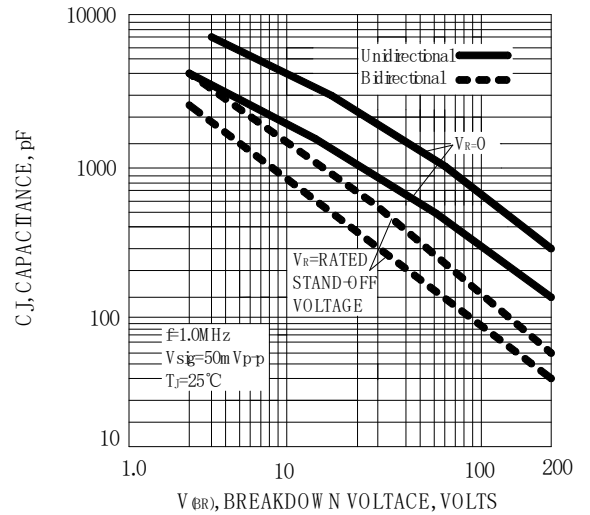

FIG.5-STeady State Power Derating Curve

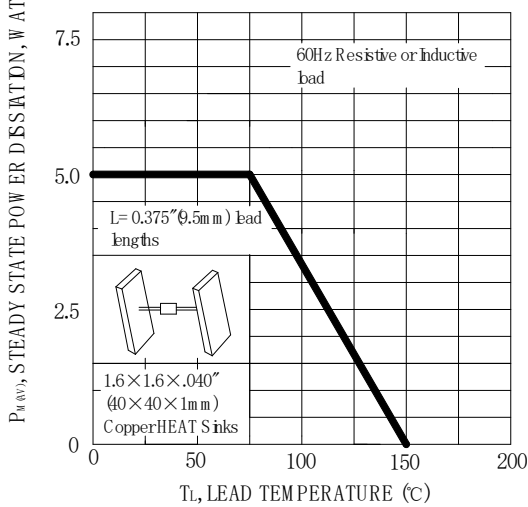
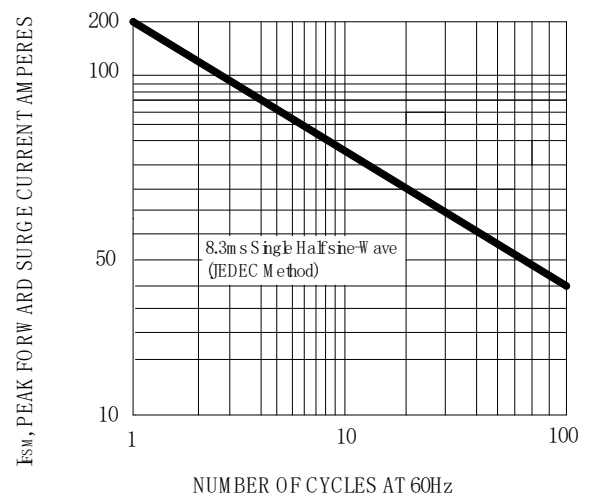
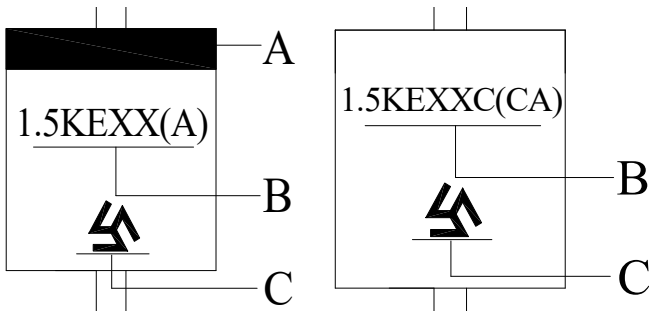

FIG.6-MAXIMUM NON-REPETITIVE FORWARD SURGE CURRENT UNIDIRECTIONAL



## Marking and packaging illustration

### 1、Marking



SYMBOL	Explanation
A	Color Band Denotes Cathode
B	Product Name
C	Trademark

### 2、Packaging

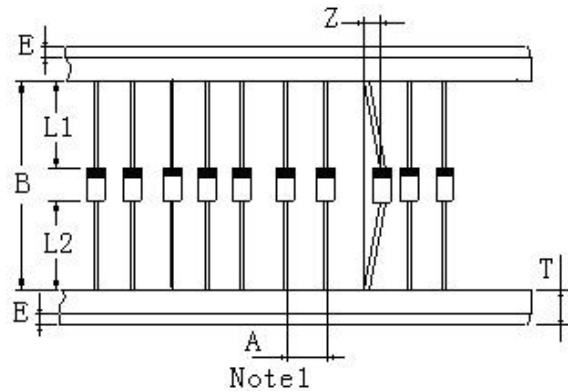

Note1

ITEM	SYMBOL	SPECIFICATIONS (mm)	SPECIFICATIONS (inch)
Component alignment	Z	1.2max	0.048max
Tape width	T	6.0±0.4	0.236±0.016
Exposed adhesive	E	0.8max	0.032max
Body eccentricity	L1-L2	1.0max	0.040max
Component	A	10.0±0.5	0.4±0.02
Inner tap	B	52.0~53.5	2.05~2.11

NOTE:

Each component lead shall be sandwiched between tapes for a minimum of 2.5mm (0.1inch)