

	Chip Trimmer Capacitor	Document No	Rev. No	Page	Rev. Date
		STC3M-SP-14	4	13	13-Jun-19

PRODUCT SPECIFICATIONS

Model: STC3M Series (ver 4.0)

Cumtomer : _____

SEHWA Electronics Co., Ltd

Approved	Checked	Prepared

	Chip Trimmer Capacitor	Document No	Rev. No	Page	Rev. Date
		STC3M-SP-14	4	13	13-Jun-19

-CONTENTS-

- 1. SCOPE**
- 2. PART NUMBERING & APPLICATION**
- 3. DIMENSIONS, PCB LAND PATTERNS & PACKING METHOD**
- 4. CHARACTERISTICS**
 - 4.1. Electrical Specifications Table
 - 4.2. Mechanical Specifications Table
 - 4.3. Environmental Specifications Table
- 5. TEST CONDITION**
 - 5.1 Normal Test Condition
 - 5.2 Standard Test Condition
- 6. TEST METHOD**
 - 6.1. Capacitance
 - 6.2. Capacitance Drift
 - 6.3. "Q" Factor
 - 6.4. Insulation Resistance
 - 6.5. Rated Voltage
 - 6.6. Rotation Torque
 - 6.7. Rotation Life
 - 6.8. Temperature coefficient
 - 6.9. Vibration Test
 - 6.10. Free Drop
 - 6.11. Solderability
 - 6.12. High Temperature Test
 - 6.13. Resistance to soldering heat
 - 6.14. Humidity Heat Test
 - 6.15. Low Temperature Test
 - 6.16. Cleaning Test
 - 6.17. Submersion Test
- 7. PACKING AND REEL DIMENSION**
- 8. CAUTIONS**

	Chip Trimmer Capacitor	Document No	Rev. No	Page	Rev. Date
		STC3M-SP-14	4	13	13-Jun-19

4. CHARACTERISTICS

4.1 Electrical Specifications Table

[TABLE-1]

Item	STC3MA03 3pf	STC3MA06 6pf	STC3MB10 10pf	STC3MD20 20pf	STC3ME30 30pf	REMARK
	Black	Blue	Ivory	Pink	Green	
Capacitance (pF Min)	1.5 max	2.0 max	3.0 max	5.5 max	8.0 max	
Capacitance (pF Max)	3.0 ⁺⁵⁰ ₋₀ %	6.0 ⁺⁵⁰ ₋₀ %	10.0 ⁺⁵⁰ ₋₀ %	20.0 ⁺⁵⁰ ₋₀ %	30.0 ⁺⁵⁰ ₋₀ %	
Capacitance Drift (Max)	± 2%	± 2%	± 2%	± 3%	± 3%	
Temperature Coefficient (ppm / °C)	NP0±300	NP0±200	N600±400	N900±400	N1200±300	
Q value (at 1 MHz, C max)	300 Min	500 Min	600 Min	500 Min	250 Min	
Insulation Resistance	10 ⁴ MΩMin	10 ⁴ MΩMin	10 ⁴ MΩMin	10 ⁴ MΩMin	10 ⁴ MΩMin	
DC Rated Voltage	100 VDC	100 VDC	100 VDC	100 VDC	100 VDC	
DC Withstanding Voltage	220 VDC	220 VDC	220 VDC	220 VDC	220 VDC	
Rotation Torque	15 ~ 72 gf.cm					
Solderability	More than 75% of soldering wetting area shall be continuously wet with solder					

4.2 Mechanical Specifications Table

[TABLE-2]

Item	STC3MA03 3pf	STC3MA06 6pf	STC3MB10 10pf	STC3MD20 20pf	STC3ME30 30pf	REMARK
	Capacitance Change Ratio					
Resistance to Soldering heat TEST METHOD 6-13	±3%	±3%	±4%	± 5%	± 6%	
Vibration TEST METHOD 6-9	±2%	±2%	±2%	± 3%	± 5%	
Free Drop TEST METHOD 6-10	± 2%	± 2%	± 2%	± 3%	± 5%	
Rotation Life TEST METHOD 6-7	±3%	±3%	±4%	±6%	±10%	
Operating Temperature	- 25°C to 85°C					

Item	Resistance to Soldering heat T/S METHOD 6-13	Vibration T/S METHOD 6-9	Free Drop T/S METHOD 6-10	Rotation Life T/S METHOD 6-7
Rotation Torque	15 gf.cm (Min)	15 ~ 72 gf.cm	15 ~ 72 gf.cm	15 ~ 72 gf.cm

4.3 Environmental Specifications Table

[TABLE-3]

High TempTest (Test Method 6-12)						
Item	3pf	6pf	10pf	20pf	30pf	REMARK
Cap' Change (%)	± 2%	± 2%	±3%	± 3%	± 5%	
Min Q Value	400 Min	400 Min	500 Min	500 Min	300 Min	
Insulation resistance	10 ⁴ Min	10 ⁴ Min	10 ⁴ Min	10 ⁴ Min	10 ⁴ Min	

Humidity Test (Test Method 6-14)						
Item	3pf	6pf	10pf	20pf	30pf	REMARK
Cap' Change (%)	±2%	±2%	±3%	±5%	±5%	
Min Q Value	300 Min	300 Min	500 Min	400 Min	200 Min	
Insulation resistance	10 ⁴ Min	10 ⁴ Min	10 ⁴ Min	10 ⁴ Min	10 ⁴ Min	

Low Temp Test (Test Method 6-15)						
Item	3pf	6pf	10pf	20pf	30pf	REMARK
Cap' Change (%)	± 2%	± 2%	±3%	± 3%	± 5%	
Min Q Value	300 Min	300 Min	500 Min	400 Min	250 Min	
Insulation resistance	10 ⁴ Min	10 ⁴ Min	10 ⁴ Min	10 ⁴ Min	10 ⁴ Min	

Cleaning Test (Test Method 6-16)						
Item	3pf	6pf	10pf	20pf	30pf	REMARK
Cap' Change (%)	± 2%	± 2%	±3%	± 3%	± 5%	
Min Q Value	400 Min	500 Min	500 Min	400 Min	250 Min	
Insulation resistance	10 ⁴ Min	10 ⁴ Min	10 ⁴ Min	10 ⁴ Min	10 ⁴ Min	

Submersion Test (Test Method 6-17)						
Item	3pf	6pf	10pf	20pf	30pf	REMARK
Cap' Change (%)	± 2%	± 2%	± 2%	± 3%	± 5%	
Min Q Value	400 Min	400 Min	500 Min	400 Min	200 Min	
Insulation resistance	10 ⁴ Min	10 ⁴ Min	10 ⁴ Min	10 ⁴ Min	10 ⁴ Min	

	Chip Trimmer Capacitor	Document No	Rev. No	Page	Rev. Date
		STC3M-SP-14	4	13	13-Jun-19

5. TEST CONDITION

5.1 Normal Test Condition

Unless otherwise specified, test and measurement shall be performed under the standard condition:

- Ordinary temperature : 15 ~ 30 °C
- Humidity : Relative humidity 45 ~ 85 %

5.2 Standard Test Condition

If there is any doubts arise about the results, measurements shall be made under the following condition:

- Ordinary temperature : 20 ± 2 °C
- Humidity : Relative humidity 65 ± 5 %

6. TEST METHOD

6.1. Capacitance

When measured at a frequency of 1.0±0.2MHz, Minimum capacitance shall not be greater than that of specified, and Maximum capacitance shall not be less than the specified maximum capacitance.

6.2. Capacitance Drift

The capacitor shall be measured at the maximum capacitance position with test frequency of 1.0±0.2MHz. (Rotate the rotor at the speed of 10r/min. by one direction.)

After then set the initial value in 5 seconds and leave it for 120±20 minutes.

6.3. "Q" Factor

The capacitor shall be measured at the maximum capacitance position with test frequency of 1.0±0.2MHz. (Measurement voltage is 1V±0.1Vrms)

6.4. Insulation Resistance

Insulation resistance shall be measured at the Maximum capacitance position with 300V voltage.

The charge time is 60±5sec.

6.5. Rated Voltage

The capacitor shall be measured at the maximum capacitance position.

Measurement voltage is DC 150V for 1 hours.

No short, damage or deterioration shall be found after finishing the test.

6.6. Rotation Torque

The rotor shall be turned 360° clockwise and counter-clockwise before measurement.

Rotate the rotor at the speed "10 round/min", clockwise and counter-clockwise while the test the torque shall be measured.

6.7. Rotation Life

The capacitor shall be measured at the maximum capacitance position.

Rotate the rotor 180° clockwise and turn it back. And then rotate the rotor 180° counter clockwise and turn it back to original position. This is one cycle.

After repeating 60cycle, measure the capacitance. (Rotation speed is "10 round/min")

6.8. Temperature coefficient

Capacitance adjust measurement at 80 ~ 90 percent of maximum rated capacitance shall be made at the temperatures specified in the [Table-1] and the capacitance shall be made after the capacitor has reached thermal stability.

[Table-1]

Step	1	2	3	4	5
Sequence	20±2°C	-25±2°C	20±2°C	85±3°C	20±2°C

The temperature coefficient shall be calculated in accordance with the following formula

$$TC = \frac{(C2 - C1) \cdot 10^6}{(T2 - T1) \cdot C1}$$

TC : Temperature coefficient(ppm/°C) in temperature T2

C1 : Initial capacitance value(pF) at step 3.

C2 : Capacitance(pF) at specified temperature.

T1 : 20°C (step 3)

T2 : Test temperature (step 3 or 4)

Capacitance-change shall be within the limits that of specified in [Table-1] & [figure-1]

*** Temperature characteristics**

***STC3MA03- 3pf CURVE**

[Figure-1]

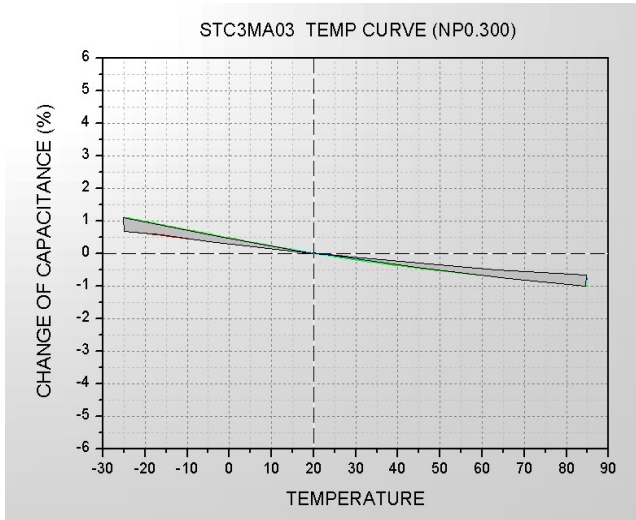

***STC3MA06- 6pf CURVE**

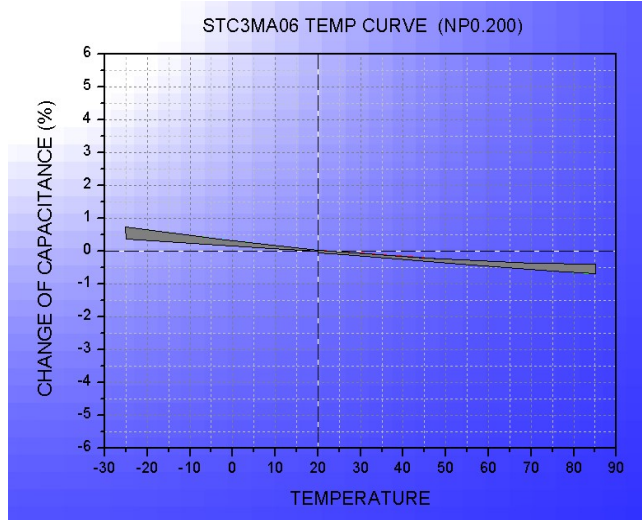

***STC3MB10- 10pf CURVE**

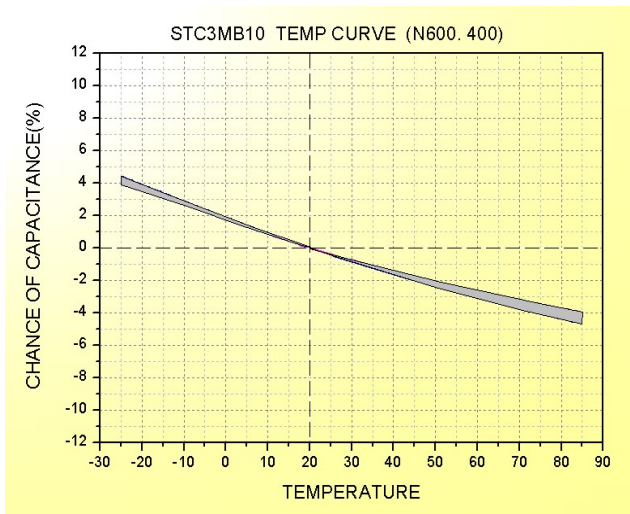

***STC3MD20- 20pf CURVE**

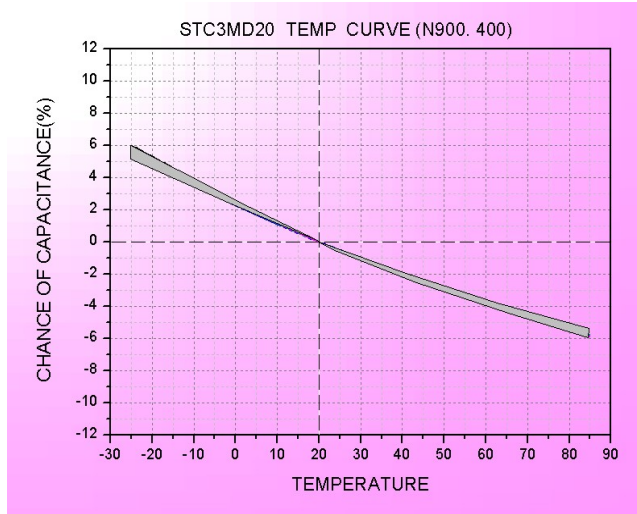

***STC3ME30- 30pf CURVE**

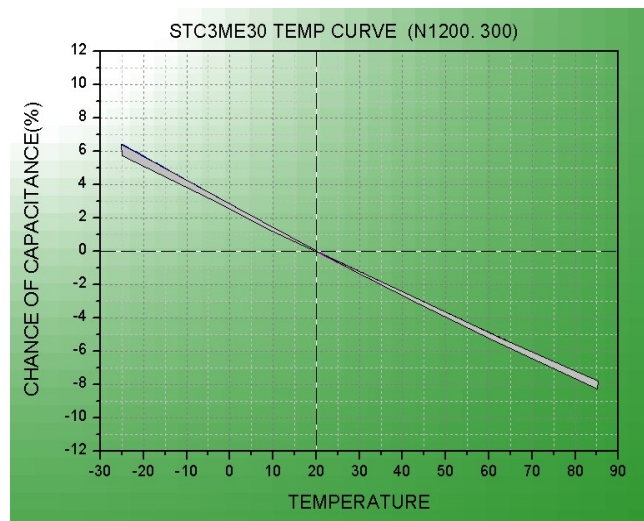

***STC3M Series Capacitance vs Frequency Curve**

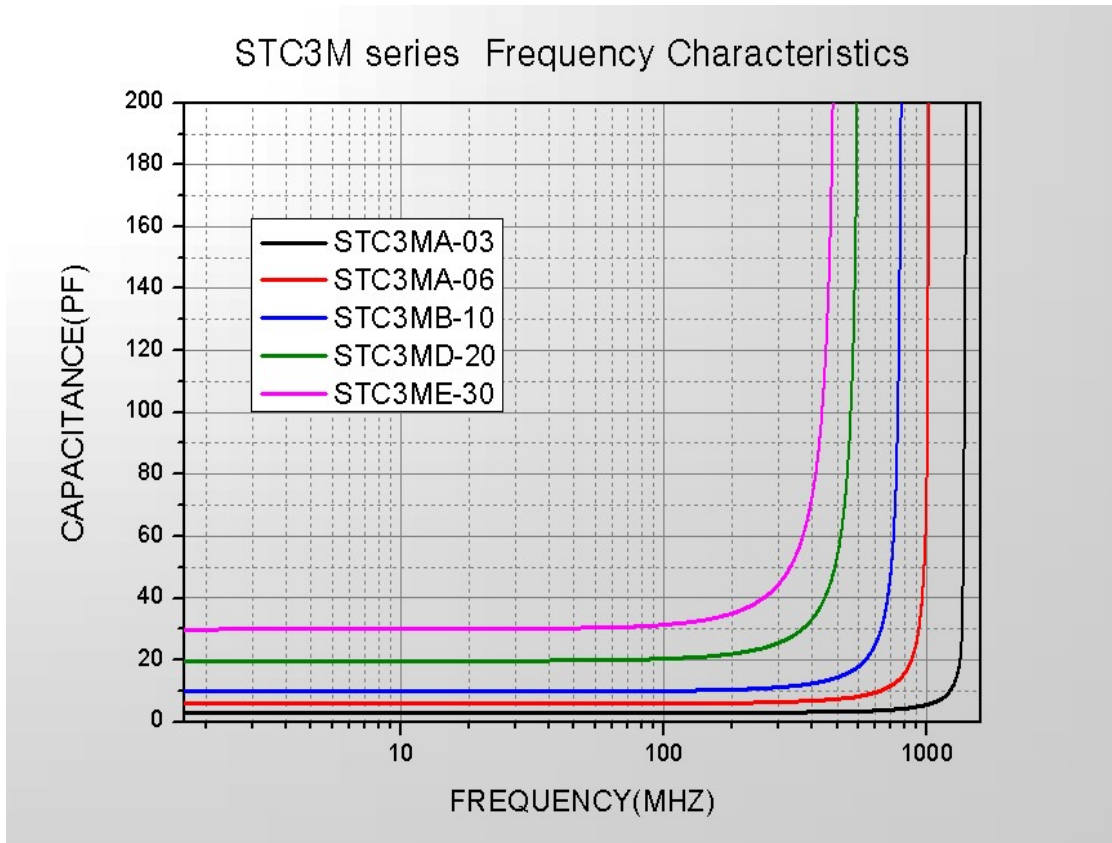

***STC3M Series Self-Resonant Frequency Curve**

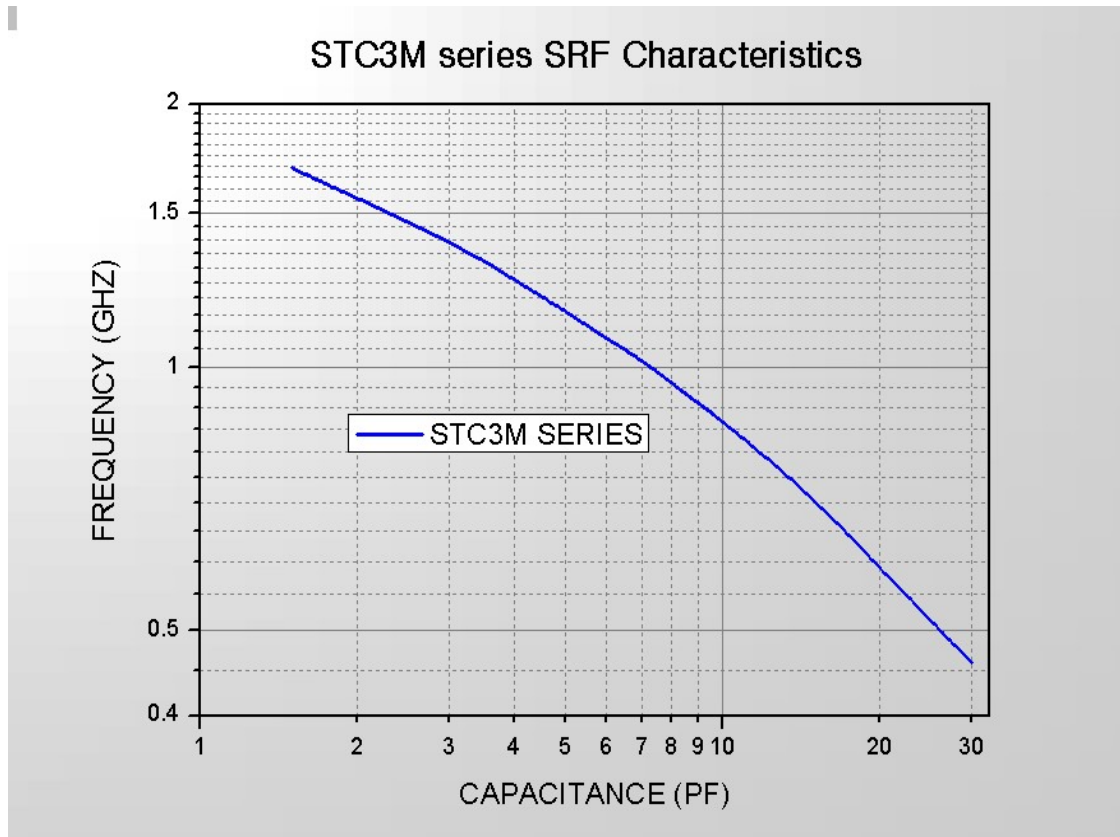

6.9. Vibration Test

The capacitor shall be measured at the maximum capacitance position.

The capacitor shall be kept under the condition of the full amplitude of 1.8mm for 2hours. (120 cycles)

Test is performed under Traverse method: 1cycle = 1 minute, 10Hz(Start) ~ 50Hz ~ 10Hz(End)

6.10. Free Drop

The capacitor shall be measured at the maximum capacitance position.

The samples shall be attached on 50g jig. And then drop it onto wood board from 1.2m height 3 times in each mutually perpendicular direction. Total 6 times.

6.11. Solderability

Dip the terminal in the solder bath set at the solder temperature $230 \pm 5^{\circ}\text{C}$ for $3 \pm 1\text{sec}$.

The terminal shall be dipped more than 75% of portion.

Solder: 3C05, 5A35 (sn-ag)

6.12. High Temperature Test

The capacitor shall be measured at the maximum capacitance position.

The chamber temperature shall be kept $85 \pm 3^{\circ}\text{C}$. Keep the sample capacitor in the chamber for 48 ± 2 hours.

After then, keep the sample capacitor in normal condition for 2hours before measure it.

6.13. Resistance to soldering heat

The capacitor shall be measured at the maximum capacitance position. Do the reflow of [Figure-2].

After then, keep the capacitor in "NORMAL TEST CONDITION" for 2hours before measure it.

[Figure-2]

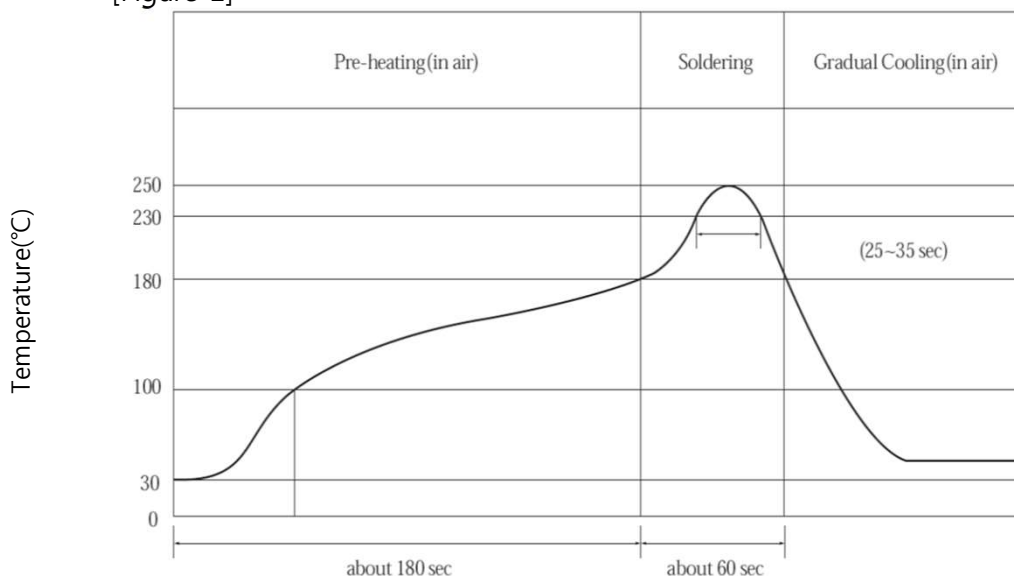

	Chip Trimmer Capacitor	Document No	Rev. No	Page	Rev. Date
		STC3M-SP-14	4	13	13-Jun-19

6.14. Humidity Heat Test

The capacitor shall be measured at the maximum capacitance position.

The chamber temperature shall be kept $40 \pm 2^\circ\text{C}$ with 90~95% RH.

Keep the sample capacitor in the chamber for 48 ± 2 hours.

After then, keep the sample capacitor in normal condition for 2hours before measure it.

6.15. Low Temperature Test

The capacitor shall be measured at the maximum capacitance position.

The chamber temperature shall be kept $-25 \pm 3^\circ\text{C}$. Keep the sample capacitor in the chamber for 48 ± 2 hours.

After then, keep the sample capacitor in normal condition for 2hours before measure it.

6.16. Cleaning Test

The capacitor shall be set approximately maximum capacitance position.

Put the capacitor in toluene, and washer for 10 min

Put the capacitor at the normal condition for drying for 1 hour for measurement.

6.17. Submersion Test

The capacitor shall be set approximately maximum capacitance position.

Put the capacitor in water for 20 min.

Put the capacitor at the normal condition for drying for 2 hour for measurement.

7. PACKING AND REEL DIMENSION

*TAPING SEPCIFICATION

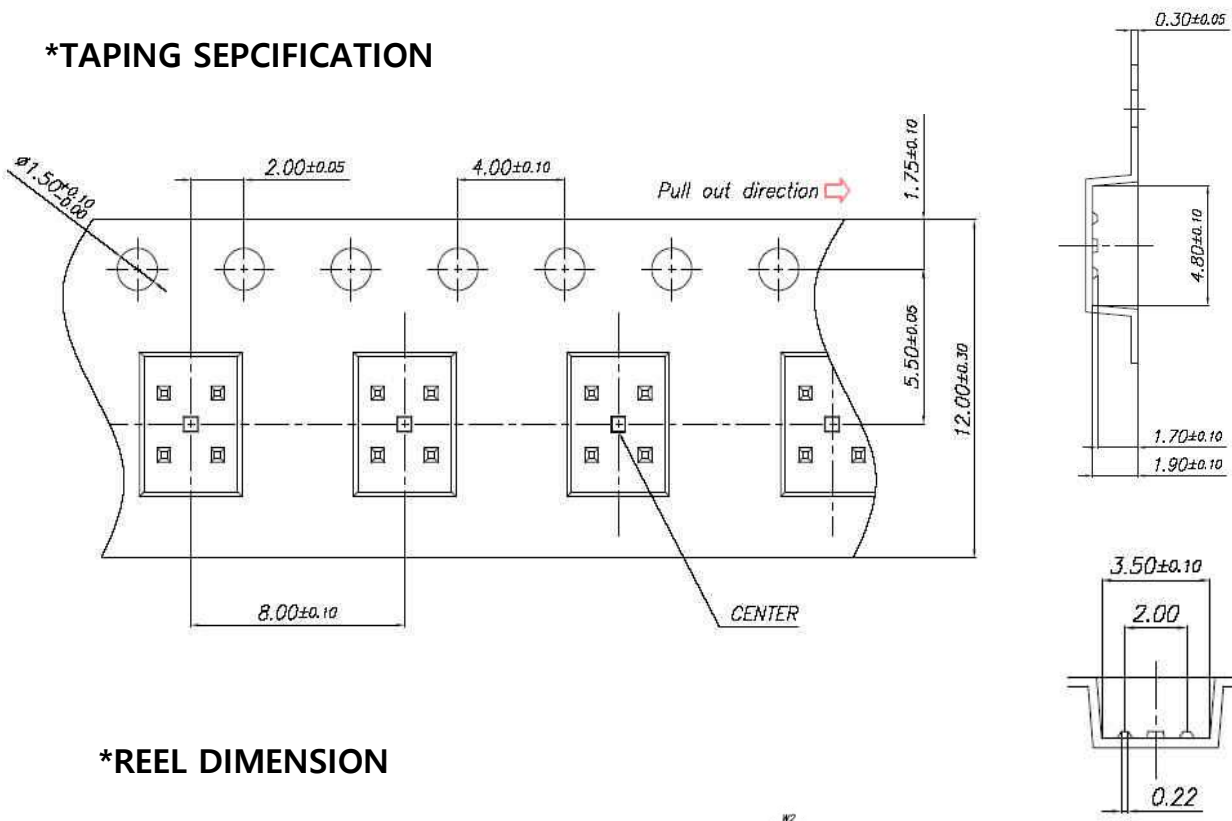

*REEL DIMENSION

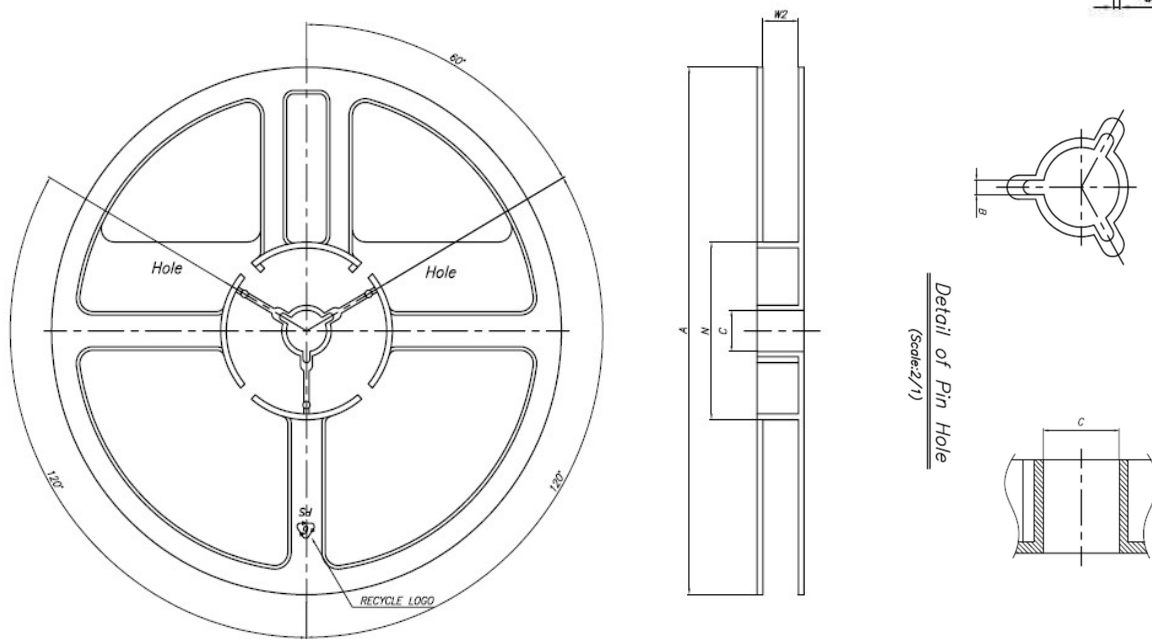

PartNo	A	B	C	N	W2
7"-12mm	178.00 ^{+0.0} _{-2.0}	2.00±0.5	13.00 ^{+0.5} _{-0.2}	60.00 ^{+2.0} _{-0.0}	12.40 ^{+2.0} _{-0.0}

	Chip Trimmer Capacitor	Document No	Rev. No	Page	Rev. Date
		STC3M-SP-14	4	13	13-Jun-19

8. CAUTIONS

Adjustment :

- 1) Maximum pressure of screwdriver should be less than 100g.f
High pressure can lead to extensive setting drift or damage to internal elements.
- 2) Use recommended screwdriver. VESSEL 9000, or the tip of screwdriver shall be insulated such as ceramic.
If a screwdriver is not suitable for trimmer capacitor, it can lead function failure or spoil or degrade the characteristics
- 3) After removing from the reflow soldering, cool it down at the room temperature at least 4 hrs.
If cool down time is insufficient, capacitance drift can be larger due to expansion and shrinkage caused by the heat of resin used for the product, and thermal characteristics of dielectric ceramic.

Soldering :

- 1) Please refer recommended solder profile [Figure-2]. If the soldering conditions are not suitable, the trimmer capacitor may deviate from the specified performances characteristic.
- 2) Please use proper amount of Solder. The amount of solder is critical. Insufficient amounts of solder can lead to insufficient soldering strength on the PCB. Excessive amounts of solder may cause the bridging between the terminals or the contact failure due to flux invasion into the moveable part and contact area.
Flux invasion can cause the degrading of products characteristics.
- 3) Do not touch a trimmer capacitor body and terminal directly by a soldering iron. If soldering iron contacts it, the trimmer capacitor may be seriously damaged.
- 4) Do not use flow-soldering (dipping soldering).
- 5) Do not use inappropriate adhesives, such as bond and instant glue.
It might penetrate into trimmer cap.
- 6) When SEHWA recommended land-pattern is not used, please check mounting alignment

Store :

- 1) It is recommended to use within 6 months after delivery.
- 2) Components should be stored under temperature of -10~40°C and Humidity of 30~70% RH.
- 3) Do not store the trimmer capacitor in corrosive condition.
- 4) Do not open the package until just prior to using
- 5) Do not store under direct sunlight or dewy environment.

Others :

- 1) Before using trimmer capacitors, please test and make prototype product after assembly in your particular mass productions line.
- 2) Do not warp and / or bend PCB to prevent trimmer capacitor from breakage.
- 3) Do not use locking paint or any substance to secure the rotor position.