

N-Channel Enhancement Mode MOSFET

Feature

- 20V/6A, $R_{DS(ON)} = 35m\Omega(MAX)$ @ $V_{GS} = 4.5V$.
 $R_{DS(ON)} = 45m\Omega(MAX)$ @ $V_{GS} = 2.5V$.
- Super High dense cell design for extremely low $R_{DS(ON)}$.
- Reliable and Rugged.
- SC-59 for Surface Mount Package.



SC-59

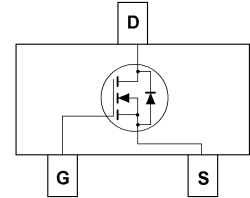

Applications

- LI-ION Protection Circuit

Absolute Maximum Ratings $T_A=25^\circ C$ Unless Otherwise noted

Parameter	Symbol	Limit	Units
Drain-Source Voltage	V_{DS}	20	V
Gate-Source Voltage	V_{GS}	± 10	V
Drain Current-Continuous	I_D	6	A

Electrical Characteristics $T_A=25^\circ C$ Unless Otherwise noted

Parameter	Symbol	Test Conditions	Min	Typ.	Max	Units
Off Characteristics						
Drain to Source Breakdown Voltage	BVDSS	$V_{GS}=0V, I_D=250\mu A$	20	-	-	V
Zero-Gate Voltage Drain Current	IDSS	$V_{DS}=16V, V_{GS}=0V$	-	-	1	μA
Gate Body Leakage Current, Forward	IGSSF	$V_{GS}=10V, V_{DS}=0V$	-	-	100	nA
Gate Body Leakage Current, Reverse	IGSSR	$V_{GS}=-10V, V_{DS}=0V$	-	-	-100	nA
On Characteristics						
Gate Threshold Voltage	$V_{GS(th)}$	$V_{GS}=V_{DS}, I_D=250\mu A$	0.4	-	1.3	V
Static Drain-source On-Resistance	$R_{DS(ON)}$	$V_{GS}=4.5V, I_D=6.0A$	-	28	35	$m\Omega$
		$V_{GS}=2.5V, I_D=5.2A$	-	35	45	$m\Omega$
Drain-Source Diode Characteristics and Maximum Ratings						
Drain-Source Diode Forward Voltage	VSD	$V_{GS}=0V, I_S=1.5A$			1.2	V

Parameter	Symbol	Test Conditions	Min	Typ.	Max	Units
DYNAMIC PARAMETERS						
Input Capacitance	Ciss	VGS=0V, VDS=8V, f=1MHz			800	
Output Capacitance	Coss				155	
Reverse Transfer Capacitance	Crss				125	
SWITCHING PARAMETERS						
Total Gate Charge	Qg	VGS=4V, VDS=10V, ID=4A			11	
Gate Source Charge	Qgs				2.2	
Gate Drain Charge	Qgd				2.5	
Turn-On Delay Time	tD(on)	VGS=4V, VDS=10V, ID=1A, RGEN=10Ω, RI=10Ω			18.3	
Turn-On Rise Time	tr				4.8	
Turn-Off Delay Time	tD(off)				43.5	
Turn-Off Fall Time	tf				20	

**Nanker reserves the right to improve product design, functions and reliability without notice.

Typical Characteristics

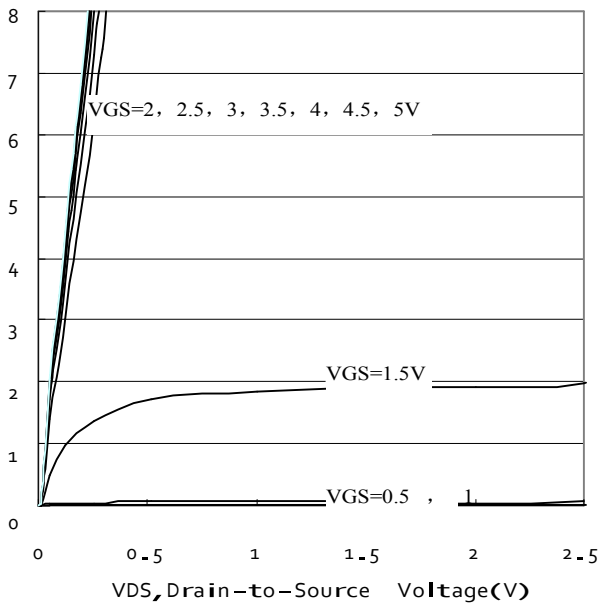

Figure 1. Output Characteristics

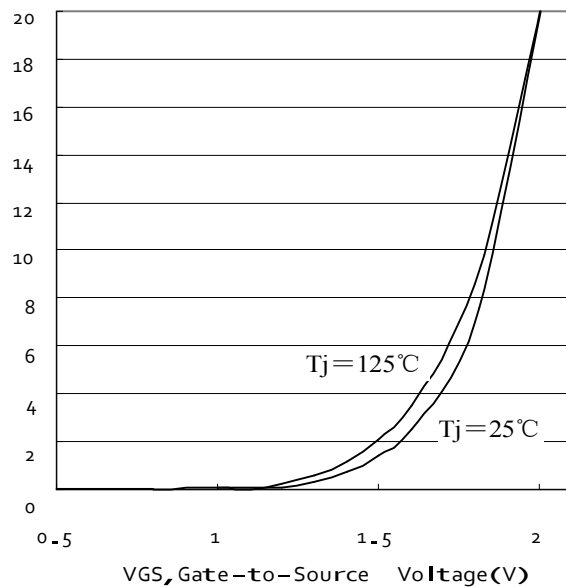

Figure 2. Transfer Characteristics

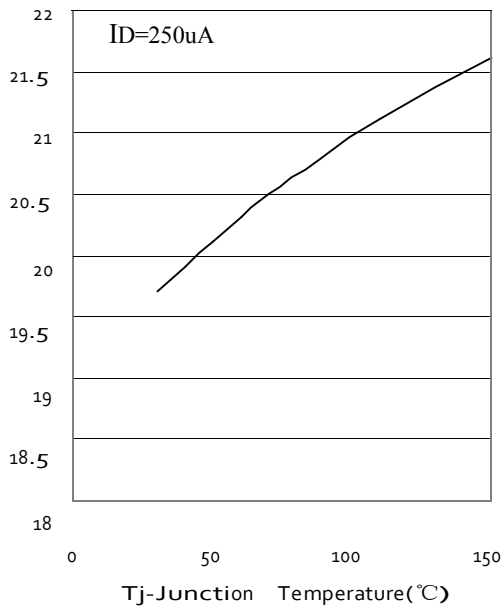

Figure 3. Breakdown Voltage Variation with Temperature

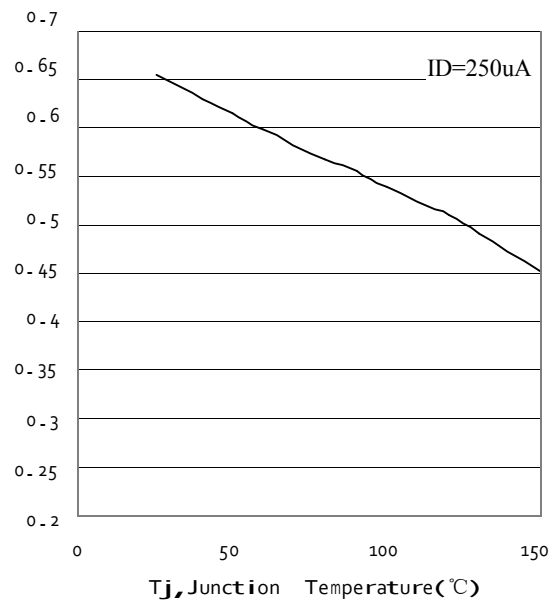

Figure 4. Gate Threshold Variation with Temperature

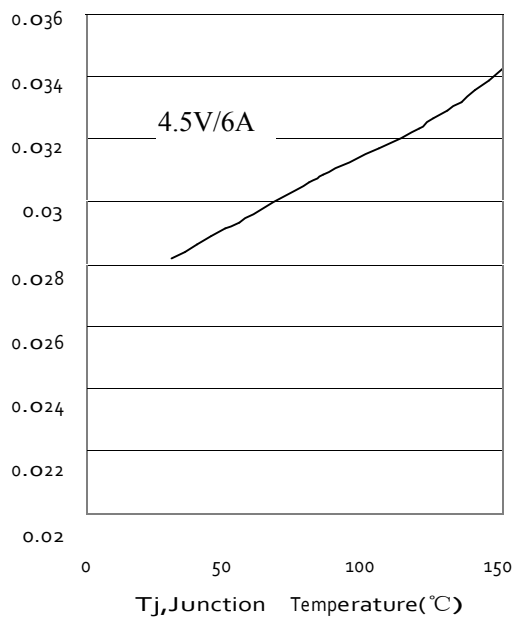

Figure 5. On-Resistance Variation with Temperature

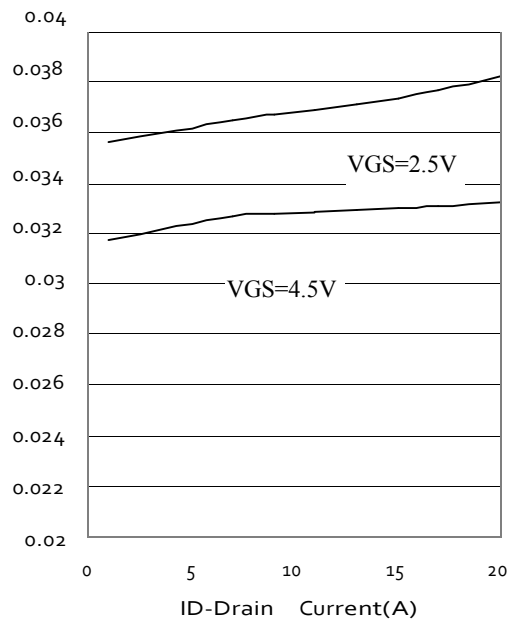

Figure 6. On-Resistance vs. Drain Current

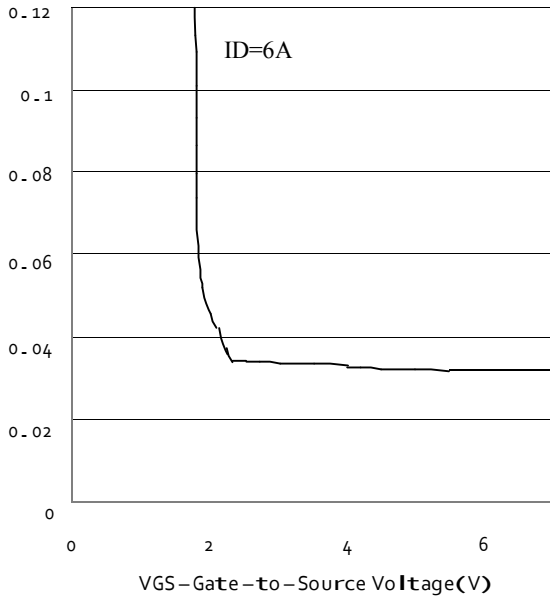

Figure 7. On-Resistance vs. Gate-to-Source Voltage

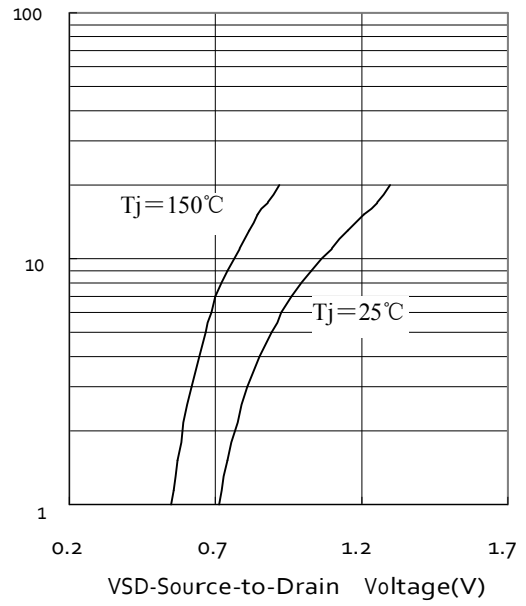

Figure 8. Source-Drain Diode Forward Voltage

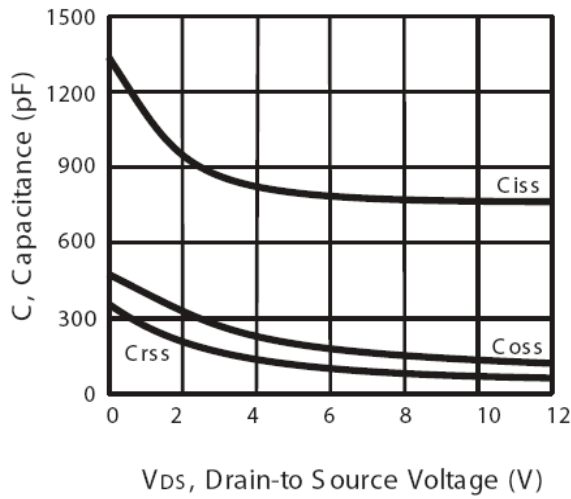

Figure 9. Capacitance

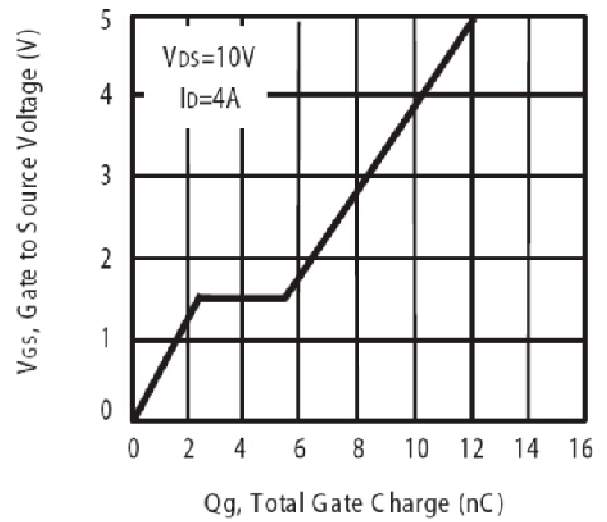

Figure 10. Gate Charge

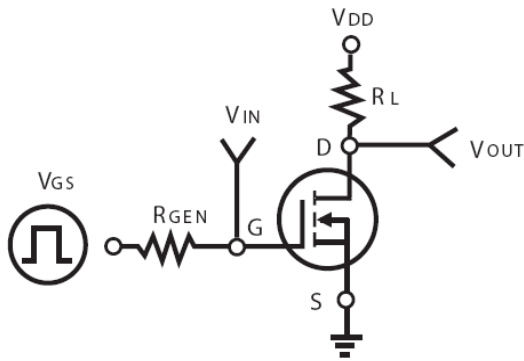

Figure 11. Switching Test Circuit

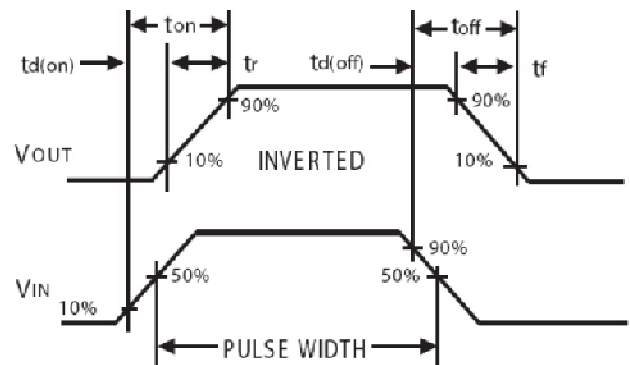

Figure 12. Switching Waveforms

SC-59 Package Outline Dimensions (UNIT: mm)

