

Surface Mount Schottky Barrier Rectifier
Reverse Voltage - 20 to 200V
Forward Current - 5.0A

FEATURES

- Metal silicon junction, majority carrier conduction
- For surface mounted applications
- Low power loss, high efficiency
- High forward surge current capability
- For use in low voltage, high frequency inverters, free wheeling, and polarity protection applications

MECHANICAL DATA

- Case: SMC
- Terminals: Solderable per MIL-STD-750, Method 2026
- Approx. Weight: 0.22g / 0.0077oz

PINNING

| PIN | DESCRIPTION |
|-----|-------------|
| 1 | Cathode |
| 2 | Anode |

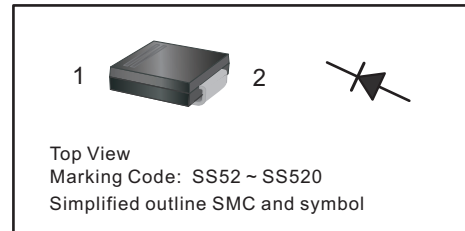

Absolute Maximum Ratings and Electrical characteristics

Ratings at 25 °C ambient temperature unless otherwise specified. Single phase, half wave, 60Hz resistive or inductive load, for capacitive load, derate by 20 %

| Parameter | Symbols | SS52C | SS54C | SS56C | SS58C | SS510C | SS512C | SS515C | SS520C | Units |
|---|-----------------|------------|-------|-------|-------|-----------|--------|--------|--------|-------|
| Maximum Repetitive Peak Reverse Voltage | V_{RRM} | 20 | 40 | 60 | 80 | 100 | 120 | 150 | 200 | V |
| Maximum RMS voltage | V_{RMS} | 14 | 28 | 42 | 56 | 70 | 84 | 105 | 140 | V |
| Maximum DC Blocking Voltage | V_{DC} | 20 | 40 | 60 | 80 | 100 | 120 | 150 | 200 | V |
| Maximum Average Forward Rectified Current | $I_{F(AV)}$ | 5.0 | | | | | | | | A |
| Peak Forward Surge Current, 8.3ms Single Half Sine-wave Superimposed on Rated Load (JEDEC method) | I_{FSM} | 175 | | | | 150 | | | | A |
| Max Instantaneous Forward Voltage at 5 A | V_F | 0.55 | | 0.70 | | 0.85 | | | | V |
| Maximum DC Reverse Current $T_a = 25^\circ\text{C}$ at Rated DC Reverse Voltage $T_a = 100^\circ\text{C}$ | I_R | | | | | 1.0 50 | | | | mA |
| Typical Junction Capacitance ⁽¹⁾ | C_j | 600 | | 400 | | | | | | pF |
| Typical Thermal Resistance ⁽²⁾ | $R_{\theta JA}$ | 35 | | | | | | | | °C/W |
| Operating Junction Temperature Range | T_j | -55 ~ +150 | | | | | | | | °C |
| Storage Temperature Range | T_{stg} | -55 ~ +150 | | | | | | | | °C |

(1) Measured at 1 MHz and applied reverse voltage of 4 V D.C

(2) P.C.B. mounted with 2.0" X 2.0" (5 X 5 cm) copper pad areas.



Fig.1 Forward Current Derating Curve

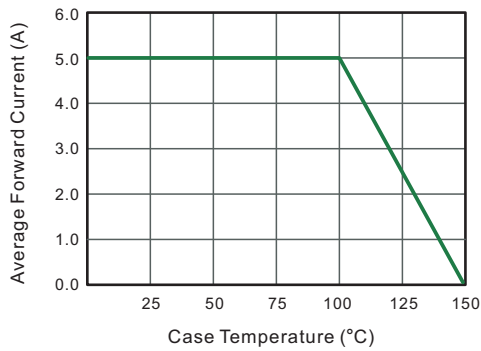

Fig.2 Typical Reverse Characteristics

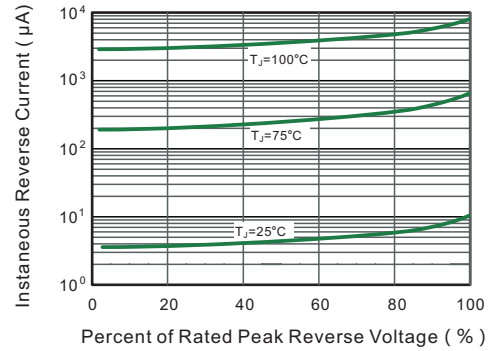

Fig.3 Typical Forward Characteristic

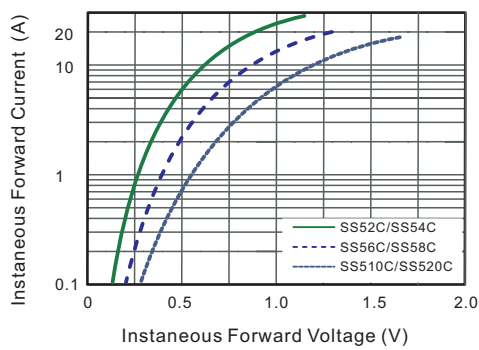

Fig.4 Typical Junction Capacitance

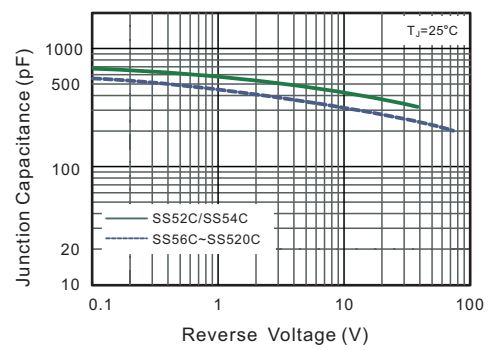

Fig.5 Maximum Non-Repetitive Peak Forward Surge Current

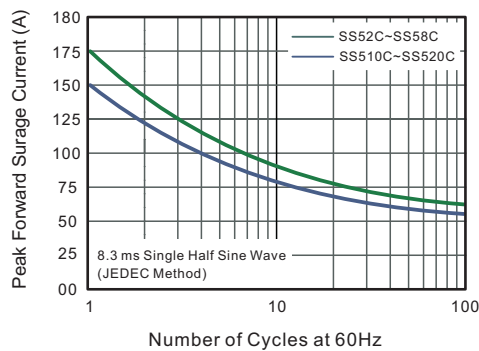
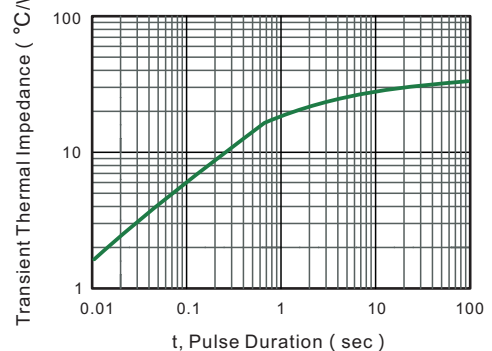

Fig.6- Typical Transient Thermal Impedance





PACKAGE OUTLINE

Plastic surface mounted package; 2 leads

SMC

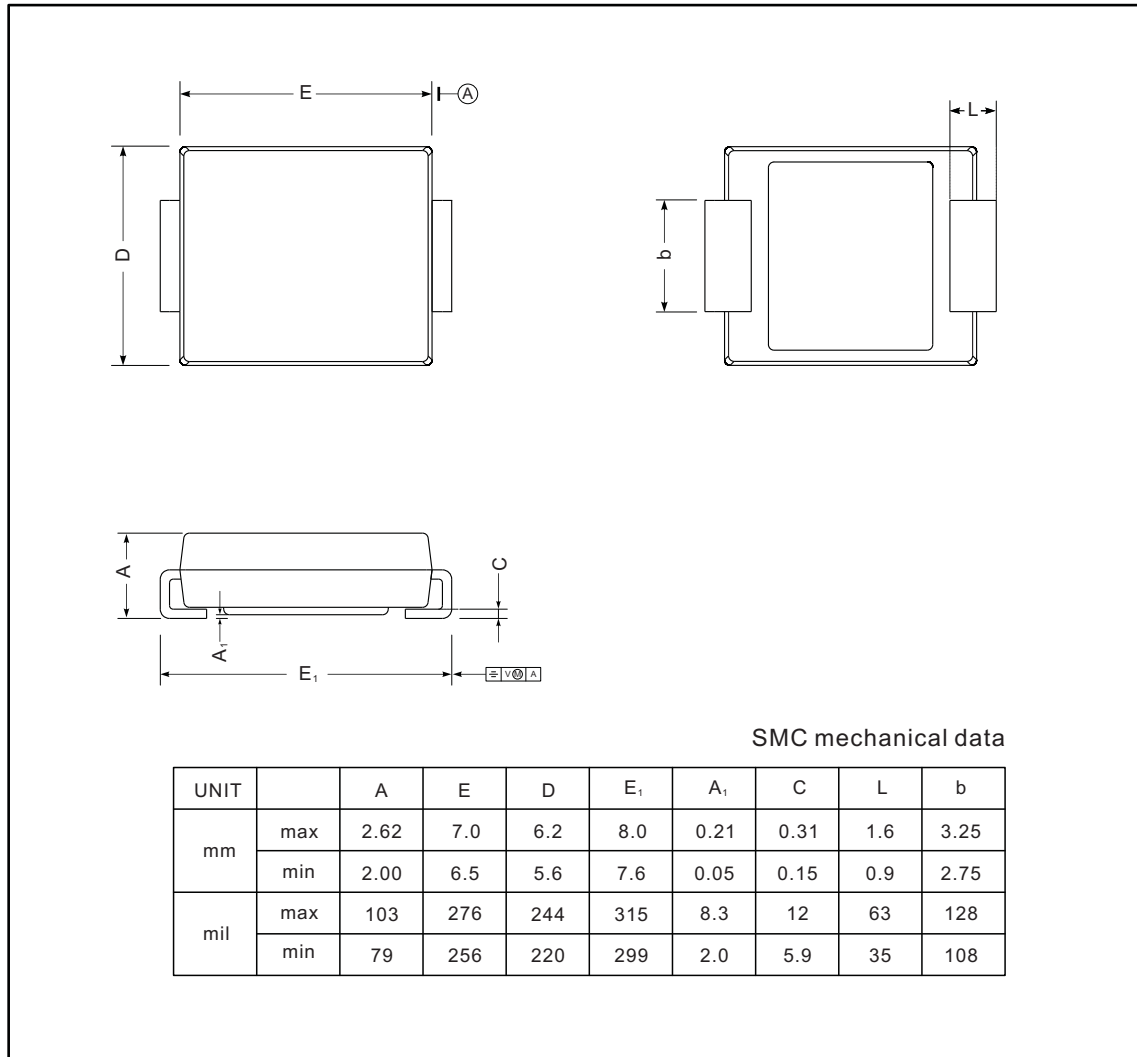

The recommended mounting pad size

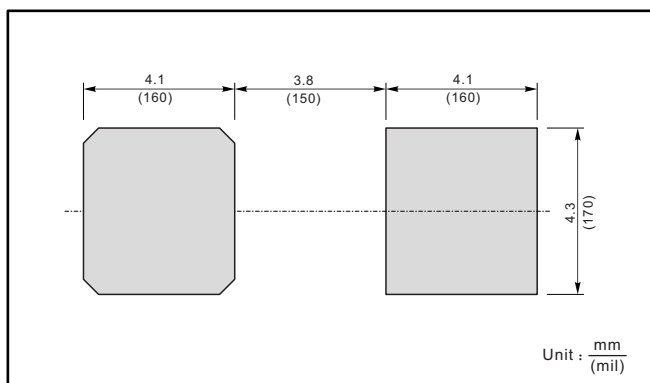

Marking

| Type number | Marking code |
|-------------|--------------|
| SS52C | SS52 |
| SS54C | SS54 |
| SS56C | SS56 |
| SS58C | SS58 |
| SS510C | SS510 |
| SS512C | SS512 |
| SS515C | SS515 |
| SS520C | SS520 |