

時科

讓好產品擁有良芯

SHIKUES MAKES GOOD PRODUCTS EQUIPPED WITH GOOD CHIPS



良芯標準踐行者

CONTENT

目錄

時科品牌

1. 企業簡介 / Company Profile	01 / 02
2. 良芯歷程 / Good Chip History	03 / 04
3. 現代化產品線 / Modern Production Lines	05 / 06
4. 全球化發展戰略 / Global Development Strategy	07
5. 4S良芯標準 / 4S Good Chip Standard	08
6. 參展及行業活動 / Exhibitions and Industry Activities	09 / 10
7. 一站式線上服務平臺 / One-stop Online Service Platform	11
8. 資質認證與設計專利 / Quality Certification and Design Patents	12

時科產品

1. 主要產品 / Main Products	13
2. 產品應用領域 / Product Application Fields	14
3. 客戶應用案例 / Customer Application Cases	15
4. 客戶感言 / Customer Testimonial	16
5. 產品詳細清單 / Product List	17
Low VF肖特基二極管 (Low VF Schottky Diodes)	18
小封裝肖特基 (Small Package Schottky Diodes)	18
肖特基二極管 (Schottky Diodes)	19
普通整流二極管 (General Rectifier Diodes)	27
小信號整流二極管 (Small Signal Rectifier Diodes)	30
快恢復整流管 (Fast Recovery Rectifiers)	30
高效整流管 (High Efficiency Rectifiers)	32
超快恢復整流管 (Super Fast Recovery Rectifiers)	34
3-Pin超快恢復整流管 (3-Pin Super Fast Recovery Rectifiers)	37
橋式整流器 (Bridge Rectifiers)	38
快恢復橋式整流器 (Fast Recovery Rectifier Bridges)	44
高效橋式整流器 (High Efficiency Rectifier Bridges)	46
超快恢復橋式整流器 (Super Fast Recovery Rectifier Bridges)	47
肖特基整流橋 (Schottky Bridges)	47
穩壓二極管 (Zener Diodes)	48
穩壓管 (雙芯片) (Zener Diodes Two Chip)	57
雙向觸發二極管 (Bi-Directional Trigger Diodes)	58
開關二極管 (Switch Diodes)	58
變容二極管 (Variable Capacitance Diodes)	59
PIN二極管 (PIN Diodes)	60
ESD保護管 / TVS (ESD Protection Tube / TVS)	60
瞬態抑制管 (TVS)	61
雙極型晶體管 (Bipolar Transistors)	67
帶阻三極管 (Band-stop Triodes)	71
達林頓三極管 (Darlington Transistors)	72
高頻管 (High Frequency Tube)	72
場效應管 (MOSFETS)	73
高壓場效應管 (High Voltage MOSFETS)	75
低壓差穩壓器 (Low Dropout Voltage Regulator)	76
電源基準IC (Adjustable Accurate Reference Source)	76
三端穩壓IC (Three-Terminal Voltage Regulator IC)	77
硅麥 (Sisonic)	78
鋰電池保護IC (Li-ion Battery Protection)	78

外型尺寸

產品外型尺寸 / Product dimensions

DFN0603	80	SOT-23	86	TSSOP-8	94
SOD-882	80	SC-59	87	SOP-8	94
SOD-923	80	SOT-89	87	MEMS	95
SOD-723	81	SOT-223	88	PDF5060-8	95
SOD-523	81	TO-277	88	DFN2510	96
SOD-323	81	TO-252	89	DFN2*2-6	96
SOD-123	82	UMSB	89	DFN2*2	97
SOD-123FL	82	UMB	90	DFN3.3*3.3	97
SOD-123ST	82	ULBF	90	DFN3*3A-8	98
SOD-80	83	DBF	91	PRPAK5X6	98
DO-213AA	83	ABS	91	TO-220F	99
SMA	83	ABF	91	TO-220	99
SMAF	84	MBS	92	TO-3PNB	100
SMA-HST	84	MBF	92	TO-247	100
SMB	84	DBS	92	KBP	101
SMBF	85	SOT-353	93	KBL	101
SMC	85	SOT23-5	93	GBU	101
SOT-723	85	SOT-363	93	GBJ	102
SOT-523	86	SOT23-6	94	SGBJ	102
SOT-323	86				

環保聲明

產品環保聲明 / Product Environmental Compliance

我們承諾SHIKUES的全部產品系列均符合歐盟RoHS和REACH法規要求。SHIKUES致力於半導體產品的無鹵化，現已具備產品無鹵化能力。

We promise that all series of SHIKUES products are in compliance with EU RoHS and REACH regulations. SHIKUES is dedicated to halogen-free semiconductor products and now has capabilities of halogen-free production.

RoHS 標準受限制物質的最高允許

■ 水銀 (Hg)	0.1%重量	1000ppm
■ 鎘 (cd)	0.01%重量	100ppm
■ 鉛 (pb)	0.1%重量	1000ppm
■ 六價鉻 (cr+6)	0.1%重量	1000ppm
■ 多溴聯苯 (pBB)	0.1%重量	1000ppm
■ 聚合溴化聯苯乙醚 (pBDE)	0.1%重量	1000ppm

RoHS 的免除條款

- 鉛允許作為壹種合金摻雜元素存在於銅中, 重量不可超過4%;在鋼中, 重量不可超過0.35%;在鋁中, 重量不可超過0.4%。
- 鉛允許存在於電子元件的玻璃中。
- 鉛允許存在於電子陶瓷件中。(壓電陶瓷)
- 鉛允許使用在高融溫焊接中 (比如 錫鉛合金含85%以上的鉛)。

COMPANY PROFILE

企業簡介

時科，源自台灣，全球知名的半導體分立元器件廠商之一，主要提供工程師與設計人員各種半導體產品與軟件，為汽車、通信、計算機、消費電子、工業、LED照明、醫療、航空及電源應用等產品帶來更優質的感知體驗。

自創辦以來，在“讓好產品擁有良芯”的核心理念指導下，以安全、低能耗、高性能為宗旨，時科半導體的研發戰略從來沒有動搖過，近四分之一的員工在研發與產品設計領域工作，每年研發費用占總收入的22%左右，加之年輕的、充滿夢想和激情的員工的艱苦奮鬥，時科迅速發展，產品遠銷到北美、歐洲和亞太地區，被認為是半導體行業富有創新力的公司之一。

時科將會在安全、能耗和性能方面不斷優化，更加靈活地滿足設計工程師和不斷變化的市場需求，從概念設計到生產製造，我們將提供全程支持。展望未來，我們將立足創新，不斷為客戶、員工和全社會創造價值，通過降低能耗、改善安全、提升性能，重點關注如何利用技術研發改善公眾生活品質，我們將全力以赴，踐行承諾。

時科半導體是全球工程師的優質戰略合作伙伴。

SHIKUES semiconductor, comes from Taiwan, one of the world's leading semiconductor discrete component manufacturers, provides a variety of semiconductor products and software for engineers and designers. It brings high-quality sensory experience in the field of automotive, communications, computer, consumer electronics, LED lighting, industrial, medical, aerospace and power application.

Since its inception, under the guidance of core philosophy "SHIKUES makes good products equipped with good chips", SHIKUES takes security, low energy consumption, high performance as the purpose. R& D strategy has never been changed, nearly 1/4 employees working in the field of research and development and product design. R & D costs account for around 22% of total revenue every year. In efforts of the young, full of dreams and passion employees, SHIKUES has developed rapidly. The products are exported to North America, Europe and the Asia Pacific region. SHIKUES is considered to be an innovative companies in the semiconductor industry.

SHIKUES will continue to optimize the products in the security, energy consumption and performance, more flexible to satisfy the design engineers and the changing needs of the market, and offer full support from concept design to production. Looking to the future, SHIKUES will continue to create value for customers, employees and the whole society based on innovation. SHIKUES will focus on how to improve quality of people's life by reducing energy consumption, improving security and performance. SHIKUES will go to all lengths to fulfill the promise.

SHIKUES semiconductor is good strategic partner for engineers worldwide.

時科

讓好產品擁有良芯

SHIKUES MAKES GOOD PRODUCTS EQUIPPED WITH GOOD CHIPS



願景 VISION

成為世界一流的半導體分立元器件方案解決商

使命 MISSION

為全球客戶提供"良芯標準"好產品

價值觀 VALUES

產品為王 客戶至上

以"品牌建設"為中心,堅持"品質升級"和"研發創新"兩個基本點

SHIKUES GOOD CHIP HISTORY

時科良芯歷程

創立至今 不斷為良芯使命付諸行動

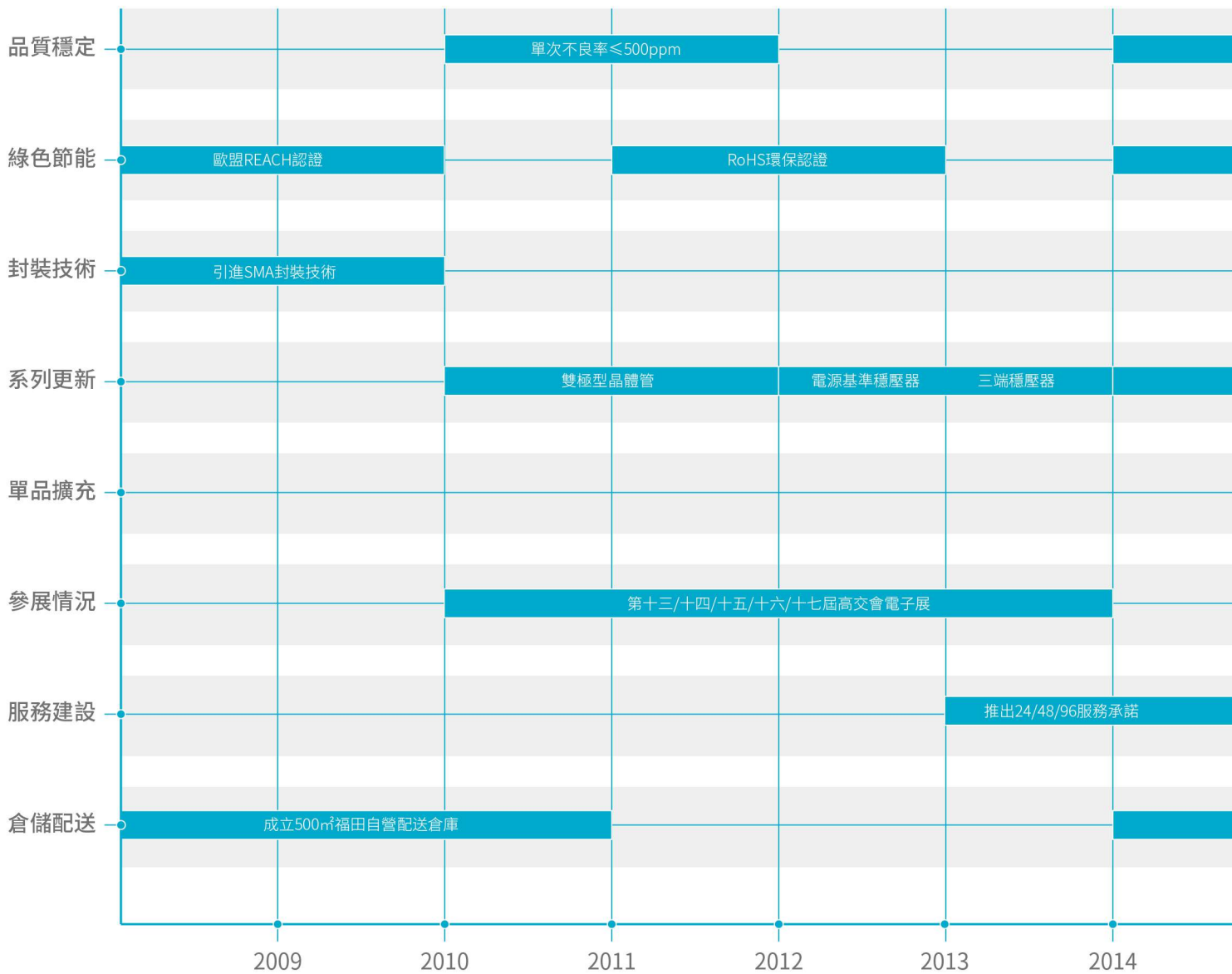

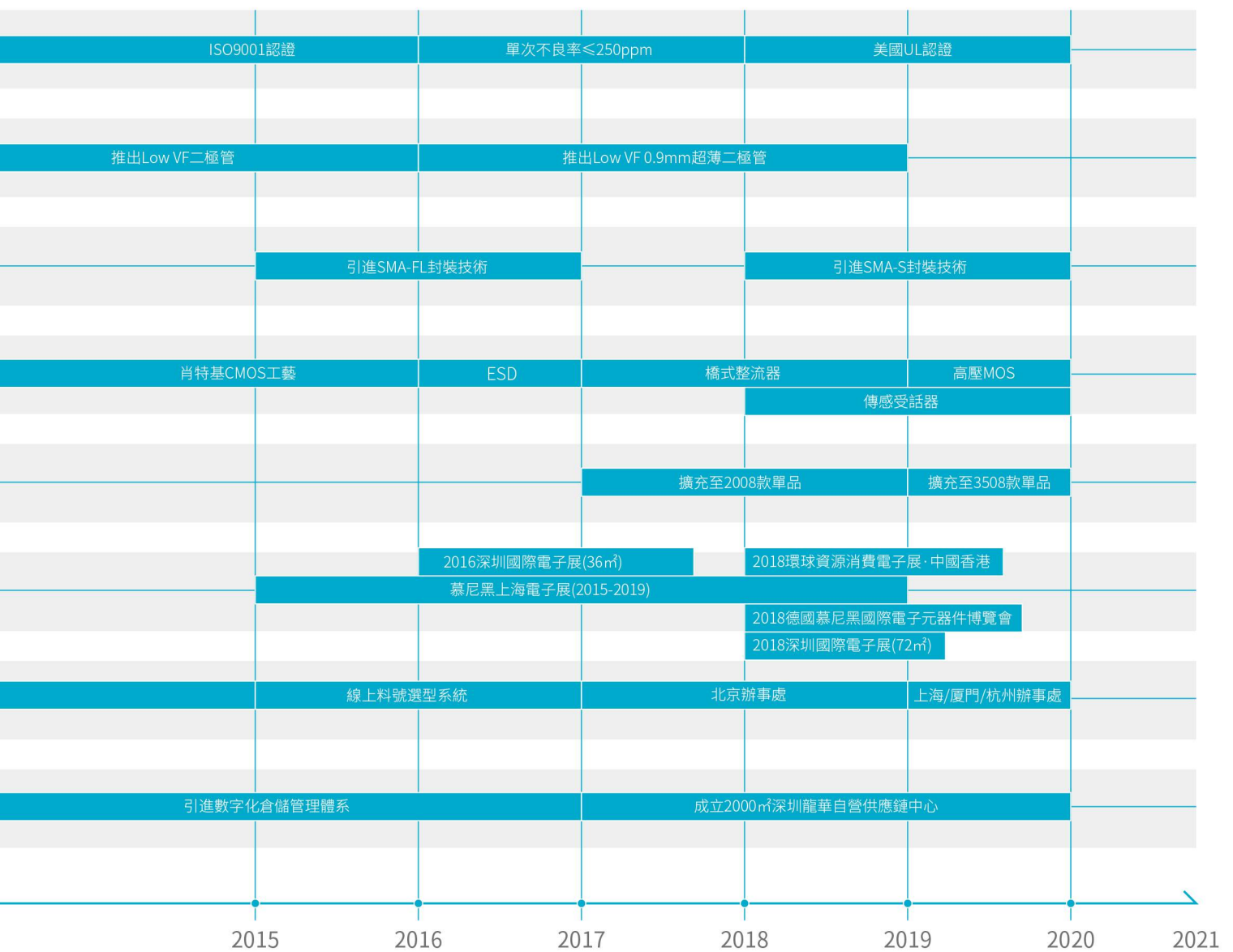

MODERN PRODUCTION LINES

現代化產品線

每年研發投入超總收入的22%

生產研發中心 R&D and Production Center



臺灣晶圓廠
研發設計、知識產權保護中心
Taiwan Wafer Factory
R&D, Design and Intellectual Property
Protection Center



產線
芯片生產線
Production line
Chip Production Line



封測產線
Production Line
Assembly and Test Line



生產現場流程圖 Production Site Flow Chart

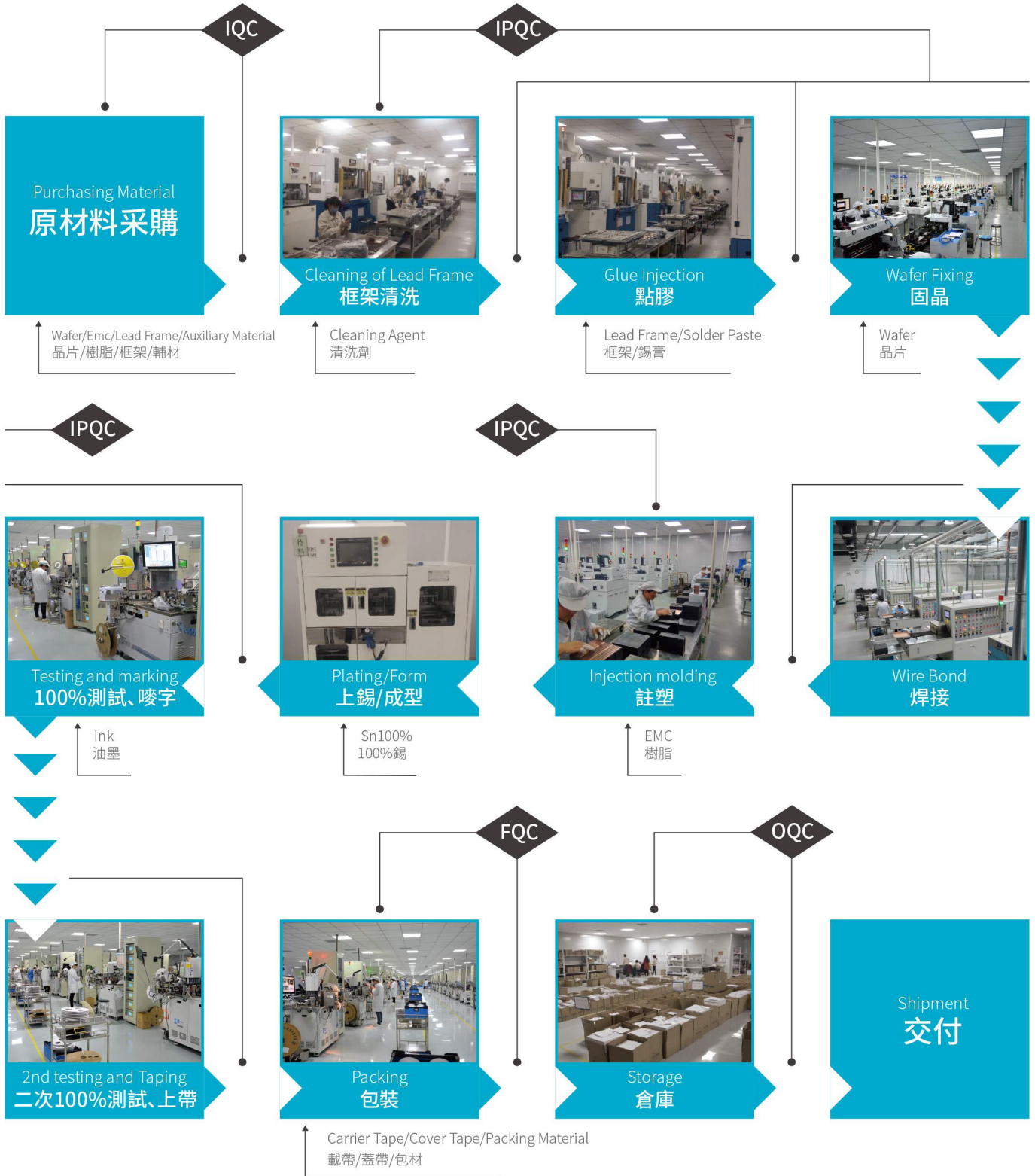

GLOBAL DEVELOPMENT STRATEGY

全球化發展戰略

深耕大陸一線和沿海發達城市 銷售網絡遍及全球50餘個國家

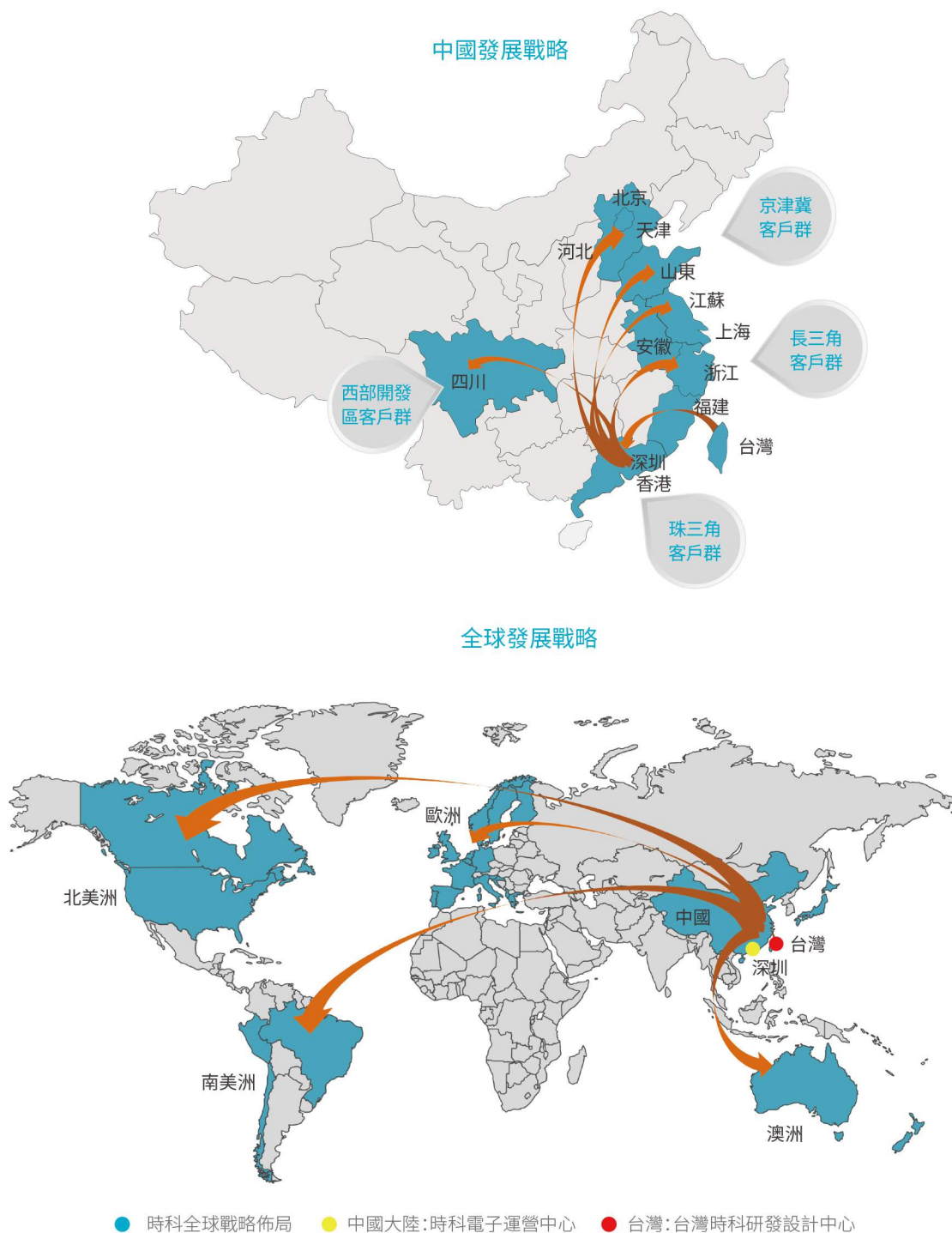

4S GOOD CHIP STANDARD

4S良芯標準

選時科 就是選良芯



良芯·體系 (System)	高性能: SMA-S高散熱封裝技術			
	低能耗: Low VF超薄二極管系列產品			
	安 全: RoHs/ISO/REACH/UL四重質量認證			
良芯·支持 (Support)	100%正品保證	全時配送系統	專項價格政策	線上快速選型
	官方原廠統壹出品、配送、服務	自營供應鏈中心、數字化管理、響應突發需求	為滿足條件的客戶提供更具優勢的價格	APP、京東商城、公眾號、官方網站
	產品線齊全	專項供貨政策	特殊定制需求	技術交流活動
	涵蓋16個產品類目、近4000款單品	珠三角免費送貨上門、鑽石客戶優先供貨	根據“客戶產品方案”提供個性化定制	每年2-4次行業技術交流研討會(免費)
良芯·服務 (Service)	需求快速回應	壹站式技術支持	實時報備系統	分銷激勵制度
	24h溝通/48h解決/96h未解決全款退貨	協助選型、解決相關疑難雜癥、跟進定制需求	為“授權經銷商”提供專人實時報備查詢	為不同級別的分銷商提供相應的激勵制度
	專屬貨品管理	產品名錄更新	售後及時回訪	誠信合作守則
	根據客戶需求,對貨品進行專人專項管理	每年提供1-2次產品名錄更新	電話、線上QQ、上門拜訪等多種方式	真誠待客、陽光採購、信守承諾
良芯·監督 (Supervision)	說到做到,嚴格恪守上述標準			
	接受每壹位客戶或同行朋友投訴監督(總經理郵箱:gm@shikues.com)			

EXHIBITIONS AND INDUSTRY ACTIVITIES

參展及行業活動

良芯品質, 全球供應

線下營銷

慕尼黑上海電子展(2015-2020)



2018德國慕尼黑國際電子元器件博覽會



深圳國際電子展(2016-2020)

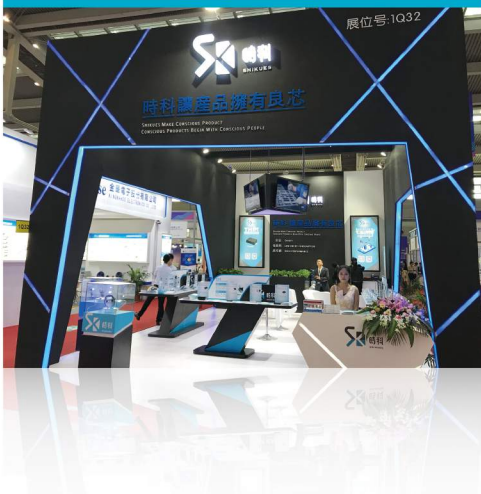

環球資源消費電子展·中國香港(2018-2019)

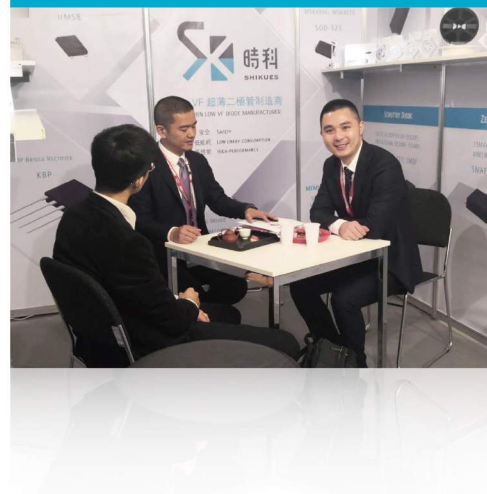

國內展會名稱	時間	面積(平方米)	參加地點
慕尼黑上海電子展	2015年—2017年	36	上海
	2018年—2020年	54	上海
第十三屆—第十七屆高交會電子展	2011年—2015年	18	深圳
2017深圳國際電子展暨嵌入式系統展	2017年12月	36	深圳
深圳國際電子展	2016年12月	36	深圳
深圳國際電子展	2018年—2020年	72	深圳
廣州國際照明展	2019年-2020年	9	廣州

國內展會名稱	時間	面積(平方米)	參加地點
2017慕尼黑(印度)電子元器件及生產設備展覽會	2017年9月14-16	9	印度 新德里
2018環球資源(春季)消費電子展	2018年4月11-14	9	中國 香港
2018環球資源(秋季)消費電子展	2018年10月11-14	9	中國 香港
2018德國慕尼黑國際電子元器件博覽會electronica	2018年11月13-16	9	德國 慕尼黑
2019環球資源(春季)消費電子展	2019年4月11-14	18	中國 香港
2019FIEE巴西國際電力展	2019年7月23-26	9	巴西 聖保羅
2019越南電子元器件、材料及生產設備展	2019年9月11-13	9	越南 河內

2021年展會預告	時間	面積(平方米)	參加地點
慕尼黑上海電子展	2021年4月14-16	54	上海
廣州國際照明展	2021年6月9-12	9	廣州
深圳國際電子展	2021年9月1-3	72	深圳

QUALITY CERTIFICATES AND DESIGN PATENTS

資質認證與設計專利

四重國內外質量認證 為良芯品質保駕護航



生產及運營流程管控
符合ISO9001:2015標準

全系列產品均通過歐盟ROHS,REACH,鹵素檢測,符合標準要求

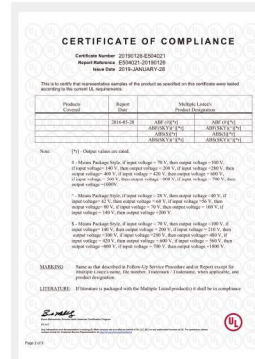
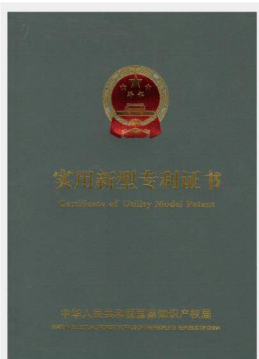

(UL認證)

ONE-STOP ONLINE SERVICE PLATFORM

一站式線上服務平臺

和網購一般方便的選型體驗



a. 輕鬆獲取產品資訊; b. 資質認證一目了然; c. 高效定制料號參數; d. 即時申領產品樣片

更提供多種方式任您選擇:



a. 時科公眾號; b. 時科官方網站; c. 時科APP

MAIN PRODUCTS

主要產品



SOD-123FL



SOT-89



SOT-23



TO-252

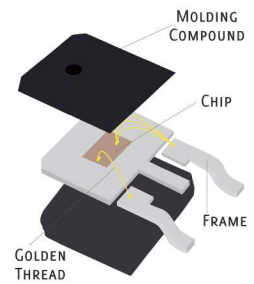
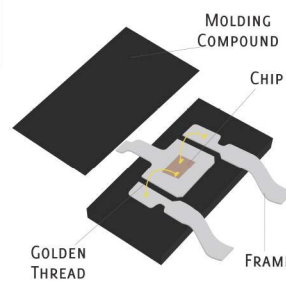
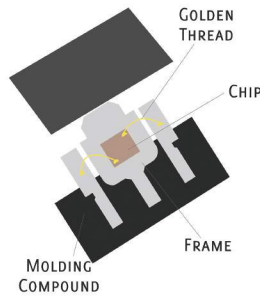
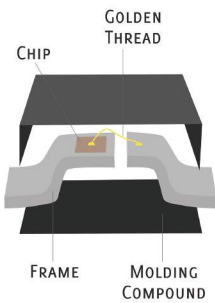

主營產品 Main Product

Low VF肖特基二極管, 普通整流二極管, 快恢復整流管, 高效整流管, 超快恢復整流管, 肖特基二極管, 穩壓二極管, 穩壓管 (雙芯片), 開關二極管, 雙向觸發二極管, 變容二極管, 瞬態抑制管, ESD保護管, 橋式整流器, 雙極型晶體管, 場效應管, 三端穩壓IC, 電源基準IC

Low VF schottky diodes, general rectifier diodes, fast recovery rectifiers, high efficiency rectifiers, super fast rectifiers, schottky diodes, zener diodes, zener diodes two chips, switch diodes, bi-directional trigger diodes, vhf variable capacitance diodes, transient voltage suppressors, ESD protection tubes, bridge rectifiers, bipolar transistors, mosfets, three-terminal voltage regulator IC, adjustable accurate reference sources.

主營封裝線 Package List

SMAF	SOD-123	SOT-23	DO-214AC(SMA)	TO-277	LL-34
SMBF	SOD-323	SOT-323	DO-214AA(SMB)	TO-252	GBU
MBS	SOD-523	SOT-223	DO-214AB(SMC)	TO-220	KBP
MBF	SOD-723	SOT-89		TO-220F	DFN0603
ABS	SOD-882			TO-247	DFN3X3A-8
UMB	SOD-923			TO-247G	PDF5060-8
UMSB	SOD-123FL				

超薄新品 Ultra-thin New Product

LowVF系列

MSK4005
MSK4010
MSK240AW
MSK340A

TO-252新品

SK04N65B
SK07N65B
SK08N65B
SK10N65B
SK30N65B

肖特基二極管

SS24FL-SS26FL
SS34FL
SS54FL-SS56FL
SS12F-SS110F

整流二極管

1N4001F-1N4007F
S3AF-S3MF

快恢復二極管

RS1AF-RS1MF
RS2AF-RS2MF
RS3AF-RS3MF

超快恢復二極管

ES3AF-ES3JF

高效恢復二極管

US3AF-US3MF

橋式整流器

LUM1B-LUM10B
MSB30B-MSB30M
GBU系列
KBP系列
MB1F系列
MB1S系列
ABS1系列

PRODUCT APPLICATION FIELDS

產品應用領域

電源管理 POWER MANAGEMENT



Products產品:

Integrated circuit 集成電路
Switch diodes 開關二極管
Rectifier diodes 整流二極管
Transistors 三極管
Zener diodes 穩壓二極管

Applications應用:

UPS equipment 不間斷電源設備
Power control & Management 電源控制管理
Subway equipment 地/高鐵設備應用

IOT & 智能家居 IOT & SMART HOME



Products產品:

Zener diodes 齊納
Three terminal regulator ICS 三端穩壓IC
Switch diodes 開關二極管
ESD protection tubes SOD-923 ESD保護管
Schottky diodes 肖特基二極管
Rectifiers 整流二極管
Bridge rectifiers 橋堆
Switch transistors SOT-23 開關三極管

Applications應用:

Temperature controller 溫控器
Counter 計數器
Pressure sensor 壓力傳感器 WLAN設備
Linear hall-effect sensors 線性霍爾傳感器
Fingerprint control door lock 指紋門鎖
Home intelligent gateway 家用智能網關
Bluetooth device 藍牙設備
Robot cleaner 掃地機器人

LED照明 LED LIGHTING



Products產品:

MOSFETS 場效應管
Schottky diodes 肖特基二極管
Transistors 三極管
Zener diodes 穩壓二極管
Switch diodes 開關二極管

Applications應用:

Indoor lighting 室內
LED bulb LED tube 球泡
Exterior lighting 室外
Landscape lighting 景觀照明
Large buildings lighting 大型建築物照明

電機驅動器 MOTOR DRIVER



Products產品:

MOSFETS 場效應管
Transistors 三極管
Zener diodes 穩壓二極管
ESD protection tubes ESD保護管

Applications應用:

Medical instruments and equipment 醫療儀器及設備
industrial control system 工業控制系統
intelligent remote control curtain 智能遙控窗簾
3D Printing equipment 3D打印設備
Robot cleaner 掃地機器人

消費電子 CONSUMER ELECTRONICS



Products產品:

Bridge rectifiers 橋式整流器
Zener diodes 穩壓二極管
Low VF schottky diodes SMAF 低壓肖特基二極管
ESD protection tubes ESD保護管
MOSFETS 場效應管
Band-stop triodes 帶阻三極管

Applications應用:

iPad 平板 Smartphone 智能手機
Bluetooth device 藍牙設備
WIFI device 無線路由/交換機
Power bank 移動電源
Electric toothbrush 電動牙刷
UAV 無人機 Smart watch 智能手表

CUSTOMER APPLICATION CASES

客戶應用案例

客戶見證

通訊類



HUAWEI



GREE 格力



JCG

電源類

GOODO



PHILIPS



柏克新能
智領全球產業源動力

TIGIDIGITAL

MOSO[®]



P-DUKE
POWER



DELTA 台達
中達電通股份有限公司

電子
產品類



科大訊飛
iFLYTEK

TAKSTAR[®]

SUNWODA
欣旺達

其他類



P/EMT

ADEL[®]

CUSTOMER TESTIMONIAL

客戶感言

與柏克合作五年來,時科產品通過柏克組合,銷往世界各地,在各個不同領域,取得了舉足輕重的作用。產品用於壹帶壹路;武廣、廈深、滬昆、蘭新等十幾條高鐵線。五年合作裏,柏克與時科深度的合作,用時科良芯的芯片做良心的產品,在電源行業取得驕人的成績。

In the past five years of cooperation with Baykee, SHIKUES products have been sold all over the world through combination with Baykee products and have played an decisive role in various fields. The products are used in projects in “One Belt One Road”; in a dozen high-speed railway lines including Wuhan-Guangzhou line, Xiamen-Shenzhen line, Shanghai-Kunming line and Lanzhou-Xinjiang line. In the five years deep cooperation, Baykee has made remarkable achievements in the power industry using SHIKUES good chip products.



航天柏克(廣東)科技有限公司
葉德明 採購總監

時科擁有高效的技術與服務團隊,協助料號選型也非常專業。對我們特殊定制需求也跟進得非常細心。例如他們推出的“全球超薄LOW VF整流二極管”厚度超薄達到了0.9毫米級別,非常適合壹些小型超薄產品中,更重要的是他們為我們提供了及其快捷高效的物流配送支持,應對突發需求,也能在最短時間內響應,這點對於我們科技企業來說,非常重要也非常關鍵。

SHIKUES has an efficient technical and service team, and is also very professional to assist in material selection. They also provide very careful follow-up services to special customization requirements. For example, the global ultra-thin low VF rectifier diode launched by them is 0.9mm thick, which is very suitable for some small ultra-thin products. More importantly, SHIKUES provides us with fast and efficient logistics and distribution support to meet the sudden demand and respond in the shortest time, which is very important and critical for our science and technology enterprises.



深圳市盛思達通訊技術有限公司
徐意鋒 副總經理



PRODUCT LIST

產品線詳細清單

時科
讓好產品擁有良芯

LOW VF SCHOTTKY DIODES

Low VF肖特基二極管

PARAMETER TYPE 參數 型號	VRRM	I(AV)	IFSM	VF		IR		Package
					IF		VR	
				V	A	mA	V	
SS12FL	20	1	40	0.45	1	0.3	20	SMAF
SS14FL	40	1	40	0.45	1	0.2	40	SMAF
SS16FL	60	1	40	0.5	1	0.2	60	SMAF
SS24FL	40	2	50	0.45	2	0.5	40	SMAF
SS26FL	60	2	40	0.52	2	0.3	60	SMAF
SS34FL	40	3	80	0.45	3	0.3	40	SMAF
SS36FL	60	3	80	0.55	3	0.3	60	SMAF
SS54FL	40	5	150	0.45	5	1	40	SMAF
SS56FL	60	5	150	0.55	5	1	60	SMAF
MSK340A	45	5		0.3(Typ)	1	0.1	45	SMA
SKM32-AS	20	3	80	0.38	3	1	20	SMA-HST
SKM33-AS	30	3	80	0.4	3	1	30	SMA-HST
SKM34-AS	40	3	80	0.4	3	1	40	SMA-HST
SS210LBG	100	2	50	0.6	2	1	100	SMB
SS34LBG	40	3	80	0.5	3	0.5	40	SMB
SS310LBG	100	3	80	0.6	3	0.3	100	SMB
SS545LBG	45	5	150	0.45	5	1	45	SMB
SS510LBG	100	5	150	0.6	5	1	100	SMB
SS54BFL	40	5	130	0.45	5	0.3	40	SMBF
SK14WAL	40	1	30	0.45	1	0.2	40	SOD-123FL
SK16WAL	60	1	30	0.5	1	0.2	60	SOD-123FL
SK24WAL	40	2	50	0.45	2	0.5	40	SOD-123FL
SK26WAL	60	2	50	0.5	2	0.3	60	SOD-123FL
MSK240AW	45	3		0.34(Typ)	1	0.2	45	SOD-123FL
SL1045DS	45	10	150	0.5	10	0.05	45	TO-252
SL10100DS	100	10	150	0.65	10	0.05	100	TO-252
SK10U45LA	45	10	150	0.51	10	0.1	45	TO-277
SK10U45MA	45	10	150	0.5	10	0.1	45	TO-277
SK10U60AA	60	10	600	0.51	10	0.05	60	TO-277
SK10U60AAP	60	10	300	0.505	10	0.07	60	TO-277
SK10U100AA	100	10	200	0.65	10	0.05	100	TO-277
SK15U60AA	60	15	300	0.51	15	0.05	60	TO-277
SK15U100AA	100	15	350	0.7	15	0.05	100	TO-277

SMALL PACKAGE SCHOTTKY DIODES

小封裝肖特基

PARAMETER TYPE 參數 型號	VRRM	I(AV)	IFSM	VF		IR		Package
					IF		VR	
				V	A	μA	V	
RB551V-30	30	0.5	2	0.54	0.5	100	20	SOD-323
BAT60B	10	3		0.6	100	25	8	SOD-323

TYPE 型號	PARAMETER 參數	VRRM	I(AV)	IFSM	VF		IR		Package
						IF		VR	
					V	A	μA	V	
MSK4005		40	0.5	1	0.5	0.5	70	20	SOD-523
MSK4010		40	1	2	0.56	1	70	40	SOD-523
MSK4005D		40	0.5		0.52	0.5	50	40	SOD-882
MSK4010D		40	1		0.58	1	100	40	SOD-882

SCHOTTKY DIODES

肖特基二極管

TYPE 型號	PARAMETER 參數	VRRM	I(AV)	IFSM	VF		IR		Package
						IF		VR	
					V	A	mA	V	
SS12F		20	1	40	0.55	1	0.3	20	SMAF
SS14F		40	1	40	0.55	1	0.3	40	SMAF
SS16F		60	1	40	0.7	1	0.3	60	SMAF
SS18F		80	1	40	0.7	1	0.3	80	SMAF
SS110F		100	1	30	0.85	1	0.2	100	SMAF
SS112F		120	1	30	0.85	1	0.2	120	SMAF
SS115F		150	1	30	0.9	1	0.1	150	SMAF
SS120F		200	1	30	0.9	1	0.1	200	SMAF
SS22F		20	2	50	0.55	2	0.5	20	SMAF
SS24F		40	2	50	0.55	2	0.5	40	SMAF
SS26F		60	2	50	0.7	2	0.5	60	SMAF
SS28F		80	2	50	0.7	2	0.5	80	SMAF
SS210F		100	2	40	0.85	2	0.3	100	SMAF
SS212F		120	2	40	0.85	2	0.3	120	SMAF
SS215F		150	2	40	0.95	2	0.3	150	SMAF
SS220F		200	2	40	0.95	2	0.3	200	SMAF
SS32F		20	3	80	0.55	3	0.5	20	SMAF
SS34F		40	3	80	0.55	3	0.5	40	SMAF
SS36F		60	3	80	0.7	3	0.3	60	SMAF
SS38F		80	3	80	0.7	3	0.3	80	SMAF
SS310F		100	3	70	0.85	3	0.3	100	SMAF
SS312F		120	3	70	0.85	3	0.3	120	SMAF
SS315F		150	3	70	0.95	3	0.3	150	SMAF
SS320F		200	3	70	0.95	3	0.3	200	SMAF
SS52F		20	5	150	0.45	5	1	20	SMAF
SS54F		40	5	150	0.55	5	1	40	SMAF
SS56F		60	5	150	0.7	5	1	60	SMAF
SS58F		80	5	150	0.7	5	1	80	SMAF
SS510F		100	5	150	0.85	5	1	100	SMAF
SS512F		120	5	150	0.85	5	1	120	SMAF
SS515F		150	5	150	0.85	5	1	150	SMAF
SS520F		200	5	150	0.85	5	1	200	SMAF
SS22BF		20	2	55	0.55	2	0.5	20	SMBF
SS24BF		40	2	55	0.55	2	0.5	40	SMBF
SS26BF		60	2	55	0.7	2	0.5	60	SMBF
SS210BF		100	2	45	0.85	2	0.3	100	SMBF
SS215BF		150	2	45	0.95	2	0.3	150	SMBF
SS220BF		200	2	45	0.95	2	0.3	200	SMBF

TYPE 型號	PARAMETER 參數	V _{RRM}	I(AV)	I _{FSM}	V _F		I _R		Package
						I _F		V _R	
					V	A	mA	V	
SS32BF	20	3	80	0.55	3	0.5	20	SMBF	
SS34BF	40	3	80	0.55	3	0.5	40	SMBF	
SS36BF	60	3	80	0.7	3	0.5	60	SMBF	
SS310BF	100	3	70	0.85	3	0.3	100	SMBF	
SS315BF	150	3	70	0.95	3	0.3	150	SMBF	
SS320BF	200	3	70	0.95	3	0.3	200	SMBF	
SS52BF	20	5	150	0.45	5	1	20	SMBF	
SS54BF	40	5	150	0.55	5	1	40	SMBF	
SS56BF	60	5	150	0.7	5	1	60	SMBF	
SS510BF	100	5	150	0.85	5	1	100	SMBF	
SS520BF	200	5	150	0.85	5	1	200	SMBF	
B120AG	20	1	30	0.5	1	0.5	20	SMA	
B130AG	30	1	30	0.5	1	0.5	30	SMA	
B140AG	40	1	30	0.5	1	0.5	40	SMA	
B150AG	50	1	30	0.7	1	0.5	50	SMA	
B160AG	60	1	30	0.7	1	0.5	60	SMA	
SK12G	20	1	30	0.5	1	0.5	20	SMA	
SK13G	30	1	30	0.5	1	0.5	30	SMA	
SK14G	40	1	30	0.5	1	0.5	40	SMA	
SK15G	50	1	30	0.7	1	0.5	50	SMA	
SK16G	60	1	30	0.7	1	0.5	60	SMA	
SK18G	80	1	30	0.85	1	0.5	80	SMA	
SK110G	100	1	30	0.85	1	0.5	100	SMA	
SS12G	20	1	40	0.55	1	0.5	20	SMA	
SS14G	40	1	40	0.55	1	0.5	40	SMA	
SS16G	60	1	40	0.7	1	0.5	60	SMA	
SS18G	80	1	40	0.7	1	0.5	80	SMA	
SS110G	100	1	40	0.85	1	0.5	100	SMA	
B220AG	20	2	50	0.5	2	0.5	20	SMA	
B230AG	30	2	50	0.5	2	0.5	30	SMA	
B240AG	40	2	50	0.5	2	0.5	40	SMA	
B250AG	50	2	50	0.7	2	0.5	50	SMA	
B260AG	60	2	50	0.7	2	0.5	60	SMA	
SS22G	20	2	50	0.55	2	0.5	20	SMA	
SS24G	40	2	50	0.55	2	0.5	40	SMA	
SS26G	60	2	50	0.7	2	0.5	60	SMA	
SS28G	80	2	50	0.85	2	0.5	80	SMA	
SS210G	100	2	50	0.85	2	0.5	100	SMA	
B320AG	20	3	100	0.5	3	0.5	20	SMA	
B330AG	30	3	100	0.5	3	0.5	30	SMA	
B340AG	40	3	100	0.5	3	0.5	40	SMA	
B350AG	50	3	100	0.7	3	0.5	50	SMA	
B360AG	60	3	100	0.7	3	0.5	60	SMA	
SS32G	20	3	80	0.55	3	0.5	20	SMA	
SS34G	40	3	80	0.55	3	0.5	40	SMA	
SS36G	60	3	80	0.7	3	0.5	60	SMA	
SS38G	80	3	80	0.7	3	0.5	80	SMA	
SS310G	100	3	70	0.85	3	0.5	100	SMA	
SS312G	120	3	70	0.85	3	0.3	120	SMA	
SS315G	150	3	70	0.95	3	0.3	150	SMA	
SS320G	200	3	70	0.95	3	0.3	200	SMA	
RB051L-40	40	2	50	0.55	2	0.5	40	SMA	
RB050L-40	40	3	100	0.55	3	0.5	40	SMA	
SS52G	20	5	120	0.55	5	1	20	SMA	
SS54G	40	5	120	0.55	5	1	40	SMA	
SS56G	60	5	120	0.7	5	1	60	SMA	
SS58G	80	5	120	0.7	5	1	80	SMA	
SS510G	100	5	100	0.85	5	1	100	SMA	

TYPE 型號	PARAMETER 參數	VRRM	I(AV)	IFSM	VF		IR		Package
						IF		VR	
					V	A	mA	V	
SS512G	120	5	100	0.85	5	1	120	SMA	
SS515G	150	5	100	0.85	5	1	150	SMA	
SS520G	200	5	100	0.85	5	1	200	SMA	
SK22BG	20	2	50	0.55	2	0.5	20	SMB	
SK23BG	30	2	50	0.55	2	0.5	30	SMB	
SK24BG	40	2	50	0.55	2	0.5	40	SMB	
SK25BG	50	2	50	0.7	2	0.5	50	SMB	
SK26BG	60	2	50	0.7	2	0.5	60	SMB	
SK28BG	80	2	50	0.85	2	0.5	80	SMB	
SK210BG	100	2	50	0.85	2	0.5	100	SMB	
SS22BG	20	2	55	0.55	2	0.5	20	SMB	
SS24BG	40	2	55	0.55	2	0.5	40	SMB	
SS26BG	60	2	55	0.7	2	0.5	60	SMB	
SS28BG	80	2	55	0.7	2	0.3	80	SMB	
SS210BG	100	2	45	0.85	2	0.3	100	SMB	
SS212BG	120	2	45	0.85	2	0.3	120	SMB	
SS215BG	150	2	45	0.95	2	0.3	150	SMB	
SS220BG	200	2	45	0.95	2	0.3	200	SMB	
B340BG	40	3	100	0.5	3	0.5	40	SMB	
B360BG	60	3	100	0.7	3	0.5	60	SMB	
SS32BG	20	3	80	0.55	3	0.5	20	SMB	
SS34BG	40	3	80	0.55	3	0.5	40	SMB	
SS36BG	60	3	80	0.7	3	0.5	60	SMB	
SS38BG	80	3	80	0.7	3	0.3	80	SMB	
SS310BG	100	3	80	0.85	3	0.3	100	SMB	
SS312BG	120	3	80	0.85	3	0.3	120	SMB	
SS315BG	150	3	80	0.95	3	0.3	150	SMB	
SS320BG	200	3	80	0.95	3	0.3	200	SMB	
SS52BG	20	5	150	0.55	5	1	20	SMB	
SS54BG	40	5	150	0.55	5	1	40	SMB	
SS56BG	60	5	150	0.7	5	0.3	60	SMB	
SS58BG	80	5	150	0.7	5	0.3	80	SMB	
SS510BG	100	5	150	0.85	5	0.3	100	SMB	
SS512BG	120	5	150	0.85	5	0.3	120	SMB	
SS515BG	150	5	150	0.85	5	0.3	150	SMB	
SS520BG	200	5	150	0.85	5	0.3	200	SMB	
SK32CG	20	3	100	0.5	3	0.5	20	SMC	
SK33CG	30	3	100	0.5	3	0.5	30	SMC	
SK34CG	40	3	100	0.5	3	0.5	40	SMC	
SK35CG	50	3	100	0.7	3	0.5	50	SMC	
SK36CG	60	3	100	0.7	3	0.5	60	SMC	
SK38CG	80	3	100	0.85	3	0.5	80	SMC	
SK310CG	100	3	100	0.85	3	0.5	100	SMC	
SS32CG	20	3	80	0.55	3	0.5	20	SMC	
SS34CG	40	3	80	0.55	3	0.5	40	SMC	
SS36CG	60	3	80	0.7	3	0.5	60	SMC	
SS38CG	80	3	80	0.7	3	0.3	80	SMC	
SS310CG	100	3	80	0.85	3	0.3	100	SMC	
SS312CG	120	3	80	0.85	3	0.3	120	SMC	
SS315CG	150	3	80	0.95	3	0.3	150	SMC	
SS320CG	200	3	80	0.95	3	0.3	200	SMC	
SK52CG	20	5	175	0.45	5	1	20	SMC	
SK54CG	40	5	175	0.55	5	1	40	SMC	
SK56CG	60	5	175	0.7	5	1	60	SMC	
SK58CG	80	5	175	0.7	5	1	80	SMC	
SK510CG	100	5	150	0.85	5	1	100	SMC	
SK512CG	120	5	150	0.85	5	1	120	SMC	
SK515CG	150	5	150	0.85	5	1	150	SMC	

PARAMETER 參數 TYPE 型號	VRRM	I(AV)	IFSM	VF		IR		Package
					IF		VR	
				V	A	mA	V	
SK520CG	200	5	150	0.85	5	1	200	SMC
SS52CG	20	5	175	0.45	5	1	20	SMC
SS54CG	40	5	175	0.55	5	1	40	SMC
SS56CG	60	5	175	0.7	5	1	60	SMC
SS58CG	80	5	175	0.7	5	1	80	SMC
SS510CG	100	5	150	0.85	5	1	100	SMC
SS512CG	120	5	150	0.85	5	1	120	SMC
SS515CG	150	5	150	0.85	5	1	150	SMC
SS520CG	200	5	150	0.85	5	1	200	SMC
SK82CG	20	8	150	0.45	8	1	20	SMC
SK84CG	40	8	150	0.55	8	1	40	SMC
SK86CG	60	8	150	0.7	8	1	60	SMC
SK88CG	80	8	150	0.7	8	1	80	SMC
SK810CG	100	8	150	0.85	8	1	100	SMC
SK812CG	120	8	150	0.85	8	1	120	SMC
SK815CG	150	8	150	0.85	8	1	150	SMC
SK820CG	200	8	150	0.85	8	1	200	SMC
SS82CG	20	8	150	0.45	8	1	20	SMC
SS84CG	40	8	150	0.55	8	1	40	SMC
SS86CG	60	8	150	0.7	8	1	60	SMC
SS88CG	80	8	150	0.7	8	1	80	SMC
SS810CG	100	8	150	0.85	8	1	100	SMC
SS812CG	120	8	150	0.85	8	1	120	SMC
SS815CG	150	8	150	0.85	8	1	150	SMC
SS820CG	200	8	150	0.85	8	1	200	SMC
SS1045CG	45	10	150	0.55	10	0.5	45	SMC
SS1060CG	60	10	150	0.75	10	0.5	60	SMC
SS10100CG	100	10	150	0.9	10	0.5	100	SMC
SKM240-MST	40	2	50	0.5	2	500	40	SOD-123ST
SKM260-MST	60	2	50	0.7	2	500	60	SOD-123ST
BAT46W	100	0.5	30	0.85	0.5	0.2	100	SOD-123FL
B5817WL	20	1	25	0.45	1	1	20	SOD-123FL
B5818WL	30	1	25	0.55	1	1	30	SOD-123FL
B5819WL	40	1	25	0.6	1	1	40	SOD-123FL
CRS01	30	1	25	0.55	1	0.55	30	SOD-123FL
DS12W	20	1	40	0.55	1	0.3	20	SOD-123FL
DS14W	40	1	40	0.55	1	0.3	40	SOD-123FL
DS16W	60	1	40	0.7	1	0.3	60	SOD-123FL
DS18W	80	1	40	0.7	1	0.3	80	SOD-123FL
DS110W	100	1	30	0.85	1	0.2	100	SOD-123FL
DS112W	120	1	30	0.85	1	0.2	120	SOD-123FL
DS115W	150	1	30	0.9	1	0.1	150	SOD-123FL
DS120W	200	1	30	0.9	1	0.1	200	SOD-123FL
MBRX120	20	1	25	0.45	1	1	20	SOD-123FL
MBRX130	30	1	25	0.55	1	1	30	SOD-123FL
MBRX140	40	1	25	0.6	1	1	40	SOD-123FL
SK1020	20	1	25	0.45	1	1	20	SOD-123FL
SK1030	30	1	25	0.55	1	1	30	SOD-123FL
SK1040	40	1	25	0.6	1	1	40	SOD-123FL
SK12WA	20	1	40	0.55	1	0.3	20	SOD-123FL
SK14WA	40	1	40	0.55	1	0.3	40	SOD-123FL
SK16WA	60	1	40	0.7	1	0.3	60	SOD-123FL
SK18WA	80	1	40	0.7	1	0.3	80	SOD-123FL
SK110WA	100	1	25	0.85	1	0.2	100	SOD-123FL
SK112WA	120	1	25	0.85	1	0.2	120	SOD-123FL
SK115WA	150	1	25	0.9	1	0.1	150	SOD-123FL
SK120WA	200	1	25	0.9	1	0.1	200	SOD-123FL
PMEG2010ER	20	1	40	0.55	1	0.2	20	SOD-123FL

PARAMETER TYPE 參數 型號	V _{RRM}	I(AV)	I _{FSM}	V _F		I _R		Package
					I _F		V _R	
				V	A	mA	V	
PMEG3010ER	30	1	40	0.55	1	0.2	30	SOD-123FL
PMEG4010ER	40	1	25	0.6	1	1	40	SOD-123FL
PMEG6010ER	60	1	40	0.7	1	0.3	60	SOD-123FL
CRS08	40	1.5	50	0.55	2	0.5	40	SOD-123FL
PMEG3020ER	30	2	50	0.55	2	0.5	30	SOD-123FL
PMEG4020ER	40	2	50	0.55	2	0.5	40	SOD-123FL
PMEG6020ER	60	2	50	0.7	2	0.5	60	SOD-123FL
DS22W	20	2	50	0.55	3	0.5	20	SOD-123FL
DS24W	40	2	50	0.55	2	0.5	40	SOD-123FL
DS26W	60	2	50	0.7	2	0.5	60	SOD-123FL
DS28W	80	2	50	0.7	2	0.3	80	SOD-123FL
DS210W	100	2	40	0.85	2	0.3	100	SOD-123FL
DS212W	120	2	40	0.85	2	0.3	120	SOD-123FL
DS215W	150	2	40	0.95	2	0.3	150	SOD-123FL
DS220W	200	2	40	0.95	2	0.3	200	SOD-123FL
SK22WA	20	2	40	0.55	2	0.5	20	SOD-123FL
SK24WA	40	2	40	0.55	2	0.5	40	SOD-123FL
SK26WA	60	2	40	0.7	2	0.5	60	SOD-123FL
SK28WA	80	2	40	0.7	2	0.3	80	SOD-123FL
SK210WA	100	2	40	0.85	2	0.3	100	SOD-123FL
SK212WA	120	2	40	0.85	2	0.3	120	SOD-123FL
SK215WA	150	2	40	0.95	2	0.3	150	SOD-123FL
SK220WA	200	2	40	0.95	2	0.3	200	SOD-123FL
MBR230LSF	30	2	50	0.55	0.2	0.5	30	SOD-123FL
DS32W	20	3	80	0.55	3	0.5	20	SOD-123FL
DS34W	40	3	80	0.55	3	0.5	40	SOD-123FL
DS36W	60	3	80	0.7	3	0.3	60	SOD-123FL
DS38W	80	3	80	0.7	3	0.3	80	SOD-123FL
DS310W	100	3	70	0.85	3	0.3	100	SOD-123FL
DS312W	120	3	70	0.85	3	0.3	120	SOD-123FL
DS315W	150	3	70	0.95	3	0.3	150	SOD-123FL
DS320W	200	3	70	0.95	3	0.3	200	SOD-123FL
SK32WA	20	3	80	0.55	3	0.5	20	SOD-123FL
SK34WA	40	3	80	0.55	3	0.5	40	SOD-123FL
SK36WA	60	3	80	0.7	3	0.3	60	SOD-123FL
SK38WA	80	3	80	0.7	3	0.3	80	SOD-123FL
SK310WA	100	3	80	0.85	3	0.3	100	SOD-123FL
SK312WA	120	3	80	0.85	3	0.3	120	SOD-123FL
SK315WA	150	3	80	0.95	3	0.3	150	SOD-123FL
SK320WA	200	3	80	0.95	3	0.3	200	SOD-123FL
PMEG4030ER	40	3	80	0.55	3	0.3	40	SOD-123FL

PARAMETER TYPE 參數 型號	PD	V _{RRM}	I _o	I _F	V _F		I _R		T _{RR}	Package
						I _F		V _R		
					mW	V	mA	mA		
LL60P	20	45	50				50	10	1	SOD-80
LL103A	40			200	0.37	1	5	30	10	SOD-80
BAS85	30	30		200	0.8	100	2	25	5	SOD-80
SD101AW	400	60		15	0.41	1	0.2	50	1	SOD-123
SD101BW	400	50		15	0.4	1	0.2	40	1	SOD-123
SD101CW	400	40		15	0.39	1	0.2	30	1	SOD-123
BAT275W		100		150	0.45	10	5	75		SOD-123
BAT54T	200	30	100	200	0.4	10	2	25	5	SOD-123
BAT42W	200	30		200	0.65	50	0.5	25	5	SOD-123
BAT43W	200	30		200	0.45	15	0.5	25	5	SOD-123

PARAMETER TYPE 型號	PD	V _{RRM}	I _o	I _F	V _F		I _R		T _{RR}	Package
						I _F		V _R		
					mW	V	V	mA	V	
B0520W	400	20		350	0.37	20	5	10	10	SOD-123
B0530W	400	30		350	0.37	20	5	20	10	SOD-123
B0540W	400	40		350	0.37	20	5	30	10	SOD-123
SD103AW	400	40		350	0.6	200	5	30	10	SOD-123
SD103BW	400	30		350	0.6	200	5	20	10	SOD-123
SD103CW	400	20		350	0.6	200	5	10	10	SOD-123
FM102H	600	20	1000	625	0.45	1000	1000	20		SOD-123
RSX101VA-30	250	30	1000		0.55	1000	1000	30		SOD-123
MBR130		30		1000	0.45	700	60	30		SOD-123
MBR120ESF	250	20	1000		0.6	1000	1000	20		SOD-123
MBR120LSF	250	20	1000		0.6	1000	1000	20		SOD-123
MBR140SF	250	40	1000		0.6	1000	1000	20		SOD-123
MBR140LSF	250	40	1000		0.6	1000	1000	20		SOD-123
RB160M-30	250		1000		0.6	1000	1000	30		SOD-123
RB160M-40	250		1000		0.6	1000	1000	40		SOD-123
RB161M-20	250	20	1000		0.6	1000	1000	20		SOD-123
SD101AWS	200	60		15	1	15	0.2	50	1	SOD-323
SD101BWS	200	50		15	0.95	15	0.2	40	1	SOD-323
SD101CWS	200	40		15	0.9	15	0.2	30	1	SOD-323
RB5712		40	30		0.37	1	0.5	30		SOD-323
BAS70WS	200	70		70	1	15	0.1	50	5	SOD-323
SD107WS	250	30		100	0.8	100	1	25		SOD-323
KDR367		45	100		0.6	100	5	40		SOD-323
MA728	400	30		150	0.8	200	5	30	10	SOD-323
BAT46WS	200	100		150	0.45	10	2	75		SOD-323
BAS40WS	200	40		200	1	40	0.2	30	5	SOD-323
BAT42WS	200	30	100	200	0.4	10	0.5	25	5	SOD-323
BAT43WS	200	30	100	200	0.45	15	0.5	25	5	SOD-323
BAT54WS	200	30	100	200	1	100	2	25	5	SOD-323
BAT54H	200	30		300	0.6	200	5	30	10	SOD-323
MA729	200	30		300	0.6	200	5	30	10	SOD-323
B0520WS	400	20		350	0.6	200	5	10	10	SOD-323
B0530WS	400	30		350	0.6	200	5	20	10	SOD-323
B0540WS	400	40		350	0.6	200	5	30	10	SOD-323
SD103AWS	200	40		350	0.6	200	5	30	10	SOD-323
SD103BWS	200	30		350	0.6	200	5	20	10	SOD-323
SD103CWS	200	20		350	0.6	200	5	10	10	SOD-323
BAT760		30	500		0.47	500	100	20		SOD-323
RB160VA-40	250	40	1000		0.45	1000	1000	20		SOD-323
RB161VA-20	250	20	1000		0.45	1000	1000	20		SOD-323
RB751S-40	150	40	100	30	0.37	1	0.5	30		SOD-523
1SS387	150	80	100	100	1.2	100	0.5	80		SOD-523
1SS388	150	40		100	0.6	50	5	10		SOD-523
RB520S-40	150	40	200		0.55	100	10	40		SOD-523
RB520S-30	200	30	200	200	0.6	200	1	10		SOD-523
RB521S-30		30	200	200	0.5	200	30	10		SOD-523
BAT54XV2		30	200		0.5	200	30	10		SOD-523
BAT64-02W	200	40		250	0.6	200	5	30	10	SOD-523
SDM20U40	400	40		250	0.6	200	5	30	10	SOD-523
HSC226	400	40		350	0.6	200	5	30	10	SOD-523
SD103AX	400	40		350	0.6	200	5	30	10	SOD-523
SD103BX	400	30		350	0.6	200	5	20	10	SOD-523
SD103CX	400	20		350	0.6	200	5	10	10	SOD-523
RB520G-30		30	100		0.45	10	0.5	10		SOD-723
SBK1040E		40		1000	0.49	1000	100	40		SOD-882

TYPE 型號	PARAMETER 參數	VRRM	I(AV)	IFSM	VF		IR		Package
						IF		VR	
					V	A	mA	V	
MBRD340	40	3	80	0.6	3	0.5	40	TO-252	
MBRD345	45	3	80	0.6	3	0.5	45	TO-252	
MBRD360	60	3	80	0.7	3	0.5	60	TO-252	
MBRD3100	100	3	80	0.85	3	0.5	100	TO-252	
MBRD3150	150	3	80	0.9	3	0.5	150	TO-252	
MBRD3200	200	3	80	0.92	3	0.5	200	TO-252	
MBRD540	40	5	150	0.6	5	0.5	40	TO-252	
MBRD545	45	5	150	0.6	5	0.5	45	TO-252	
MBRD560	60	5	150	0.7	5	0.5	60	TO-252	
MBRD5100	100	5	150	0.85	5	0.5	100	TO-252	
MBRD5150	150	5	150	0.9	5	0.5	150	TO-252	
MBRD5200	200	5	150	0.92	5	0.5	200	TO-252	
MBRD840	40	8	150	0.6	8	0.5	40	TO-252	
MBRD845	45	8	150	0.6	8	0.5	45	TO-252	
MBRD860	60	8	150	0.7	8	0.5	60	TO-252	
MBRD8100	100	8	150	0.85	8	0.5	100	TO-252	
MBRD8150	150	8	150	0.9	8	0.5	150	TO-252	
MBRD8200	200	8	150	0.92	8	0.5	200	TO-252	
MBRD1040	40	10	150	0.6	10	0.5	40	TO-252	
MBRD1045	45	10	150	0.6	10	0.5	45	TO-252	
MBRD1060	60	10	150	0.7	10	0.5	60	TO-252	
MBRD10100	100	10	150	0.85	10	0.5	100	TO-252	
MBRD10150	150	10	150	0.9	10	0.5	150	TO-252	
MBRD10200	200	10	150	0.92	10	0.5	200	TO-252	
MBRD2040	40	20	120	0.6	10	0.1	40	TO-252	
MBRD2045	45	20	120	0.6	10	0.1	45	TO-252	
MBRD2060	60	20	120	0.7	10	0.1	60	TO-252	
MBRD20100	100	20	120	0.85	10	0.1	100	TO-252	
MBRD20150	150	20	120	0.9	10	0.1	150	TO-252	
MBRD20200	200	20	120	0.92	10	0.1	200	TO-252	

TYPE 型號	PARAMETER 參數	PD	PIN ARRAY	VRRM	IF	VF		IR		TRR	Package
							IF		VR		
						mW	V	V	mA		
BAS70	200	壹陽三陰	70	70	1	15	0.1	50	5	SOT-23	
BAS70-04	200	串聯壹陽	70	70	1	15	0.1	50	5	SOT-23	
BAS70-05	200	共陰三陰	70	70	1	15	0.1	50	5	SOT-23	
BAS70-06	200	共陽三陽	70	70	1	15	0.1	50	5	SOT-23	
CMPSH-3	350	壹陽三陰	30	100	1	100	0.5	25	5	SOT-23	
CMPSH-3A	350	共陽三陽	30	100	1	100	0.5	25	5	SOT-23	
CMPSH-3C	350	共陽三陰	30	100	1	100	0.5	25	5	SOT-23	
CMPSH-3S	350	串聯壹陽	30	100	1	100	0.5	25	5	SOT-23	
BAS40	350	壹陽三陰	40	200	1	40	0.2	30	5	SOT-23	
BAS40-04	350	串聯壹陽	40	200	1	40	0.2	30	5	SOT-23	
BAS40-05	350	共陰三陰	40	200	1	40	0.2	30	5	SOT-23	
BAS40-06	350	共陽三陽	40	200	1	40	0.2	30	5	SOT-23	
BAT54	200	壹陽三陰	30	200	1	100	2	25	5	SOT-23	
BAT54A	200	共陽三陽	30	200	1	100	2	25	5	SOT-23	
BAT54C	200	共陰三陰	30	200	1	100	2	25	5	SOT-23	
BAT54S	200	串聯壹陽	30	200	1	100	2	25	5	SOT-23	
RB717F		共陽三陽	40	30	0.37	1	1	10		SOT-323	
BAS40W	200	壹陽三陰	40	200	1	40	0.2	30	5	SOT-323	
BAS40W-04	200	串聯壹陽	40	200	1	40	0.2	30	5	SOT-323	
BAS40W-05	200	共陽三陰	40	200	1	40	0.2	30	5	SOT-323	
BAS40W-06	200	共陽三陽	40	200	1	40	0.2	30	5	SOT-323	

PARAMETER TYPE 型號	PD 參數	PIN ARRAY	V _{RRM}	I _F	V _F		I _R		T _{RR}	Package		
					mW	V	V	mA			μA	V
BAT54W	200	壹陽三陰	30	200	1	100	2	25	5	SOT-323		
BAT54AW	200	共陽三陽	30	200	1	100	2	25	5	SOT-323		
BAT54CW	200	共陽三陰	30	200	1	100	2	25	5	SOT-323		
BAT54SW	200	串聯壹陽	30	200	1	100	2	25	5	SOT-323		

PARAMETER TYPE 型號	PIN ARRAY	V _{RRM}	I _F	I _{FSM}	V _F		I _R		Package		
					V	A	V	mA		mA	V
MBR1040CT	共陰	40	10	100	0.7	10	0.1	40	TO-220		
MBR1045CT	共陰	45	10	100	0.7	10	0.1	45	TO-220		
MBR1060CT	共陰	60	10	100	0.75	10	0.1	60	TO-220		
MBR10100CT	共陰	100	10	100	0.85	10	0.05	100	TO-220		
MBR10150CT	共陰	150	10	100	0.9	10	0.05	150	TO-220		
MBR10200CT	共陰	200	10	100	0.92	10	0.05	200	TO-220		
MBR2040CT	共陰	40	20	150	0.7	20	0.1	40	TO-220		
MBR2045CT	共陰	45	20	150	0.7	20	0.1	45	TO-220		
MBR2060CT	共陰	60	20	150	0.75	20	0.1	60	TO-220		
MBR20100CT	共陰	100	20	150	0.85	20	0.05	100	TO-220		
MBR20150CT	共陰	150	20	150	0.9	20	0.05	150	TO-220		
MBR20200CT	共陰	200	20	150	0.92	20	0.05	200	TO-220		
MBR20L300CT	共陰	300	20	150	0.98	20	0.005	300	TO-220		
MBR3040CT	共陰	40	30	200	0.7	30	0.1	40	TO-220		
MBR3045CT	共陰	45	30	200	0.7	30	0.1	45	TO-220		
MBR3060CT	共陰	60	30	200	0.75	30	0.1	60	TO-220		
MBR30100CT	共陰	100	30	200	0.85	30	0.05	100	TO-220		
MBR30150CT	共陰	150	30	200	0.9	30	0.05	150	TO-220		
MBR30200CT	共陰	200	30	200	0.92	30	0.05	200	TO-220		
MBR4040CT	共陰	40	40	250	0.7	40	0.1	40	TO-220		
MBR4045CT	共陰	45	40	250	0.7	40	0.1	45	TO-220		
MBR4060CT	共陰	60	40	250	0.75	40	0.1	60	TO-220		
MBR40100CT	共陰	100	40	250	0.85	40	0.05	100	TO-220		
MBR40150CT	共陰	150	40	250	0.9	40	0.05	150	TO-220		
MBR40200CT	共陰	200	40	250	0.92	40	0.05	200	TO-220		
MBR1040CTF	共陰	40	10	100	0.7	10	0.1	40	TO-220F		
MBR1045CTF	共陰	45	10	100	0.7	10	0.1	45	TO-220F		
MBR1060CTF	共陰	60	10	100	0.75	10	0.1	60	TO-220F		
MBR10100CTF	共陰	100	10	100	0.85	10	0.05	100	TO-220F		
MBR10150CTF	共陰	150	10	100	0.9	10	0.05	150	TO-220F		
MBR10200CTF	共陰	200	10	100	0.92	10	0.05	200	TO-220F		
MBR2040CTF	共陰	40	20	150	0.7	20	0.1	40	TO-220F		
MBR2045CTF	共陰	45	20	150	0.7	20	0.1	45	TO-220F		
MBR2060CTF	共陰	60	20	150	0.75	20	0.1	60	TO-220F		
MBR20100CTF	共陰	100	20	150	0.85	20	0.05	100	TO-220F		
MBR20150CTF	共陰	150	20	150	0.9	20	0.05	150	TO-220F		
MBR20200CTF	共陰	200	20	150	0.92	20	0.05	200	TO-220F		
MBRF20150CTATF	共陽	150	20	150	0.92	20	0.02	150	TO-220F		
MBR20L300CTF	共陰	300	20	150	0.98	20	0.005	300	TO-220F		
MBR3040CTF	共陰	40	30	200	0.7	30	0.1	40	TO-220F		
MBR3045CTF	共陰	45	30	200	0.7	30	0.1	45	TO-220F		
MBR3060CTF	共陰	60	30	200	0.75	30	0.1	60	TO-220F		
MBR30100CTF	共陰	100	30	200	0.85	30	0.05	100	TO-220F		
MBR30150CTF	共陰	150	30	200	0.9	30	0.05	150	TO-220F		
MBR30200CTF	共陰	200	30	200	0.92	30	0.05	200	TO-220F		
MBR4040CTF	共陰	40	40	250	0.7	40	0.1	40	TO-220F		
MBR4045CTF	共陰	45	40	250	0.7	40	0.1	45	TO-220F		

TYPE 型號	PARAMETER 參數	PIN ARRAY	VRRM	IF	IFSM	VF		IR		Package
							IF		VR	
						V	mA	mA	V	
MBR4060CTF	共陰	60	40	250	0.75	40	0.1	60	TO-220F	
MBR40100CTF	共陰	100	40	250	0.85	40	0.05	100	TO-220F	
MBR40150CTF	共陰	150	40	250	0.9	40	0.5	150	TO-220F	
MBR40200CTF	共陰	200	40	250	0.92	40	0.05	200	TO-220F	

GENERAL RECTIFIER DIODES

普通整流二極管

TYPE 型號	PARAMETER 參數	VRRM	I(AV)	IFSM	VF		IR		Package
						IF		VR	
					V	A	μA	V	
1N4001F	50	1	30	1.1	1	5	50	SMAF	
1N4002F	100	1	30	1.1	1	5	100	SMAF	
1N4003F	200	1	30	1.1	1	5	200	SMAF	
1N4004F	400	1	30	1.1	1	5	400	SMAF	
1N4005F	600	1	30	1.1	1	5	600	SMAF	
1N4006F	800	1	30	1.1	1	5	800	SMAF	
1N4007F	1000	1	30	1.1	1	5	1000	SMAF	
S1AF	50	1	25	1.1	1	5	50	SMAF	
S1BF	100	1	25	1.1	1	5	100	SMAF	
S1DF	200	1	25	1.1	1	5	200	SMAF	
S1GF	400	1	25	1.1	1	5	400	SMAF	
S1JF	600	1	25	1.1	1	5	600	SMAF	
S1KF	800	1	25	1.1	1	5	800	SMAF	
S1MF	1000	1	25	1.1	1	5	1000	SMAF	
S2AF	50	2	60	1.1	2	5	50	SMAF	
S2BF	100	2	60	1.1	2	5	100	SMAF	
S2DF	200	2	60	1.1	2	5	200	SMAF	
S2GF	400	2	60	1.1	2	5	400	SMAF	
S2JF	600	2	60	1.1	2	5	600	SMAF	
S2KF	800	2	60	1.1	2	5	800	SMAF	
S2MF	1000	2	60	1.1	2	5	1000	SMAF	
S3AF	50	3	100	1.2	3	5	50	SMAF	
S3BF	100	3	100	1.2	3	5	100	SMAF	
S3DF	200	3	100	1.2	3	5	200	SMAF	
S3GF	400	3	100	1.2	3	5	400	SMAF	
S3JF	600	3	100	1.2	3	5	600	SMAF	
S3KF	800	3	100	1.2	3	5	800	SMAF	
S3MF	1000	3	100	1.2	3	5	1000	SMAF	
S2ABF	50	2	60	1.1	2	5	50	SMBF	
S2BBF	100	2	60	1.1	2	5	100	SMBF	
S2DBF	200	2	60	1.1	2	5	200	SMBF	
S2GBF	400	2	60	1.1	2	5	400	SMBF	
S2JBF	600	2	60	1.1	2	5	600	SMBF	
S2KBF	800	2	60	1.1	2	5	800	SMBF	
S2MBF	1000	2	60	1.1	2	5	1000	SMBF	
1SR154-400	400	1	30	1.1	1	10	400	SMA	
1SR154-600	600	1	30	1.1	1	10	600	SMA	

TYPE 型號	PARAMETER 參數	VRRM	I(AV)	IFSM	VF		IR		Package
						IF		VR	
					V	A	μA	V	
1N4001G	50	1	30	1.1	1	5	50	SMA	
1N4002G	100	1	30	1.1	1	5	100	SMA	
1N4004G	400	1	30	1.1	1	5	400	SMA	
1N4007G	1000	1	30	1.1	1	5	1000	SMA	
GS1AG	50	1	30	1.1	1	5	50	SMA	
GS1BG	100	1	30	1.1	1	5	100	SMA	
GS1DG	200	1	30	1.1	1	5	200	SMA	
GS1GG	400	1	30	1.1	1	5	400	SMA	
GS1JG	600	1	30	1.1	1	5	600	SMA	
GS1KG	800	1	30	1.1	1	5	800	SMA	
GS1MG	1000	1	30	1.1	1	5	1000	SMA	
S1AG	50	1	35	1.1	1	5	50	SMA	
S1BG	100	1	35	1.1	1	5	100	SMA	
S1DG	200	1	35	1.1	1	5	200	SMA	
S1GG	400	1	35	1.1	1	5	400	SMA	
S1JG	600	1	35	1.1	1	5	600	SMA	
S1KG	800	1	35	1.1	1	5	800	SMA	
S1MG	1000	1	35	1.1	1	5	1000	SMA	
S2AG	50	2	70	1.1	2	5	50	SMA	
S2BG	100	2	70	1.1	2	5	100	SMA	
S2DG	200	2	70	1.1	2	5	200	SMA	
S2GG	400	2	70	1.1	2	5	400	SMA	
S2JG	600	2	70	1.1	2	5	600	SMA	
S2KG	800	2	70	1.1	2	5	800	SMA	
S2MG	1000	2	70	1.1	2	5	1000	SMA	
S2ABG	50	2	60	1.1	2	5	50	SMB	
S2BBG	100	2	60	1.1	2	5	100	SMB	
S2DBG	200	2	60	1.1	2	5	200	SMB	
S2GBG	400	2	60	1.1	2	5	400	SMB	
S2JBG	600	2	60	1.1	2	5	600	SMB	
S2KBG	800	2	60	1.1	2	5	800	SMB	
S2MBG	1000	2	60	1.1	2	5	1000	SMB	
S3ABG	50	3	90	1.1	3	5	50	SMB	
S3BBG	100	3	90	1.1	3	5	100	SMB	
S3DBG	200	3	90	1.1	3	5	200	SMB	
S3GBG	400	3	90	1.1	3	5	400	SMB	
S3JBG	600	3	90	1.1	3	5	600	SMB	
S3KBG	800	3	90	1.1	3	5	800	SMB	
S3MBG	1000	3	90	1.1	3	5	1000	SMB	
S3ACG	50	3	90	1	3	5	50	SMC	
S3BCG	100	3	90	1	3	5	100	SMC	
S3DCG	200	3	90	1	3	5	200	SMC	
S3GCG	400	3	90	1	3	5	400	SMC	
S3JCG	600	3	90	1	3	5	600	SMC	
S3KCG	800	3	90	1	3	5	800	SMC	
S3MCG	1000	3	90	1	3	5	1000	SMC	
S5ACG	50	5	120	1	5	5	50	SMC	
S5BCG	100	5	120	1	5	5	100	SMC	
S5DCG	200	5	120	1	5	5	200	SMC	
S5GCG	400	5	120	1	5	5	400	SMC	
S5JCG	600	5	120	1	5	5	600	SMC	
S5KCG	800	5	120	1	5	5	800	SMC	
S5MCG	1000	5	120	1	5	5	1000	SMC	
S6ACG	50	6	150	1.15	6	5	50	SMC	
S6BCG	100	6	150	1.15	6	5	100	SMC	
S6DCG	200	6	150	1.15	6	5	200	SMC	
S6GCG	400	6	150	1.15	6	5	400	SMC	

PARAMETER TYPE 參數 型號	VRRM	I(AV)	IFSM	VF		IR		Package
					IF		VR	
				V	A	μA	V	
S6JCG	600	6	150	1.15	6	5	600	SMC
S6KCG	800	6	150	1.15	6	5	800	SMC
S6MCG	1000	6	150	1.15	6	5	1000	SMC
S10ACG	50	10	200	1	10	5	50	SMC
S10BCG	100	10	200	1	10	5	100	SMC
S10DCG	200	10	200	1	10	5	200	SMC
S10GCG	400	10	200	1	10	5	400	SMC
S10JCG	600	10	200	1	10	5	600	SMC
S10KCG	800	10	200	1	10	5	800	SMC
S10MCG	1000	10	200	1	10	5	1000	SMC
SK4001WA	50	1	25	1.1	1	5	50	SOD-123FL
SK4002WA	100	1	25	1.1	1	5	100	SOD-123FL
SK4003WA	200	1	25	1.1	1	5	200	SOD-123FL
SK4004WA	400	1	25	1.1	1	5	400	SOD-123FL
SK4005WA	600	1	25	1.1	1	5	600	SOD-123FL
SK4006WA	800	1	25	1.1	1	5	800	SOD-123FL
SK4007WA	1000	1	25	1.1	1	5	1000	SOD-123FL
SKR1AWA	50	1	30	1.1	1	5	50	SOD-123FL
SKR1BWA	100	1	30	1.1	1	5	100	SOD-123FL
SKR1DWA	200	1	30	1.1	1	5	200	SOD-123FL
SKR1GWA	400	1	30	1.1	1	5	400	SOD-123FL
SKR1JWA	600	1	30	1.1	1	5	600	SOD-123FL
SKR1KWA	800	1	30	1.1	1	5	800	SOD-123FL
SKR1MWA	1000	1	30	1.1	1	5	1000	SOD-123FL
DSR1AW	50	1	30	1.1	1	5	50	SOD-123FL
DSR1BW	100	1	30	1.1	1	5	100	SOD-123FL
DSR1DW	200	1	30	1.1	1	5	200	SOD-123FL
DSR1GW	400	1	30	1.1	1	5	400	SOD-123FL
DSR1JW	600	1	30	1.1	1	5	600	SOD-123FL
DSR1KW	800	1	30	1.1	1	5	800	SOD-123FL
DSR1MW	1000	1	30	1.1	1	5	1000	SOD-123FL
S2AW	50	2	50	1.1	2	5	50	SOD-123FL
S2BW	100	2	50	1.1	2	5	100	SOD-123FL
S2DW	200	2	50	1.1	2	5	200	SOD-123FL
S2GW	400	2	50	1.1	2	5	400	SOD-123FL
S2JW	600	2	50	1.1	2	5	600	SOD-123FL
S2KW	800	2	50	1.1	2	5	800	SOD-123FL
S2MW	1000	2	50	1.1	2	5	1000	SOD-123FL

PARAMETER TYPE 參數 型號	VRRM	I(AV)	IFSM	VF		IR		TRR	Package
					IF		VR		
				V	A	μA	V		
SGP1A	50	1	15	1.1	1	5	50	1.8	SOD-323
SGP2A	100	1	15	1.1	1	5	100	1.8	SOD-323
SGP3A	200	1	15	1.1	1	5	200	1.8	SOD-323
SGP4A	400	1	15	1.1	1	5	400	1.8	SOD-323
SGP5A	600	1	15	1.1	1	5	600	1.8	SOD-323
SGP6A	800	1	15	1.1	1	5	800	1.8	SOD-323
SGP7A	1000	1	15	1.1	1	5	1000	1.8	SOD-323

SMALL SIGNAL RECTIFIER DIODES

小信號整流二極管

PARAMETER TYPE 參數 型號	I(AV)	IFSM	VF		IR		Package Outline
			V	IF	μA	VR	
	V	A	V	A	μA	V	
2CZ4007	1	15	1.1	1	5	1000	SOD-123
S08JWS	1	7.5	1.1	1	5	600	SOD-323

FAST RECOVERY RECTIFIERS

快恢復整流管

PARAMETER TYPE 參數 型號	VRRM	I(AV)	IFSM	VF		IR		TRR	Package
				V	IF	μA	VR		
	V	A	A	V	A	μA	V	NS	
RS1AF	50	1	30	1.3	1	5	50	150	SMAF
RS1BF	100	1	30	1.3	1	5	100	150	SMAF
RS1DF	200	1	30	1.3	1	5	200	150	SMAF
RS1GF	400	1	30	1.3	1	5	400	150	SMAF
RS1JF	600	1	30	1.3	1	5	600	250	SMAF
RS1KF	800	1	30	1.3	1	5	800	500	SMAF
RS1MF	1000	1	30	1.3	1	5	1000	500	SMAF
RS2AF	50	2	50	1.3	2	5	50	150	SMAF
RS2BF	100	2	50	1.3	2	5	100	150	SMAF
RS2DF	200	2	50	1.3	2	5	200	150	SMAF
RS2GF	400	2	50	1.3	2	5	400	150	SMAF
RS2JF	600	2	50	1.3	2	5	600	250	SMAF
RS2KF	800	2	50	1.3	2	5	800	500	SMAF
RS2MF	1000	2	50	1.3	2	5	1000	500	SMAF
RS3AF	50	3	100	1.3	3	5	50	150	SMAF
RS3BF	100	3	100	1.3	3	5	100	150	SMAF
RS3DF	200	3	100	1.3	3	5	200	150	SMAF
RS3GF	400	3	100	1.3	3	5	400	150	SMAF
RS3JF	600	3	100	1.3	3	5	600	250	SMAF
RS3KF	800	3	100	1.3	3	5	800	250	SMAF
RS3MF	1000	3	100	1.3	3	5	1000	250	SMAF
RS2ABF	50	2	50	1.3	2	5	50	150	SMBF
RS2BBF	100	2	50	1.3	2	5	100	150	SMBF
RS2DBF	200	2	50	1.3	2	5	200	150	SMBF
RS2GBF	400	2	50	1.3	2	5	400	150	SMBF
RS2JBF	600	2	50	1.3	2	5	600	250	SMBF
RS2KBF	800	2	50	1.3	2	5	800	500	SMBF
RS2MBF	1000	2	50	1.3	2	5	1000	500	SMBF
RS3ABF	50	3	100	1.3	3	5	50	150	SMBF
RS3BBF	100	3	100	1.3	3	5	100	150	SMBF
RS3DBF	200	3	100	1.3	3	5	200	150	SMBF
RS3GBF	400	3	100	1.3	3	5	400	150	SMBF
RS3JBF	600	3	100	1.3	3	5	600	250	SMBF
RS3KBF	800	3	100	1.3	3	5	800	250	SMBF

TYPE 型號	PARAMETER 參數	VRRM	I(AV)	IFSM	VF		IR		T _{RR}	Package		
	V				A	V	A	μA			V _R	NS
RS3MBF		1000	3	100	1.3	3	5	1000	250	SMBF		
RS5ABF		50	5	125	1.3	3	5	50	150	SMBF		
RS5BBF		100	5	125	1.3	3	5	100	150	SMBF		
RS5DBF		200	5	125	1.3	3	5	200	150	SMBF		
RS5GBF		400	5	125	1.3	3	5	400	150	SMBF		
RS5JBF		600	5	125	1.3	3	5	600	250	SMBF		
RS5KBF		800	5	125	1.3	3	5	800	250	SMBF		
RS5MBF		1000	5	125	1.3	3	5	1000	250	SMBF		
RS1AG		50	1	30	1.3	1	5	50	150	SMA		
RS1BG		100	1	30	1.3	1	5	100	150	SMA		
RS1DG		200	1	30	1.3	1	5	200	150	SMA		
RS1GG		400	1	30	1.3	1	5	400	150	SMA		
RS1JG		600	1	30	1.3	1	5	600	250	SMA		
RS1KG		800	1	30	1.3	1	5	800	500	SMA		
RS1MG		1000	1	30	1.3	1	5	1000	500	SMA		
RS2AG		50	2	50	1.3	2	5	50	150	SMA		
RS2BG		100	2	50	1.3	2	5	100	150	SMA		
RS2DG		200	2	50	1.3	2	5	200	150	SMA		
RS2GG		400	2	50	1.3	2	5	400	150	SMA		
RS2JG		600	2	50	1.3	2	5	600	250	SMA		
RS2KG		800	2	50	1.3	2	5	800	500	SMA		
RS2MG		1000	2	50	1.3	2	5	1000	500	SMA		
RS2ABG		50	2	60	1.3	2	5	50	150	SMB		
RS2BBG		100	2	60	1.3	2	5	100	150	SMB		
RS2DBG		200	2	60	1.3	2	5	200	150	SMB		
RS2GBG		400	2	60	1.3	2	5	400	150	SMB		
RS2JBG		600	2	60	1.3	2	5	600	250	SMB		
RS2KBG		800	2	60	1.3	2	5	800	500	SMB		
RS2MBG		1000	2	60	1.3	2	5	1000	500	SMB		
RS3ABG		50	3	90	1.3	3	5	50	150	SMB		
RS3BBG		100	3	90	1.3	3	5	100	150	SMB		
RS3DBG		200	3	90	1.3	3	5	200	150	SMB		
RS3GBG		400	3	90	1.3	3	5	400	150	SMB		
RS3JBG		600	3	90	1.3	3	5	600	250	SMB		
RS3KBG		800	3	90	1.3	3	5	800	500	SMB		
RS3MBG		1000	3	90	1.3	3	5	1000	500	SMB		
RS5ABG		50	5	120	1.3	5	10	50	150	SMB		
RS5BBG		100	5	120	1.3	5	10	100	150	SMB		
RS5DBG		200	5	120	1.3	5	10	200	150	SMB		
RS5GBG		400	5	120	1.3	5	10	400	150	SMB		
RS5JBG		600	5	120	1.3	5	10	600	250	SMB		
RS5KBG		800	5	120	1.3	5	10	800	500	SMB		
RS5MBG		1000	5	120	1.3	5	10	1000	500	SMB		
RS3ACG		50	3	90	1.3	3	5	50	150	SMC		
RS3BCG		100	3	90	1.3	3	5	100	150	SMC		
RS3DCG		200	3	90	1.3	3	5	200	150	SMC		
RS3GCG		400	3	90	1.3	3	5	400	150	SMC		
RS3JCG		600	3	90	1.3	3	5	600	250	SMC		
RS3KCG		800	3	90	1.3	3	5	800	500	SMC		
RS3MCG		1000	3	90	1.3	3	5	1000	500	SMC		
RS5ACG		50	5	120	1.3	3	5	50	150	SMC		
RS5BCG		100	5	120	1.3	3	5	100	150	SMC		
RS5DCG		200	5	120	1.3	3	5	200	150	SMC		
RS5GCG		400	5	120	1.3	3	5	400	150	SMC		
RS5JCG		600	5	120	1.3	3	5	600	250	SMC		
RS5KCG		800	5	120	1.3	3	5	800	500	SMC		
RS5MCG		1000	5	120	1.3	3	5	1000	500	SMC		

TYPE 型號	PARAMETER 參數	VRRM	I(AV)	IFSM	VF		IR		TRR	Package
					V	A	μA	VR		
FS1AW	50	1	30	1.3	1	5	50	150	SOD-123FL	
FS1BW	100	1	30	1.3	1	5	100	150	SOD-123FL	
FS1DW	200	1	30	1.3	1	5	200	150	SOD-123FL	
FS1GW	400	1	30	1.3	1	5	400	150	SOD-123FL	
FS1JW	600	1	30	1.3	1	5	600	250	SOD-123FL	
FS1KW	800	1	30	1.3	1	5	800	500	SOD-123FL	
FS1MW	1000	1	30	1.3	1	5	1000	500	SOD-123FL	
FR101W	50	1	25	1.3	1	5	50	150	SOD-123FL	
FR102W	100	1	25	1.3	1	5	100	150	SOD-123FL	
FR103W	200	1	25	1.3	1	5	200	150	SOD-123FL	
FR104W	400	1	25	1.3	1	5	400	150	SOD-123FL	
FR105W	600	1	25	1.3	1	5	600	250	SOD-123FL	
FR106W	800	1	25	1.3	1	5	800	500	SOD-123FL	
FR107W	1000	1	25	1.3	1	5	1000	500	SOD-123FL	
RS2AW	50	2	50	1.3	2	5	50	150	SOD-123FL	
RS2BW	100	2	50	1.3	2	5	100	150	SOD-123FL	
RS2DW	200	2	50	1.3	2	5	200	150	SOD-123FL	
RS2GW	400	2	50	1.3	2	5	400	150	SOD-123FL	
RS2JW	600	2	50	1.3	2	5	600	250	SOD-123FL	
RS2KW	800	2	50	1.3	2	5	800	500	SOD-123FL	
RS2MW	1000	2	50	1.3	2	5	1000	500	SOD-123FL	

HIGH EFFICIENCY RECTIFIERS

高效整流管

TYPE 型號	PARAMETER 參數	VRRM	I(AV)	IFSM	VF		IR		TRR	Package
					V	A	μA	VR		
US1AF	50	1	25	1	1	5	50	50	SMAF	
US1BF	100	1	25	1	1	5	100	50	SMAF	
US1DF	200	1	25	1	1	5	200	50	SMAF	
US1GF	400	1	25	1.4	1	5	400	50	SMAF	
US1JF	600	1	25	1.7	1	5	600	75	SMAF	
US1KF	800	1	25	1.7	1	5	800	75	SMAF	
US1MF	1000	1	25	1.7	1	5	1000	75	SMAF	
US2AF	50	2	50	1	1	5	50	50	SMAF	
US2BF	100	2	50	1	1	5	100	50	SMAF	
US2DF	200	2	50	1	1	5	200	50	SMAF	
US2GF	400	2	50	1.4	1	5	400	50	SMAF	
US2JF	600	2	50	1.7	1	5	600	75	SMAF	
US2KF	800	2	50	1.7	1	5	800	75	SMAF	
US2MF	1000	2	50	1.7	1	5	1000	75	SMAF	
US3AF	50	3	100	1	3	5	50	75	SMAF	
US3BF	100	3	100	1	3	5	100	75	SMAF	
US3DF	200	3	100	1	3	5	200	75	SMAF	
US3GF	400	3	100	1.4	3	5	400	75	SMAF	
US3JF	600	3	100	1.7	3	5	600	75	SMAF	
US3KF	800	3	100	1.7	3	5	800	75	SMAF	
US3MF	1000	3	100	1.7	3	5	1000	75	SMAF	

TYPE 型號	PARAMETER 參數	VRRM	I(AV)	IFSM	VF		IR		T _{RR}	Package		
	V				A	V	IF	μA			VR	NS
							A				V	
US2ABF	50	2	55	1	2	5	50	50	SMBF			
US2BBF	100	2	55	1	2	5	100	50	SMBF			
US2DBF	200	2	55	1	2	5	200	50	SMBF			
US2GBF	400	2	55	1.3	2	5	400	50	SMBF			
US2JBF	600	2	50	1.6	2	5	600	75	SMBF			
US2KBF	800	2	50	1.6	2	5	800	75	SMBF			
US2MBF	1000	2	50	1.6	2	5	1000	75	SMBF			
US3ABF	50	3	100	1	3	5	50	50	SMBF			
US3BBF	100	3	100	1	3	5	100	50	SMBF			
US3DBF	200	3	100	1	3	5	200	50	SMBF			
US3GBF	400	3	100	1.3	3	5	400	50	SMBF			
US3JBF	600	3	100	1.6	3	5	600	75	SMBF			
US3KBF	800	3	100	1.6	3	5	800	75	SMBF			
US3MBF	1000	3	100	1.6	3	5	1000	75	SMBF			
US5ABF	50	5	125	1	5	10	50	50	SMBF			
US5BBF	100	5	125	1	5	10	100	50	SMBF			
US5DBF	200	5	125	1	5	10	200	50	SMBF			
US5GBF	400	5	125	1.3	5	10	400	50	SMBF			
US5JBF	600	5	125	1.68	5	10	600	75	SMBF			
US5KBF	800	5	125	1.68	5	10	800	75	SMBF			
US5MBF	1000	5	125	1.68	5	10	1000	75	SMBF			
US1AG	50	1	30	1	1	5	50	50	SMA			
US1GG	400	1	30	1.3	1	5	400	50	SMA			
US1JG	600	1	30	1.7	1	5	600	75	SMA			
US1KG	800	1	30	1.7	1	5	800	75	SMA			
US1MG	1000	1	30	1.7	1	5	1000	75	SMA			
US2AG	50	2	70	1	2	5	50	50	SMA			
US2BG	100	2	70	1	2	5	100	50	SMA			
US2DG	200	2	70	1	2	5	200	50	SMA			
US2GG	400	2	70	1.3	2	5	400	50	SMA			
US2JG	600	2	75	1.65	2	5	600	75	SMA			
US2KG	800	2	75	1.65	2	5	800	75	SMA			
US2MG	1000	2	75	1.65	2	5	1000	75	SMA			
US2ABG	50	2	50	1	2	5	50	50	SMB			
US2BBG	100	2	50	1	2	5	100	50	SMB			
US2DBG	200	2	50	1	2	5	200	50	SMB			
US2GBG	400	2	50	1.3	2	5	400	50	SMB			
US2JBG	600	2	50	1.65	2	5	600	75	SMB			
US2KBG	800	2	50	1.65	2	5	800	75	SMB			
US2MBG	1000	2	50	1.65	2	5	1000	75	SMB			
US3ABG	50	3	90	1	3	5	50	50	SMB			
US3BBG	100	3	90	1	3	5	100	50	SMB			
US3DBG	200	3	90	1	3	5	200	50	SMB			
US3GBG	400	3	90	1.3	3	5	400	50	SMB			
US3JBG	600	3	90	1.65	3	5	600	75	SMB			
US3KBG	800	3	90	1.65	3	5	800	75	SMB			
US3MBG	1000	3	90	1.65	3	5	1000	75	SMB			
US5ABG	50	5	100	1	5	5	50	50	SMB			
US5BBG	100	5	100	1	5	5	100	50	SMB			
US5DBG	200	5	100	1	5	5	200	50	SMB			
US5GBG	400	5	100	1.3	5	5	400	50	SMB			
US5JBG	600	5	100	1.68	5	5	600	75	SMB			
US5KBG	800	5	100	1.68	5	5	800	75	SMB			
US5MBG	1000	5	100	1.68	5	5	1000	75	SMB			

TYPE 型號	PARAMETER 參數	VRRM	I(AV)	IFSM	VF		IR		TRR	Package
					V	A	μA	VR		
US3ACG	50	3	90	1	3	5	50	50	SMC	
US3BCG	100	3	90	1	3	5	100	50	SMC	
US3DCG	200	3	90	1	3	5	200	50	SMC	
US3GCG	400	3	90	1.3	3	5	400	50	SMC	
US3JCG	600	3	90	1.68	3	5	600	75	SMC	
US3KCG	800	3	90	1.68	3	5	800	75	SMC	
US3MCG	1000	3	90	1.68	3	5	1000	75	SMC	
US5ACG	50	5	120	1	5	5	50	50	SMC	
US5BCG	100	5	120	1	5	5	100	50	SMC	
US5DCG	200	5	120	1	5	5	200	50	SMC	
US5GCG	400	5	120	1.3	5	5	400	50	SMC	
US5JCG	600	5	120	1.65	5	5	600	75	SMC	
US5KCG	800	5	120	1.65	5	5	800	75	SMC	
US5MCG	1000	5	120	1.65	5	5	1000	75	SMC	
US8ACG	50	8	150	1	8	10	50	50	SMC	
US5BCG	100	8	150	1	8	10	100	50	SMC	
US5CCG	200	8	150	1	8	10	200	50	SMC	
US5DCG	400	8	150	1.3	8	10	400	50	SMC	
US5ECG	600	8	150	1.7	8	10	600	80	SMC	
US5FCG	800	8	150	1.7	8	10	800	80	SMC	
US5GCG	1000	8	150	1.7	8	10	1000	80	SMC	
US1AW	50	1	25	1	1	5	50	50	SOD-123FL	
US1BW	100	1	25	1	1	5	100	50	SOD-123FL	
US1DW	200	1	25	1	1	5	200	50	SOD-123FL	
US1GW	400	1	25	1.4	1	5	400	50	SOD-123FL	
US1JW	600	1	25	1.7	1	5	600	75	SOD-123FL	
US1KW	800	1	25	1.7	1	5	800	75	SOD-123FL	
US1MW	1000	1	25	1.7	1	5	1000	75	SOD-123FL	
US2AW	50	2	50	1	2	5	50	50	SOD-123FL	
US2BW	100	2	50	1	2	5	100	50	SOD-123FL	
US2DW	200	2	50	1	2	5	200	50	SOD-123FL	
US2GW	400	2	50	1.4	2	5	400	50	SOD-123FL	
US2JW	600	2	50	1.68	2	5	600	75	SOD-123FL	
US2KW	800	2	50	1.68	2	5	800	75	SOD-123FL	
US2MW	1000	2	50	1.68	2	5	1000	75	SOD-123FL	

SUPER FAST RECTIFIERS

超快恢復整流管

TYPE 型號	PARAMETER 參數	VRRM	I(AV)	IFSM	VF		IR		TRR	Package
					V	A	μA	VR		
ES1AF	50	1	30	1	1	5	50	35	SMAF	
ES1BF	100	1	30	1	1	5	100	35	SMAF	
ES1CF	150	1	30	1	1	5	150	35	SMAF	
ES1DF	200	1	30	1	1	5	200	35	SMAF	
ES1EF	300	1	30	1.25	1	5	300	35	SMAF	
ES1GF	400	1	30	1.25	1	5	400	35	SMAF	
ES1JF	600	1	30	1.7	1	5	600	35	SMAF	

PARAMETER TYPE 參數 型號	VRRM	I(AV)	IFSM	VF		IR		T _{RR}	Package
	V	A	A	V	IF	μA	V _R	NS	
				V	A		V		
ES2AF	50	2	50	1	2	5	50	35	SMAF
ES2BF	100	2	50	1	2	5	100	35	SMAF
ES2CF	150	2	50	1	2	5	150	35	SMAF
ES2DF	200	2	50	1	2	5	200	35	SMAF
ES2EF	300	2	50	1.25	2	5	300	35	SMAF
ES2GF	400	2	50	1.25	2	5	400	35	SMAF
ES2JF	600	2	50	1.7	2	5	600	35	SMAF
ES3AF	50	3	100	1	3	5	50	35	SMAF
ES3BF	100	3	100	1	3	5	100	35	SMAF
ES3CF	150	3	100	1	3	5	150	35	SMAF
ES3DF	200	3	100	1	3	5	200	35	SMAF
ES3EF	300	3	100	1.25	3	5	300	35	SMAF
ES3GF	400	3	100	1.25	3	5	400	35	SMAF
ES3JF	600	3	100	1.7	3	5	600	35	SMAF
ES2ABF	50	2	50	1	2	5	50	35	SMBF
ES2BBF	100	2	50	1	2	5	100	35	SMBF
ES2CBF	150	2	50	1	2	5	150	35	SMBF
ES2DBF	200	2	50	1	2	5	200	35	SMBF
ES2EBF	300	2	50	1.25	2	5	300	35	SMBF
ES2GBF	400	2	50	1.25	2	5	400	35	SMBF
ES2JBF	600	2	50	1.65	2	5	600	35	SMBF
ES3ABF	50	3	100	1	3	5	50	35	SMBF
ES3BBF	100	3	100	1	3	5	100	35	SMBF
ES3CBF	150	3	100	1	3	5	150	35	SMBF
ES3DBF	200	3	100	1	3	5	200	35	SMBF
ES3EBF	300	3	100	1.25	3	5	300	35	SMBF
ES3GBF	400	3	100	1.25	3	5	400	35	SMBF
ES3JBF	600	3	100	1.65	3	5	600	35	SMBF
ES5ABF	50	5	150	1	5	10	50	35	SMBF
ES5BBF	100	5	150	1	5	10	100	35	SMBF
ES5CBF	150	5	150	1	5	10	150	35	SMBF
ES5DBF	200	5	150	1	5	10	200	35	SMBF
ES5EBF	300	5	135	1.25	5	10	300	35	SMBF
ES5GBF	400	5	135	1.25	5	10	400	35	SMBF
ES5JBF	600	5	135	1.7	5	10	600	35	SMBF
ES1AG	50	1	30	0.95	1	5	50	35	SMA
ES1BG	100	1	30	0.95	1	5	100	35	SMA
ES1CG	150	1	30	0.95	1	5	150	35	SMA
ES1DG	200	1	30	0.95	1	5	200	35	SMA
ES1EG	300	1	30	1.25	1	5	300	35	SMA
ES1GG	400	1	30	1.25	1	5	400	35	SMA
ES1JG	600	1	30	1.25	1	5	600	35	SMA
ES2AG	50	2	50	1	2	5	50	35	SMA
ES2BG	100	2	50	1	2	5	100	35	SMA
ES2CG	150	2	50	1	2	5	150	35	SMA
ES2DG	200	2	50	1	2	5	200	35	SMA
ES2EG	300	2	50	1.25	2	5	300	35	SMA
ES2GG	400	2	50	1.25	2	5	400	35	SMA
ES2JG	600	2	50	1.68	2	5	600	35	SMA
ES2DLG	200	2	40	1	2	5	200	35	SMB
ES2ELG	300	2	40	1.25	2	5	300	35	SMB
ES2GLG	400	2	40	1.25	2	5	400	35	SMB
ES2JLG	200	2	40	1.68	2	5	200	35	SMB

TYPE 型號	PARAMETER 參數	VRRM	I(AV)	IFSM	VF		IR		TRR	Package			
	V				A	A	V	IF			μA	VR	NS
	V				A	A	V	A			μA	V	NS
ER2A		50	2	50	0.95	2	5	50	35	SMB			
ER2B		100	2	50	0.95	2	5	100	35	SMB			
ER2C		150	2	50	0.95	2	5	150	35	SMB			
ER2D		200	2	50	0.95	2	5	200	35	SMB			
ER2E		300	2	50	1.25	2	5	300	35	SMB			
ER2G		400	2	50	1.25	2	5	400	35	SMB			
ER2J		600	2	50	1.7	2	5	600	35	SMB			
ES2ABG		50	2	60	1	2	5	50	35	SMB			
ES2BBG		100	2	60	1	2	5	100	35	SMB			
ES2CBG		150	2	60	1	2	5	150	35	SMB			
ES2DBG		200	2	60	1	2	5	200	35	SMB			
ES2EBG		300	2	60	1.25	2	5	300	35	SMB			
ES2GBG		400	2	60	1.25	2	5	400	35	SMB			
ES2JBG		600	2	60	1.68	2	5	600	35	SMB			
ES3ABG		50	3	90	1	3	5	50	35	SMB			
ES3BBG		100	3	90	1	3	5	100	35	SMB			
ES3CBG		150	3	90	1	3	5	150	35	SMB			
ES3DBG		200	3	90	1	3	5	200	35	SMB			
ES3EBG		300	3	90	1.25	3	5	300	35	SMB			
ES3GBG		400	3	90	1.25	3	5	400	35	SMB			
ES3JBG		600	3	90	1.68	3	5	600	35	SMB			
ES5ABG		50	5	100	1	5	5	50	35	SMB			
ES5BBG		100	5	100	1	5	5	100	35	SMB			
ES5CBG		150	5	100	1	5	5	150	35	SMB			
ES5DBG		200	5	100	1	5	5	200	35	SMB			
ES5EBG		300	5	100	1.25	5	5	300	35	SMB			
ES5GBG		400	5	100	1.25	5	5	400	35	SMB			
ES5JBG		600	5	100	1.7	5	5	600	35	SMB			
ER3A		50	3	100	0.95	3	5	50	35	SMC			
ER3B		100	3	100	0.95	3	5	100	35	SMC			
ER3C		150	3	100	0.95	3	5	150	35	SMC			
ER3D		200	3	100	0.95	3	5	200	35	SMC			
ER3E		300	3	100	1.25	3	5	300	35	SMC			
ER3G		400	3	100	1.25	3	5	400	35	SMC			
ER3J		600	3	100	1.7	3	5	600	35	SMC			
ES3ACG		50	3	90	1	3	5	50	35	SMC			
ES3BCG		100	3	90	1	3	5	100	35	SMC			
ES3CCG		150	3	90	1	3	5	150	35	SMC			
ES3DCG		200	3	90	1	3	5	200	35	SMC			
ES3ECG		300	3	90	1.25	3	5	300	35	SMC			
ES3GCG		400	3	90	1.25	3	5	400	35	SMC			
ES3JCG		600	3	90	1.68	3	5	600	35	SMC			
ES5ACG		50	5	120	1	5	5	50	35	SMC			
ES5BCG		100	5	120	1	5	5	100	35	SMC			
ES5CCG		150	5	120	1	5	5	150	35	SMC			
ES5DCG		200	5	120	1	5	5	200	35	SMC			
ES5ECG		300	5	120	1.25	5	5	300	35	SMC			
ES5GCG		400	5	120	1.25	5	5	400	35	SMC			
ES5JCG		600	5	120	1.68	5	5	600	35	SMC			
ES8A		50	8	150	1.35	8	10	50	10	SMC			
ES8B		100	8	150	1.35	8	10	100	10	SMC			
ES8D		200	8	150	1.35	8	10	200	10	SMC			
ES8G		400	8	150	1.35	8	10	400	10	SMC			
ES8J		600	8	150	1.35	8	10	600	10	SMC			

TYPE 型號	PARAMETER 參數	VRRM	I(AV)	IFSM	VF		IR		TRR	Package
						IF		VR		
					V	A	μA	V		
ES1AW	50	1	30	1	1	5	50	35	SOD-123FL	
ES1BW	100	1	30	1	1	5	100	35	SOD-123FL	
ES1CW	150	1	30	1	1	5	150	35	SOD-123FL	
ES1DW	200	1	30	1	1	5	200	35	SOD-123FL	
ES1EW	300	1	30	1.25	1	5	300	35	SOD-123FL	
ES1GW	400	1	30	1.25	1	5	400	35	SOD-123FL	
ES1JW	600	1	30	1.7	1	5	600	35	SOD-123FL	
ES2AW	50	2	50	1	2	5	50	35	SOD-123FL	
ES2BW	100	2	50	1	2	5	100	35	SOD-123FL	
ES2CW	150	2	50	1	2	5	150	35	SOD-123FL	
ES2DW	200	2	50	1	2	5	200	35	SOD-123FL	
ES2EW	300	2	50	1.25	2	5	300	35	SOD-123FL	
ES2GW	400	2	50	1.25	2	5	400	35	SOD-123FL	
ES2JW	600	2	50	1.68	2	5	600	35	SOD-123FL	
SF501DS	100	5	150	0.95	5	1	100	35	TO-252	
SF502DS	200	5	150	0.95	5	1	200	35	TO-252	
SF503DS	300	5	150	1.3	5	1	300	35	TO-252	
SF504DS	400	5	150	1.3	5	1	400	35	TO-252	
SF505DS	500	5	150	1.7	5	1	500	35	TO-252	
SF506DS	600	5	150	1.7	5	1	600	35	TO-252	

3-PIN SUPER FAST RECTIFIERS

3-Pin超快恢復整流管

TYPE 型號	PARAMETER 參數	VRRM	I(AV)	IFSM	VF		IR		TRR	Package
						IF		VR		
					V	A	μA	V		
SF301DS	100	3	130	0.95	3	1	100	35	TO-252	
SF302DS	200	3	130	0.95	3	1	200	35	TO-252	
SF303DS	300	3	130	1.3	3	1	300	35	TO-252	
SF304DS	400	3	130	1.3	3	1	400	35	TO-252	
SF305DS	500	3	130	1.7	3	1	500	35	TO-252	
SF306DS	600	3	130	1.7	3	1	600	35	TO-252	
SF307DS	100	5	150	0.95	5	1	100	35	TO-252	
SF308DS	200	5	150	0.95	5	1	200	35	TO-252	
SF309DS	300	5	150	1.3	5	1	300	35	TO-252	
SF310DS	400	5	150	1.3	5	1	400	35	TO-252	
SF311DS	500	5	150	1.7	5	1	500	35	TO-252	
SF312DS	600	5	150	1.7	5	1	600	35	TO-252	
SF313DS	800	5	150	2.3	5	1	800	35	TO-252	
SF314DS	100	8	160	0.95	8	1	100	35	TO-252	
SF315DS	200	8	160	0.95	8	1	200	35	TO-252	
SF316DS	300	8	160	1.3	8	1	300	35	TO-252	
SF317DS	400	8	160	1.3	8	1	400	35	TO-252	
SF318DS	500	8	160	1.7	8	1	500	35	TO-252	
SF319DS	600	8	160	1.7	8	1	600	35	TO-252	
SF320DS	100	10	170	0.95	10	1	100	35	TO-252	
SF321DS	200	10	170	0.95	10	1	200	35	TO-252	
SF322DS	300	10	170	1.3	10	1	300	35	TO-252	
SF323DS	400	10	170	1.3	10	1	400	35	TO-252	
SF324DS	500	10	170	1.7	10	1	500	35	TO-252	
SF325DS	600	10	170	1.7	10	1	600	35	TO-252	

PARAMETER TYPE 型號	V _{RRM} V	PIN ARRAY V	I(AV) A	I _{FSM} A	V _F		I _R		T _{RR} NS	Package
					V	I _F A	μA	V _R V		
MUR1620CT	200	共陰	16	100	0.975	16	5	200	25	TO-220
MUR1640CT	400	共陰	16	100	1.3	16	10	400	50	TO-220
MUR1660CT	600	共陰	16	100	1.5	16	10	600	50	TO-220
MUR1620AT	200	共陽	16	100	0.975	16	5	200	25	TO-220
MUR1640AT	400	共陽	16	100	1.3	16	10	400	50	TO-220
MUR1660AT	600	共陽	16	100	1.5	16	10	600	50	TO-220
MUR1620FAT	200	共陽	16	100	0.975	16	5	200	25	TO-220F
MUR1640FAT	400	共陽	16	100	1.3	16	10	400	50	TO-220F
MUR1660FAT	600	共陽	16	100	1.5	16	10	600	50	TO-220F
FFA60U60CT	600	共陰	60	360	2.2	60	25	600	90	TO-3PNB

BRIDGE RECTIFIERS

橋式整流器

PARAMETER TYPE 型號	V(DC) V	I _F A	I _{FSM} A	V _F		I _R		Package
				V	I _F A	μA	V _R V	
LUM1B	100	1	35	1.1	1	5	100	UMB
LUM2B	200	1	35	1.1	1	5	200	UMB
LUM4B	400	1	35	1.1	1	5	400	UMB
LUM6B	600	1	35	1.1	1	5	600	UMB
LUM8B	800	1	35	1.1	1	5	800	UMB
LUM10B	1000	1	35	1.1	1	5	1000	UMB
MSB20B	100	2	50	1.1	2	5	100	UMSB
MSB20D	200	2	50	1.1	2	5	200	UMSB
MSB20G	400	2	50	1.1	2	5	400	UMSB
MSB20J	600	2	50	1.1	2	5	600	UMSB
MSB20K	800	2	50	1.1	2	5	800	UMSB
MSB20M	1000	2	50	1.1	2	5	1000	UMSB
MSB30B	100	3	80	1.1	3	5	100	UMSB
MSB30D	200	3	80	1.1	3	5	200	UMSB
MSB30G	400	3	80	1.1	3	5	400	UMSB
MSB30J	600	3	80	1.1	3	5	600	UMSB
MSB30K	800	3	80	1.1	3	5	800	UMSB
MSB30M	1000	3	80	1.1	3	5	1000	UMSB
MSB40B	100	4	95	1.1	4	5	100	UMSB
MSB40D	200	4	95	1.1	4	5	200	UMSB
MSB40G	400	4	95	1.1	4	5	400	UMSB
MSB40J	600	4	95	1.1	4	5	600	UMSB
MSB40K	800	4	95	1.1	4	5	800	UMSB
MSB40M	1000	4	95	1.1	4	5	1000	UMSB
DBF302S	100	3	110	1	3	5	100	DBF
DBF303S	200	3	110	1	3	5	200	DBF
DBF304S	400	3	110	1	3	5	400	DBF
DBF305S	600	3	110	1	3	5	600	DBF
DBF306S	800	3	110	1	3	5	800	DBF
DBF307S	1000	3	110	1	3	5	1000	DBF

TYPE 型號	PARAMETER 參數	V(DC)	I _F	I _{FSM}	V _F		I _R		Package
						I _F		V _R	
					V	A	μA	V	
ABS1		100	0.8	30	1.1	0.8	5	100	ABS
ABS2		200	0.8	30	1.1	0.8	5	200	ABS
ABS4		400	0.8	30	1.1	0.8	5	400	ABS
ABS6		600	0.8	30	1.1	0.8	5	600	ABS
ABS8		800	0.8	30	1.1	0.8	5	800	ABS
ABS10		1000	0.8	30	1.1	0.8	5	1000	ABS
TB1S		100	0.8	25	1.1	0.8	5	100	ABS
TB2S		200	0.8	25	1.1	0.8	5	200	ABS
TB4S		400	0.8	25	1.1	0.8	5	400	ABS
TB6S		600	0.8	25	1.1	0.8	5	600	ABS
TB8S		800	0.8	25	1.1	0.8	5	800	ABS
TB10S		1000	0.8	25	1.1	0.8	5	1000	ABS
TB1S-10		100	1	35	1.1	1	5	100	ABS
TB2S-10		200	1	35	1.1	1	5	200	ABS
TB4S-10		400	1	35	1.1	1	5	400	ABS
TB6S-10		600	1	35	1.1	1	5	600	ABS
TB8S-10		800	1	35	1.1	1	5	800	ABS
TB10S-10		1000	1	35	1.1	1	5	1000	ABS
ABS1K		100	1.2	40	1.1	1.2	5	100	ABS
ABS2K		200	1.2	40	1.1	1.2	5	200	ABS
ABS4K		400	1.2	40	1.1	1.2	5	400	ABS
ABS6K		600	1.2	40	1.1	1.2	5	600	ABS
ABS8K		800	1.2	40	1.1	1.2	5	800	ABS
ABS10K		1000	1.2	40	1.1	1.2	5	1000	ABS
ABS201		100	2	50	1	2	5	100	ABS
ABS202		200	2	50	1	2	5	200	ABS
ABS204		400	2	50	1	2	5	400	ABS
ABS206		600	2	50	1	2	5	600	ABS
ABS208		800	2	50	1	2	5	800	ABS
ABS210		1000	2	50	1	2	5	1000	ABS
MB2S		200	0.8	30	1	0.4	5	200	MBS
MB4S		400	0.8	30	1	0.4	5	400	MBS
MB6S		600	0.8	30	1	0.4	5	500	MBS
MB8S		800	0.8	30	1	0.4	5	800	MBS
MB10S		1000	0.8	30	1	0.4	5	1000	MBS
HD01		100	0.8	30	1.1	0.8	5	100	MBS
HD02		200	0.8	30	1.1	0.8	5	200	MBS
HD04		400	0.8	30	1.1	0.8	5	400	MBS
HD06		600	0.8	30	1.1	0.8	5	600	MBS
HD08		800	0.8	30	1.1	0.8	5	800	MBS
HD10		1000	0.8	30	1.1	0.8	5	1000	MBS
MB1SK		100	1	35	1.1	1	5	100	MBS
MB2SK		200	1	35	1.1	1	5	200	MBS
MB4SK		400	1	35	1.1	1	5	400	MBS
MB6SK		600	1	35	1.1	1	5	600	MBS
MB8SK		800	1	35	1.1	1	5	800	MBS
MB10SK		1000	1	35	1.1	1	5	1000	MBS
MB1F		100	0.8	25	1.1	0.8	5	100	MBF
MB2F		200	0.8	25	1.1	0.8	5	200	MBF
MB4F		400	0.8	25	1.1	0.8	5	400	MBF
MB6F		600	0.8	25	1.1	0.8	5	600	MBF
MB8F		800	0.8	25	1.1	0.8	5	800	MBF
MB10F		1000	0.8	25	1.1	0.8	5	1000	MBF

TYPE 型號	PARAMETER 參數	V(DC)	I _F	I _{FSM}	V _F		I _R		Package
	V				A	A	V	I _F	
	V	A	A	V	A	μA	V		
MB1FK		100	1	35	1.1	1	5	100	MBF
MB2FK		200	1	35	1.1	1	5	200	MBF
MB4FK		400	1	35	1.1	1	5	400	MBF
MB6FK		600	1	35	1.1	1	5	600	MBF
MB8FK		800	1	35	1.1	1	5	800	MBF
MB10FK		1000	1	35	1.1	1	5	1000	MBF
DB101S		50	1	50	1.1	1	10	50	DBS
DB102S		100	1	50	1.1	1	10	100	DBS
DB103S		200	1	50	1.1	1	10	200	DBS
DB104S		400	1	50	1.1	1	10	400	DBS
DB105S		600	1	50	1.1	1	10	600	DBS
DB106S		800	1	50	1.1	1	10	800	DBS
DB107S		1000	1	50	1.1	1	10	1000	DBS
DB151S		50	1.5	55	1.1	1.5	5	50	DBS
DB152S		100	1.5	55	1.1	1.5	5	100	DBS
DB153S		200	1.5	55	1.1	1.5	5	200	DBS
DB154S		400	1.5	55	1.1	1.5	5	400	DBS
DB155S		600	1.5	55	1.1	1.5	5	600	DBS
DB156S		800	1.5	55	1.1	1.5	5	800	DBS
DB157S		1000	1.5	55	1.1	1.5	5	1000	DBS
DB201S		50	2	60	1.1	2	5	50	DBS
DB202S		100	2	60	1.1	2	5	100	DBS
DB203S		200	2	60	1.1	2	5	200	DBS
DB204S		400	2	60	1.1	2	5	400	DBS
DB205S		600	2	60	1.1	2	5	600	DBS
DB206S		800	2	60	1.1	2	5	800	DBS
DB207S		1000	2	60	1.1	2	5	1000	DBS
KBP005G		50	1.5	45	1.1	1.5	5	50	KBP
KBP01G		100	1.5	45	1.1	1.5	5	100	KBP
KBP02G		200	1.5	45	1.1	1.5	5	200	KBP
KBP04G		400	1.5	45	1.1	1.5	5	400	KBP
KBP06G		600	1.5	45	1.1	1.5	5	600	KBP
KBP08G		800	1.5	45	1.1	1.5	5	800	KBP
KBP10G		1000	1.5	45	1.1	1.5	5	1000	KBP
KBP2005		50	2	45	1.1	2	5	50	KBP
KBP201		100	2	45	1.1	2	5	100	KBP
KBP202		200	2	45	1.1	2	5	200	KBP
KBP204		400	2	45	1.1	2	5	400	KBP
KBP206		600	2	45	1.1	2	5	600	KBP
KBP208		800	2	45	1.1	2	5	800	KBP
KBP210		1000	2	45	1.1	2	5	1000	KBP
KBP2005G		50	2	55	1.1	2	5	50	KBP
KBP201G		100	2	55	1.1	2	5	100	KBP
KBP202G		200	2	55	1.1	2	5	200	KBP
KBP204G		400	2	55	1.1	2	5	400	KBP
KBP206G		600	2	55	1.1	2	5	600	KBP
KBP208G		800	2	55	1.1	2	5	800	KBP
KBP210G		1000	2	55	1.1	2	5	1000	KBP
KBP3005		50	3	55	1.1	3	5	50	KBP
KBP301		100	3	55	1.1	3	5	100	KBP
KBP302		200	3	55	1.1	3	5	200	KBP
KBP304		400	3	55	1.1	3	5	400	KBP
KBP306		600	3	55	1.1	3	5	600	KBP
KBP308		800	3	55	1.1	3	5	800	KBP
KBP310		1000	3	55	1.1	3	5	1000	KBP

TYPE 型號	PARAMETER 參數	V(DC)	IF	IFSM	VF		IR		Package
	V				A	A	V	IF	
	V	A	A	V	A	μA	V		
KBP3005G		50	3	75	1.1	3	5	50	KBP
KBP301G		100	3	75	1.1	3	5	100	KBP
KBP302G		200	3	75	1.1	3	5	200	KBP
KBP304G		400	3	75	1.1	3	5	400	KBP
KBP306G		600	3	75	1.1	3	5	600	KBP
KBP308G		800	3	75	1.1	3	5	800	KBP
KBP310G		1000	3	75	1.1	3	5	1000	KBP
KBP4005		50	4	75	1.1	4	5	50	KBP
KBP401		100	4	75	1.1	4	5	100	KBP
KBP402		200	4	75	1.1	4	5	200	KBP
KBP404		400	4	75	1.1	4	5	400	KBP
KBP406		600	4	75	1.1	4	5	600	KBP
KBP408		800	4	75	1.1	4	5	800	KBP
KBP410		1000	4	75	1.1	4	5	1000	KBP
KBP4005G		50	4	130	1.1	4	5	50	KBP
KBP401G		100	4	130	1.1	4	5	100	KBP
KBP402G		200	4	130	1.1	4	5	200	KBP
KBP404G		400	4	130	1.1	4	5	400	KBP
KBP406G		600	4	130	1.1	4	5	600	KBP
KBP408G		800	4	130	1.1	4	5	800	KBP
KBP410G		1000	4	130	1.1	4	5	1000	KBP
KBL4005		50	4	125	1.1	4	10	50	KBL
KBL401		100	4	125	1.1	4	10	100	KBL
KBL402		200	4	125	1.1	4	10	200	KBL
KBL404		400	4	125	1.1	4	10	400	KBL
KBL406		600	4	125	1.1	4	10	600	KBL
KBL408		800	4	125	1.1	4	10	800	KBL
KBL410		1000	4	125	1.1	4	10	1000	KBL
GBU4A		50	4	150	1	2	5	50	GBU
GBU4B		100	4	150	1	2	5	100	GBU
GBU4D		200	4	150	1	2	5	200	GBU
GBU4G		400	4	150	1	2	5	400	GBU
GBU4J		600	4	150	1	2	5	600	GBU
GBU4K		800	4	150	1	2	5	800	GBU
GBU4M		1000	4	150	1	2	5	1000	GBU
GBU6A		50	6	175	1	3	5	50	GBU
GBU6B		100	6	175	1	3	5	100	GBU
GBU6D		200	6	175	1	3	5	200	GBU
GBU6G		400	6	175	1	3	5	400	GBU
GBU6J		600	6	175	1	3	5	600	GBU
GBU6K		800	6	175	1	3	5	800	GBU
GBU6M		1000	6	175	1	3	5	1000	GBU
GBU8A		50	8	200	1	4	5	50	GBU
GBU8B		100	8	200	1	4	5	100	GBU
GBU8D		200	8	200	1	4	5	200	GBU
GBU8G		400	8	200	1	4	5	400	GBU
GBU8J		600	8	200	1	4	5	600	GBU
GBU8K		800	8	200	1	4	5	800	GBU
GBU8M		1000	8	200	1	4	5	1000	GBU
GBU10A		50	10	220	1	5	5	50	GBU
GBU10B		100	10	220	1	5	5	100	GBU
GBU10D		200	10	220	1	5	5	200	GBU
GBU10G		400	10	220	1	5	5	400	GBU
GBU10J		600	10	220	1	5	5	600	GBU
GBU10K		800	10	220	1	5	5	800	GBU
GBU10M		1000	10	220	1	5	5	1000	GBU

TYPE 型號	PARAMETER 參數	VDC	IF	IFSM	VF		IR		Package
		V	A	A	V	A	μA	VR	
								V	
GBU15A	50	15	220	1.1	7.5	5	50	GBU	
GBU15B	100	15	220	1.1	7.5	5	100	GBU	
GBU15D	200	15	220	1.1	7.5	5	200	GBU	
GBU15G	400	15	220	1.1	7.5	5	400	GBU	
GBU15J	600	15	220	1.1	7.5	5	600	GBU	
GBU15K	800	15	220	1.1	7.5	5	800	GBU	
GBU15M	1000	15	220	1.1	7.5	5	1000	GBU	
GBU20A	50	20	240	1	10	5	50	GBU	
GBU20B	100	20	240	1	10	5	100	GBU	
GBU20D	200	20	240	1	10	5	200	GBU	
GBU20G	400	20	240	1	10	5	400	GBU	
GBU20J	600	20	240	1	10	5	600	GBU	
GBU20K	800	20	240	1	10	5	800	GBU	
GBU20M	1000	20	240	1	10	5	1000	GBU	
GBJ6A	50	6	150	1	3	5	50	GBJ	
GBJ6B	100	6	150	1	3	5	100	GBJ	
GBJ6D	200	6	150	1	3	5	200	GBJ	
GBJ6G	400	6	150	1	3	5	400	GBJ	
GBJ6J	600	6	150	1	3	5	600	GBJ	
GBJ6K	800	6	150	1	3	5	800	GBJ	
GBJ6M	1000	6	150	1	3	5	1000	GBJ	
GBJ6AG	50	6	175	1	3	5	50	GBJ	
GBJ6BG	100	6	175	1	3	5	100	GBJ	
GBJ6DG	200	6	175	1	3	5	200	GBJ	
GBJ6GG	400	6	175	1	3	5	400	GBJ	
GBJ6JG	600	6	175	1	3	5	600	GBJ	
GBJ6KG	800	6	175	1	3	5	800	GBJ	
GBJ6MG	1000	6	175	1	3	5	1000	GBJ	
GBJ8A	50	8	175	1	4	5	50	GBJ	
GBJ8B	100	8	175	1	4	5	100	GBJ	
GBJ8D	200	8	175	1	4	5	200	GBJ	
GBJ8G	400	8	175	1	4	5	400	GBJ	
GBJ8J	600	8	175	1	4	5	600	GBJ	
GBJ8K	800	8	175	1	4	5	800	GBJ	
GBJ8M	1000	8	175	1	4	5	1000	GBJ	
GBJ8AG	50	8	200	1	4	5	50	GBJ	
GBJ8BG	100	8	200	1	4	5	100	GBJ	
GBJ8DG	200	8	200	1	4	5	200	GBJ	
GBJ8GG	400	8	200	1	4	5	400	GBJ	
GBJ8JG	600	8	200	1	4	5	600	GBJ	
GBJ8KG	800	8	200	1	4	5	800	GBJ	
GBJ8MG	1000	8	200	1	4	5	1000	GBJ	
GBJ10A	50	10	175	1	5	5	50	GBJ	
GBJ10B	100	10	175	1	5	5	100	GBJ	
GBJ10D	200	10	175	1	5	5	200	GBJ	
GBJ10G	400	10	175	1	5	5	400	GBJ	
GBJ10J	600	10	175	1	5	5	600	GBJ	
GBJ10K	800	10	175	1	5	5	800	GBJ	
GBJ10M	1000	10	175	1	5	5	1000	GBJ	
GBJ10AG	50	10	200	1	5	5	50	GBJ	
GBJ10BG	100	10	200	1	5	5	100	GBJ	
GBJ10DG	200	10	200	1	5	5	200	GBJ	
GBJ10GG	400	10	200	1	5	5	400	GBJ	
GBJ10JG	600	10	200	1	5	5	600	GBJ	
GBJ10KG	800	10	200	1	5	5	800	GBJ	
GBJ10MG	1000	10	200	1	5	5	1000	GBJ	

TYPE 型號	PARAMETER 參數	VDC	IF	IFSM	VF		IR		Package
		V	A	A	V	A	μA	VR	
								V	
GBJ15A	50	15	200	1	7.5	5	50	GBJ	
GBJ15B	100	15	200	1	7.5	5	100	GBJ	
GBJ15D	200	15	200	1	7.5	5	200	GBJ	
GBJ15G	400	15	200	1	7.5	5	400	GBJ	
GBJ15J	600	15	200	1	7.5	5	600	GBJ	
GBJ15K	800	15	200	1	7.5	5	800	GBJ	
GBJ15M	1000	15	200	1	7.5	5	1000	GBJ	
GBJ15AG	50	15	240	1	7.5	5	50	GBJ	
GBJ15BG	100	15	240	1	7.5	5	100	GBJ	
GBJ15DG	200	15	240	1	7.5	5	200	GBJ	
GBJ15GG	400	15	240	1	7.5	5	400	GBJ	
GBJ15JG	600	15	240	1	7.5	5	600	GBJ	
GBJ15KG	800	15	240	1	7.5	5	800	GBJ	
GBJ15MG	1000	15	240	1	7.5	5	1000	GBJ	
GBJ20A	50	20	240	1	10	5	50	GBJ	
GBJ20B	100	20	240	1	10	5	100	GBJ	
GBJ20D	200	20	240	1	10	5	200	GBJ	
GBJ20G	400	20	240	1	10	5	400	GBJ	
GBJ20J	600	20	240	1	10	5	600	GBJ	
GBJ20K	800	20	240	1	10	5	800	GBJ	
GBJ20M	1000	20	240	1	10	5	1000	GBJ	
GBJ20AG	50	20	270	1	10	5	50	GBJ	
GBJ20BG	100	20	270	1	10	5	100	GBJ	
GBJ20DG	200	20	270	1	10	5	200	GBJ	
GBJ20GG	400	20	270	1	10	5	400	GBJ	
GBJ20JG	600	20	270	1	10	5	600	GBJ	
GBJ20KG	800	20	270	1	10	5	800	GBJ	
GBJ20MG	1000	20	270	1	10	5	1000	GBJ	
GBJ25A	50	25	270	1	12.5	5	50	GBJ	
GBJ25B	100	25	270	1	12.5	5	100	GBJ	
GBJ25D	200	25	270	1	12.5	5	200	GBJ	
GBJ25G	400	25	270	1	12.5	5	400	GBJ	
GBJ25J	600	25	270	1	12.5	5	600	GBJ	
GBJ25K	800	25	270	1	12.5	5	800	GBJ	
GBJ25M	1000	25	270	1	12.5	5	1000	GBJ	
GBJ25AG	50	25	300	1	12.5	5	50	GBJ	
GBJ25BG	100	25	300	1	12.5	5	100	GBJ	
GBJ25DG	200	25	300	1	12.5	5	200	GBJ	
GBJ25GG	400	25	300	1	12.5	5	400	GBJ	
GBJ25JG	600	25	300	1	12.5	5	600	GBJ	
GBJ25KG	800	25	300	1	12.5	5	800	GBJ	
GBJ25MG	1000	25	300	1	12.5	5	1000	GBJ	
GBJ35A	50	35	300	1	17.5	5	50	GBJ	
GBJ35B	100	35	300	1	17.5	5	100	GBJ	
GBJ35D	200	35	300	1	17.5	5	200	GBJ	
GBJ35G	400	35	300	1	17.5	5	400	GBJ	
GBJ35J	600	35	300	1	17.5	5	600	GBJ	
GBJ35K	800	35	300	1	17.5	5	800	GBJ	
GBJ35M	1000	35	300	1	17.5	5	1000	GBJ	
GBJ35AG	50	35	350	1	17.5	5	50	GBJ	
GBJ35BG	100	35	350	1	17.5	5	100	GBJ	
GBJ35DG	200	35	350	1	17.5	5	200	GBJ	
GBJ35GG	400	35	350	1	17.5	5	400	GBJ	
GBJ35JG	600	35	350	1	17.5	5	600	GBJ	
GBJ35KG	800	35	350	1	17.5	5	800	GBJ	
GBJ35MG	1000	35	350	1	17.5	5	1000	GBJ	

PARAMETER TYPE 參數 型號	V _{DC}	I _F	I _{FSM}	V _F		I _R		Package
	V	A	A	V	I _F A	μA	V _R V	
	GBJ50AG	50	50	400	1	25	5	
GBJ50BG	100	50	400	1	25	5	100	GBJ
GBJ50DG	200	50	400	1	25	5	200	GBJ
GBJ50GG	400	50	400	1	25	5	400	GBJ
GBJ50JG	600	50	400	1	25	5	600	GBJ
GBJ50KG	800	50	400	1	25	5	800	GBJ
GBJ50MG	1000	50	400	1	25	5	1000	GBJ
3GBJ50K	800	50	450	1.1	50	5	800	SGBJ
3GBJ50M	1000	50	450	1.1	50	5	1000	SGBJ
3GBJ50P	1200	50	450	1.1	50	5	1200	SGBJ
3GBJ50T	1600	50	450	1.1	50	5	1600	SGBJ
SLBF6K	800	6	200	1	6	5	800	ULBF
SLBF6M	1000	6	200	1	6	5	1000	ULBF
SLBF8K	800	8	220	1	4	5	800	ULBF
SLBF8M	1000	8	220	1	4	5	1000	ULBF

FAST RECOVERY RECTIFIER BRIDGES

快恢復橋式整流器

PARAMETER TYPE 參數 型號	V _{RRM}	I _F	I _{FSM}	V _F		I _R		T _{RR}	Package
	V	A	A	V	I _F A	μA	V _R V	NS	
	FMSB20B	100	2	50	1.3	2	5	100	
FMSB20D	200	2	50	1.3	2	5	200	500	UMSB
FMSB20G	400	2	50	1.3	2	5	400	500	UMSB
FMSB20J	600	2	50	1.3	2	5	600	500	UMSB
FMSB20K	800	2	50	1.3	2	5	800	500	UMSB
FMSB20M	1000	2	50	1.3	2	5	1000	500	UMSB
FMSB30B	100	3	90	1.3	3	5	100	150	UMSB
FMSB30D	200	3	90	1.3	3	5	200	150	UMSB
FMSB30G	400	3	90	1.3	3	5	400	150	UMSB
FMSB30J	600	3	90	1.3	3	5	600	250	UMSB
FMSB30K	800	3	90	1.3	3	5	800	500	UMSB
FMSB30M	1000	3	90	1.3	3	5	1000	500	UMSB
FMSB40B	100	4	95	1.3	4	5	100	150	UMSB
FMSB40D	200	4	95	1.3	4	5	200	150	UMSB
FMSB40G	400	4	95	1.3	4	5	400	150	UMSB
FMSB40J	600	4	95	1.3	4	5	600	250	UMSB
FMSB40K	800	4	95	1.3	4	5	800	500	UMSB
FMSB40M	1000	4	95	1.3	4	5	1000	500	UMSB

TYPE 型號	PARAMETER 參數	VRRM	IF	IFSM	VF		IR		TRR	Package			
	V				A	A	V	A			μA	VR	NS
FTB1FK		100	1	35	1.3	1	5	100	500	ABF			
FTB2FK		200	1	35	1.3	1	5	200	500	ABF			
FTB4FK		400	1	35	1.3	1	5	400	500	ABF			
FTB6FK		600	1	35	1.3	1	5	600	500	ABF			
FTB8FK		800	1	35	1.3	1	5	800	500	ABF			
FTB10FK		1000	1	35	1.3	1	5	1000	500	ABF			
FTB1FT		100	2	55	1.3	2	5	100	500	ABF			
FTB2FT		200	2	55	1.3	2	5	200	500	ABF			
FTB4FT		400	2	55	1.3	2	5	400	500	ABF			
FTB6FT		600	2	55	1.3	2	5	600	500	ABF			
FTB8FT		800	2	55	1.3	2	5	800	500	ABF			
FTB10FT		1000	2	55	1.3	2	5	1000	500	ABF			
FTB1SK		100	1	35	1.3	1	5	100	500	ABS			
FTB2SK		200	1	35	1.3	1	5	200	500	ABS			
FTB4SK		400	1	35	1.3	1	5	400	500	ABS			
FTB6SK		600	1	35	1.3	1	5	600	500	ABS			
FTB8SK		800	1	35	1.3	1	5	800	500	ABS			
FTB10SK		1000	1	35	1.3	1	5	1000	500	ABS			
FTB1ST		100	2	50	1.3	2	5	100	350	ABS			
FTB2ST		200	2	50	1.3	2	5	200	350	ABS			
FTB4ST		400	2	50	1.3	2	5	400	350	ABS			
FTB6ST		600	2	50	1.3	2	5	600	350	ABS			
FTB8ST		800	2	50	1.3	2	5	800	350	ABS			
FTB10ST		1000	2	50	1.3	2	5	1000	350	ABS			
SRABS20J		600	2	55	1	1	5	600	500	ABS			
SRABS20K		800	2	55	1	1	5	800	500	ABS			
SRABS20M		1000	2	55	1	1	5	1000	500	ABS			
FMB1SK		100	1	35	1.1	1	5	100	500	MBS			
FMB2SK		200	1	35	1.1	1	5	200	500	MBS			
FMB4SK		400	1	35	1.1	1	5	400	500	MBS			
FMB6SK		600	1	35	1.1	1	5	600	500	MBS			
FMB8SK		800	1	35	1.1	1	5	800	500	MBS			
FMB10SK		1000	1	35	1.1	1	5	1000	500	MBS			
FMB1FK		100	1	35	1.3	1	5	100	500	MBF			
FMB2FK		200	1	35	1.3	1	5	200	500	MBF			
FMB4FK		400	1	35	1.3	1	5	400	500	MBF			
FMB6FK		600	1	35	1.3	1	5	600	500	MBF			
FMB8FK		800	1	35	1.3	1	5	800	500	MBF			
FMB10FK		1000	1	35	1.3	1	5	1000	500	MBF			
SLBF5M		1000	5	180	1	5	1	1000	500	ULBF			

HIGH EFFICIENCY RECTIFIER BRIDGES

高效橋式整流器

TYPE 型號	PARAMETER 參數	VRRM	IF	IFSM	VF		IR		TRR	Package		
	V				A	A	V	A			μA	VR
	V				A	A	V	A			μA	V
UMSB30B		100	3	80	1	3	5	100	50	UMSB		
UMSB30D		200	3	80	1	3	5	200	50	UMSB		
UMSB30G		400	3	80	1.4	3	5	400	50	UMSB		
UMSB30J		600	3	80	1.6	3	5	600	75	UMSB		
UMSB30K		800	3	80	1.6	3	5	800	75	UMSB		
UMSB30M		1000	3	80	1.6	3	5	1000	75	UMSB		
UMSB40B		100	4	95	1	4	5	100	50	UMSB		
UMSB40D		200	4	95	1	4	5	200	50	UMSB		
UMSB40G		400	4	95	1.4	4	5	400	50	UMSB		
UMSB40J		600	4	95	1.6	4	5	600	75	UMSB		
UMSB40K		800	4	95	1.6	4	5	800	75	UMSB		
UMSB40M		1000	4	95	1.6	4	5	1000	75	UMSB		
UTB1SK		100	1	35	1	1	5	100	50	ABS		
UTB2SK		200	1	35	1	1	5	200	50	ABS		
UTB4SK		400	1	35	1.3	1	5	400	50	ABS		
UTB6SK		600	1	35	1.5	1	5	600	75	ABS		
UTB8SK		800	1	35	1.5	1	5	800	75	ABS		
UTB10SK		1000	1	35	1.5	1	5	1000	75	ABS		
UTB1SH		100	1.5	50	1	1.5	5	100	50	ABS		
UTB2SH		200	1.5	50	1	1.5	5	200	50	ABS		
UTB4SH		400	1.5	50	1.4	1.5	5	400	50	ABS		
UTB6SH		600	1.5	50	1.6	1.5	5	600	75	ABS		
UTB8SH		800	1.5	50	1.6	1.5	5	800	75	ABS		
UTB10SH		1000	1.5	50	1.6	1.5	5	1000	75	ABS		
UMB1SK		100	1	35	1	1	5	100	50	MBS		
UMB2SK		200	1	35	1	1	5	200	50	MBS		
UMB4SK		400	1	35	1.3	1	5	400	50	MBS		
UMB6SK		600	1	35	1.5	1	5	600	75	MBS		
UMB8SK		800	1	35	1.5	1	5	800	75	MBS		
UMB10SK		1000	1	35	1.5	1	5	1000	75	MBS		
UMB1FK		100	1	35	1	1	5	100	50	MBF		
UMB2FK		200	1	35	1	1	5	200	50	MBF		
UMB4FK		400	1	35	1.3	1	5	400	50	MBF		
UMB6FK		600	1	35	1.5	1	5	600	75	MBF		
UMB8FK		800	1	35	1.5	1	5	800	75	MBF		
UMB10FK		1000	1	35	1.5	1	5	1000	75	MBF		

SUPER FAST RECOVERY RECTIFIER BRIDGES

超快恢復橋式整流器

PARAMETER TYPE 參數 型號	V _{DC}	I _F	I _{FSM}	V _F		I _R		T _{RR}	Package
	V	A	A	V	A	μA	V	NS	
	EABS21	100	2	50	0.95	2	5	100	
EABS22	200	2	50	0.95	2	5	200	35	ABS
EABS24	400	2	50	1.25	2	5	400	35	ABS
EABS26	600	2	50	1.7	2	5	600	35	ABS

SCHOTTKY BRIDGES

肖特基整流橋

PARAMETER TYPE 參數 型號	V _{RRM}	I _F	I _{FSM}	V _F		I _R		Package
	V	A	A	V	A	μA	V	
	TB14S	40	1	40	0.55	1	300	
TB16S	60	1	40	0.7	1	300	60	ABS
TB18S	80	1	30	0.85	1	200	80	ABS
TB110S	100	1	30	0.85	1	200	100	ABS
TB115S	150	1	30	0.85	1	100	150	ABS
TB120S	200	1	30	0.85	1	100	200	ABS
TB24S	40	2	50	0.55	2	500	40	ABS
TB26S	60	2	50	0.7	2	500	60	ABS
TB28S	80	2	40	0.85	2	500	80	ABS
TB210S	100	2	40	0.85	2	300	100	ABS
TB215S	150	2	40	0.85	2	300	150	ABS
TB220S	200	2	40	0.85	2	300	200	ABS
TB34S	40	3	80	0.55	3	500	40	ABS
TB36S	60	3	80	0.7	3	300	60	ABS
TB38S	80	3	70	0.85	3	300	80	ABS
TB310S	100	3	70	0.85	3	300	100	ABS
TB315S	150	3	70	0.95	3	300	150	ABS
TB320S	200	3	70	0.95	3	300	200	ABS
MB14S	40	1	40	0.55	1	300	40	MBS
MB16S	60	1	40	0.7	1	300	60	MBS
MB18S	80	1	40	0.7	1	300	80	MBS
MB110S	100	1	30	0.85	1	200	100	MBS
MB115S	150	1	30	0.9	1	100	150	MBS
MB120S	200	1	30	0.9	1	100	200	MBS

PARAMETER TYPE 參數 型號	VRRM	IF	IFSM	VF		IR		Package		
				V	A	V	A		μA	VR
MB24S	40	2	50	0.55	2	500	40	MBS		
MB26S	60	2	50	0.7	2	500	60	MBS		
MB28S	80	2	40	0.85	2	500	80	MBS		
MB210S	100	2	40	0.85	2	300	100	MBS		
MB215S	150	2	40	0.85	2	300	150	MBS		
MB220S	200	2	40	0.85	2	300	200	MBS		
MB34S	40	3	80	0.55	3	500	40	MBS		
MB36S	60	3	80	0.7	3	300	60	MBS		
MB38S	80	3	70	0.85	3	300	80	MBS		
MB310S	100	3	70	0.85	3	300	100	MBS		
MB315S	150	3	70	0.95	3	300	150	MBS		
MB320S	200	3	70	0.95	3	300	200	MBS		
MB24F	40	2	50	0.55	2	500	40	MBF		
MB26F	60	2	50	0.7	2	500	60	MBF		
MB28F	80	2	40	0.85	2	500	80	MBF		
MB210F	100	2	40	0.85	2	300	100	MBF		
MB215F	150	2	40	0.85	2	300	150	MBF		
MB220F	200	2	40	0.85	2	300	200	MBF		
MB34F	40	3	80	0.55	3	500	40	MBF		
MB36F	60	3	80	0.7	3	500	60	MBF		
MB38F	80	3	70	0.85	3	500	80	MBF		
MB310F	100	3	70	0.85	3	300	100	MBF		
MB315F	150	3	70	0.95	3	300	150	MBF		
MB320F	200	3	70	0.95	3	300	200	MBF		
MB14FK	40	1	40	0.55	1	300	40	MBF		
MB16FK	60	1	40	0.7	1	300	60	MBF		
MB18FK	80	1	40	0.7	1	300	80	MBF		
MB110FK	100	1	30	0.85	1	200	100	MBF		
MB115FK	150	1	30	0.9	1	100	150	MBF		
MB120FK	200	1	30	0.9	1	100	200	MBF		

ZENER DIODES

穩壓二極管

PARAMETER TYPE 參數 型號	Zener Voltage Rang			IZT	Dynamic Impedance ZzT(@IZT) Max(Ω)	Reverse Current		Power Dissipation PD mW	Package
	VZT(@IZT)					IR	@VR		
	MIN(V)	NOM(V)	MAX(V)						
1SMAF4728A	3.1	3.3	3.5	75	10	100	1	1000	SMAF
1SMAF4729A	3.4	3.6	3.8	69	10	100	1	1000	SMAF
1SMAF4730A	3.7	3.9	4.1	64	9	50	1	1000	SMAF
1SMAF4731A	4.06	4.3	4.56	58	9	25	1	1000	SMAF
1SMAF4732A	4.5	4.7	4.93	53	8	10	1	1000	SMAF
1SMAF4733A	4.84	5.1	5.36	49	7	10	1	1000	SMAF
1SMAF4734A	5.32	5.6	5.92	45	5	10	2	1000	SMAF
1SMAF4735A	5.86	6.2	6.51	41	2	10	3	1000	SMAF
1SMAF4736A	6.46	6.8	7.18	37	3.5	10	4	1000	SMAF
1SMAF4737A	7.12	7.5	7.88	34	4	10	5	1000	SMAF

PARAMETER 參數 TYPE 型號	Zener Voltage Rang			lZT mA	Dynamic Impedance ZzT(@lZT) Max(Ω)	Reverse Current		Power Dissipation Pd mW	Package
	VzT(@lZT)					IR	@VR		
	Min(V)	Nom(V)	Max(V)			Max(μA)	V		
1SMAF4738A	7.79	8.2	8.67	31	4.5	10	6	1000	SMAF
1SMAF4739A	8.6	9.1	9.59	28	5	10	7	1000	SMAF
1SMAF4740A	9.5	10	10.5	25	7	10	7	1000	SMAF
1SMAF4741A	10.4	11	11.6	23	8	5	8	1000	SMAF
1SMAF4742A	11.4	12	12.6	21	9	5	9	1000	SMAF
1SMAF4743A	12.4	13	14.1	19	10	5	10	1000	SMAF
1SMAF4744A	13.8	15	15.8	17	14	5	11	1000	SMAF
1SMAF4745A	15.2	16	17.1	16	16	5	12	1000	SMAF
1SMAF4746A	16.8	18	19.2	14	20	5	13	1000	SMAF
1SMAF4747A	19	20	21.2	13	22	5	15	1000	SMAF
1SMAF4748A	20.8	22	23.3	12	23	5	17	1000	SMAF
1SMAF4749A	22.8	24	26	11	25	5	18	1000	SMAF
1SMAF4750A	25.3	27	28.9	9.5	35	5	21	1000	SMAF
1SMAF4751A	28.2	30	32	8.5	40	5	23	1000	SMAF
1SMAF4752A	31.3	33	34.9	7.5	45	5	25	1000	SMAF
1SMAF4753A	34.2	36	37.9	7	50	5	27	1000	SMAF
1SMAF4754A	37.2	39	41.5	6.5	60	1	30	1000	SMAF
1SMAF4755A	40.9	43	45.6	6	70	1	32	1000	SMAF
1SMAF4756A	44.9	47	49.8	5.5	80	1	35	1000	SMAF
1SMAF4757A	48.6	51	54	5	95	1	38	1000	SMAF
1SMAF4758A	53.6	56	58.8	4.5	110	1	42	1000	SMAF
1SMAF4759A	58.9	62	65.6	4	125	1	47	1000	SMAF
1SMAF4760A	64.6	68	71.7	3.7	150	1	52	1000	SMAF
1SMAF4761A	71.2	75	78.8	3.3	175	1	56	1000	SMAF
1SMAF4762A	77.9	82	87	3	200	1	62	1000	SMAF
1SMAF4763A	86	91	96	2.8	250	1	69	1000	SMAF
1SMAF4764A	95	100	105	2.5	350	1	76	1000	SMAF
1SMAF4765A	104	110	116	2.3	450	1	84	1000	SMAF
1SMAF4766A	114	120	127	2	550	1	91	1000	SMAF
1SMAF4767A	125	135	142	1.9	700	1	100	1000	SMAF
1SMAF4768A	140	150	157	1.7	900	1	110	1000	SMAF
1SMAF4769A	155	165	172	1.6	1100	1	120	1000	SMAF
1SMAF4770A	170	180	191	1.4	1200	1	135	1000	SMAF
1SMAF4771A	189	200	211	1.2	1400	1	150	1000	SMAF
1SMAF4772A	209	220	231	1	1600	1	165	1000	SMAF
1SMAF4773A	229	240	251	1	1800	1	180	1000	SMAF
1SMAF4774A	249	260	271	1	2000	1	190	1000	SMAF
1SMAF4775A	269	280	291	1	2100	1	205	1000	SMAF
1SMAF4776A	289	300	315	1	2300	1	230	1000	SMAF
1SMAF4777A	313	330	346	1	2500	1	250	1000	SMAF
SMBF5913	3.1	3.3	3.5	114	10	100	1	3000	SMBF
SMBF5914	3.4	3.6	3.8	104	9	75	1	3000	SMBF
SMBF5915	3.7	3.9	4.1	96	7.5	25	1	3000	SMBF
SMBF5916	4.06	4.3	4.56	87	6	5	1	3000	SMBF
SMBF5917	4.5	4.7	4.93	80	5	5	1	3000	SMBF
SMBF5918	4.84	5.1	5.36	74	4	5	2	3000	SMBF
SMBF5919	5.32	5.6	5.92	67	2	5	3	3000	SMBF
SMBF5920	5.86	6.2	6.51	61	2	5	4	3000	SMBF
SMBF5921	6.46	6.8	7.18	55	2.5	5	5	3000	SMBF
SMBF5922	7.12	7.5	7.88	50	3	5	6	3000	SMBF
SMBF5923	7.79	8.2	8.67	46	3.5	5	6	3000	SMBF
SMBF5924	8.6	9.1	9.59	41	4	5	7	3000	SMBF
SMBF5925	9.5	10	10.5	38	4.5	5	7	3000	SMBF
SMBF5926	10.4	11	11.6	34	5.5	1	8	3000	SMBF
SMBF5927	11.4	12	12.6	31	6.5	1	9	3000	SMBF
SMBF5928	12.4	13	14.1	29	7	1	10	3000	SMBF

PARAMETER 參數 TYPE 型號	Zener Voltage Rang			IZT mA	Dynamic Impedance ZZT(@IZT) MAX(Ω)	Reverse Current		Power Dissipation Pd mW	Package
	VZT(@IZT)					IR MAX(μA)	@VR V		
	MIN(V)	NOM(V)	MAX(V)						
SMBF5929	13.8	15	15.8	25	9	1	11	3000	SMBF
SMBF5930	15.2	16	17.1	23	10	1	12	3000	SMBF
SMBF5931	16.8	18	19.2	21	12	1	13	3000	SMBF
SMBF5932	19	20	21.2	19	14	1	15	3000	SMBF
SMBF5933	20.8	22	23.3	17	18	1	17	3000	SMBF
SMBF5934	22.8	24	26	16	19	1	18	3000	SMBF
SMBF5935	25.3	27	28.9	14	23	1	21	3000	SMBF
SMBF5936	28.2	30	32	12.5	26	1	23	3000	SMBF
SMBF5937	31.3	33	34.9	11.4	33	1	25	3000	SMBF
SMBF5938	34.2	36	37.9	10.4	38	1	27	3000	SMBF
SMBF5939	37.2	39	41.5	9.6	45	1	30	3000	SMBF
SMBF5940	40.9	43	45.6	8.7	53	1	33	3000	SMBF
SMBF5941	44.9	47	49.8	8	67	1	36	3000	SMBF
SMBF5942	48.6	51	54	7.3	70	1	39	3000	SMBF
SMBF5943	53.6	56	58.8	6.7	86	1	42	3000	SMBF
SMBF5944	58.9	62	65.6	6	100	1	47	3000	SMBF
SMBF5945	64.6	68	71.7	5.5	120	1	52	3000	SMBF
SMBF5946	71.2	75	78.8	5	140	1	57	3000	SMBF
SMBF5947	77.9	82	87	4.6	160	1	62	3000	SMBF
SMBF5948	86	91	96	4.1	200	1	69	3000	SMBF
SMBF5949	95	100	105	3.7	250	1	76	3000	SMBF
SMBF5950	104	110	116	3.4	300	1	84	3000	SMBF
SMBF5951	114	120	127	3.1	380	1	91	3000	SMBF
SMBF5952	125	135	142	2.8	470	1	100	3000	SMBF
SMBF5953	140	150	157	2.5	600	1	110	3000	SMBF
SMBF5954	155	165	172	2.3	720	1	120	3000	SMBF
SMBF5955	170	180	191	2.1	900	1	135	3000	SMBF
SMBF5956	189	200	211	1.9	1200	1	150	3000	SMBF
1SMA4728AG	3.1	3.3	3.5	75	10	100	1	1000	SMA
1SMA4729AG	3.4	3.6	3.8	69	10	100	1	1000	SMA
1SMA4730AG	3.7	3.9	4.1	64	9	50	1	1000	SMA
1SMA4731AG	4.06	4.3	4.56	58	9	25	1	1000	SMA
1SMA4732AG	4.5	4.7	4.93	53	8	10	1	1000	SMA
1SMA4733AG	4.84	5.1	5.36	49	7	10	1	1000	SMA
1SMA4734AG	5.32	5.6	5.92	45	5	10	2	1000	SMA
1SMA4735AG	5.86	6.2	6.51	41	2	10	3	1000	SMA
1SMA4736AG	6.46	6.8	7.18	37	3.5	10	4	1000	SMA
1SMA4737AG	7.12	7.5	7.88	34	4	10	5	1000	SMA
1SMA4738AG	7.79	8.2	8.67	31	4.5	10	6	1000	SMA
1SMA4739AG	8.6	9.1	9.59	28	5	10	7	1000	SMA
1SMA4740AG	9.5	10	10.5	25	7	10	7	1000	SMA
1SMA4741AG	10.4	11	11.6	23	8	5	8	1000	SMA
1SMA4742AG	11.4	12	12.6	21	9	5	9	1000	SMA
1SMA4743AG	12.4	13	14.1	19	10	5	10	1000	SMA
1SMA4744AG	13.8	15	15.8	17	14	5	11	1000	SMA
1SMA4745AG	15.2	16	17.1	16	16	5	12	1000	SMA
1SMA4746AG	16.8	18	19.2	14	20	5	13	1000	SMA
1SMA4747AG	19	20	21.2	13	22	5	15	1000	SMA
1SMA4748AG	20.8	22	23.3	12	23	5	17	1000	SMA
1SMA4749AG	22.8	24	26	11	25	5	18	1000	SMA
1SMA4750AG	25.3	27	28.9	9.5	35	5	21	1000	SMA
1SMA4751AG	28.2	30	32	8.5	40	5	23	1000	SMA
1SMA4752AG	31.3	33	34.9	7.5	45	5	25	1000	SMA
1SMA4753AG	34.2	36	37.9	7	50	5	27	1000	SMA
1SMA4754AG	37.2	39	41.5	6.5	60	5	30	1000	SMA

PARAMETER 參數 TYPE 型號	Zener Voltage Rang			IZT mA	Dynamic Impedance ZZT(@IZT) MAX(Ω)	Reverse Current		Power Dissipation Pd mW	Package
	VZT(@IZT)					IR MAX(μA)	@VR V		
	MIN(V)	NOM(V)	MAX(V)						
1SMA4755AG	40.9	43	45.6	6	70	1	32	1000	SMA
1SMA4756AG	44.9	47	49.8	5.5	80	1	35	1000	SMA
1SMA4757AG	48.6	51	54	5	95	1	38	1000	SMA
1SMA4758AG	53.6	56	58.8	4.5	110	1	42	1000	SMA
1SMA4759AG	58.9	62	65.6	4	125	1	47	1000	SMA
1SMA4760AG	64.6	68	71.7	3.7	150	1	52	1000	SMA
1SMA4761AG	71.2	75	78.8	3.3	175	1	56	1000	SMA
1SMA4762AG	77.9	82	87	3	200	1	62	1000	SMA
1SMA4763AG	86	91	96	2.8	250	1	69	1000	SMA
1SMA4764AG	95	100	105	2.5	350	1	76	1000	SMA
1SMA4765AG	104	110	116	2.3	450	1	84	1000	SMA
1SMA4766AG	114	120	127	2	550	1	91	1000	SMA
1SMA4767AG	125	135	142	1.9	700	1	100	1000	SMA
1SMA4768AG	140	150	157	1.7	900	1	110	1000	SMA
1SMA4769AG	155	165	172	1.6	1100	1	120	1000	SMA
1SMA4770AG	170	180	191	1.4	1200	1	135	1000	SMA
1SMA4771AG	189	200	211	1.2	1400	1	150	1000	SMA
1SMA4772AG	209	220	231	1	1600	1	165	1000	SMA
1SMA4773AG	229	240	251	1	1800	1	180	1000	SMA
1SMA4774AG	249	260	271	1	2000	1	190	1000	SMA
1SMA4775AG	269	280	291	1	2100	1	205	1000	SMA
1SMA4776AG	289	300	315	1	2300	1	230	1000	SMA
1SMA4777AG	313	330	346	1	2500	1	250	1000	SMA
1SMB5913B	3.13	3.3	3.47	113.6	10	100	1	3000	SMB
1SMB5914B	3.42	3.6	3.78	104.2	9	75	1	3000	SMB
1SMB5915B	3.7	3.9	4.1	96.1	7.5	25	1	3000	SMB
1SMB5916B	4.08	4.3	4.52	87.2	6	5	1	3000	SMB
1SMB5917B	4.46	4.7	4.94	79.8	5	5	1.5	3000	SMB
1SMB5918B	4.84	5.1	5.36	73.5	4	5	2	3000	SMB
1SMB5919B	5.32	5.6	5.88	66.9	2	5	3	3000	SMB
1SMB5920B	5.89	6.2	6.51	60.5	2	5	4	3000	SMB
1SMB5921B	6.46	6.8	7.14	55.1	2.5	5	5.2	3000	SMB
1SMB5922B	7.12	7.5	7.88	50	3	5	6	3000	SMB
1SMB5923B	7.79	8.2	8.61	45.7	3.5	5	6.5	3000	SMB
1SMB5924B	8.64	9.1	9.56	41.2	4	5	7	3000	SMB
1SMB5925B	9.5	10	10.5	37.5	4.5	5	8	3000	SMB
1SMB5926B	10.45	11	11.55	34.1	5.5	1	8.4	3000	SMB
1SMB5927B	11.4	12	12.6	31.2	6.5	1	9.1	3000	SMB
1SMB5928B	12.35	13	13.65	28.8	7	1	9.9	3000	SMB
1SMB5929B	14.25	15	15.75	25	9	1	11.4	3000	SMB
1SMB5930B	15.2	16	16.8	23.4	10	1	12.2	3000	SMB
1SMB5931B	17.1	18	18.9	20.8	12	1	13.7	3000	SMB
1SMB5932B	19	20	21	18.7	14	1	15.2	3000	SMB
1SMB5933B	20.9	22	23.1	17	17.5	1	16.7	3000	SMB
1SMB5934B	22.8	24	25.2	15.6	19	1	18.2	3000	SMB
1SMB5935B	25.65	27	28.35	13.9	23	1	20.6	3000	SMB
1SMB5936B	28.5	30	31.5	12.5	26	1	22.8	3000	SMB
1SMB5937B	31.35	33	34.65	11.4	33	1	25.1	3000	SMB
1SMB5938B	34.2	36	37.8	10.4	38	1	27.4	3000	SMB
1SMB5939B	37.05	39	40.95	9.6	45	1	29.7	3000	SMB
1SMB5940B	40.85	43	45.15	8.7	53	1	32.7	3000	SMB
1SMB5941B	44.65	47	49.8	8	67	1	35.8	3000	SMB
1SMB5942B	48.45	51	53.55	7.3	70	1	38.8	3000	SMB
1SMB5943B	53.2	56	58.8	6.7	86	1	42.6	3000	SMB
1SMB5944B	58.9	62	65.1	6	100	1	47.1	3000	SMB
1SMB5945B	64.6	68	71.4	5.5	120	1	51.7	3000	SMB

PARAMETER 參數 TYPE 型號	Zener Voltage Rang			IZT mA	Dynamic Impedance ZZT(@IZT) Max(Ω)	Reverse Current		Power Dissipation Pd mW	Package
	VZT(@IZT)					IR MAX(μA)	@VR V		
	MIN(V)	NOM(V)	MAX(V)						
1SMB5946B	71.25	75	78.75	5	140	1	56	3000	SMB
1SMB5947B	77.9	82	86.1	4.6	160	1	62.2	3000	SMB
1SMB5948B	86.45	91	95.55	4.1	200	1	69.2	3000	SMB
1SMB5949B	95	100	105	3.7	250	1	76	3000	SMB
1SMB5950B	104.5	110	115.5	3.4	300	1	83.6	3000	SMB
1SMB5951B	114	120	126	3.1	380	1	91.2	3000	SMB
1SMB5952B	123.5	130	136.5	2.9	450	1	98.8	3000	SMB
1SMB5953B	142.5	150	157.5	2.5	600	1	114	3000	SMB
1SMB5954B	152	160	168	2.3	700	1	121.6	3000	SMB
1SMB5955B	171	180	189	2.1	900	1	136.8	3000	SMB
1SMB5956B	190	200	210	1.9	1200	1	152	3000	SMB
MM1W3V3	3.1	3.3	3.5	75	10	100	1	1000	SOD-123FL
MM1W3V6	3.4	3.6	3.8	69	10	100	1	1000	SOD-123FL
MM1W3V9	3.7	3.9	4.1	64	9	50	1	1000	SOD-123FL
MM1W4V3	4.06	4.3	4.56	58	9	25	1	1000	SOD-123FL
MM1W4V7	4.5	4.7	4.93	53	8	10	1	1000	SOD-123FL
MM1W5V1	4.84	5.1	5.36	49	7	10	1	1000	SOD-123FL
MM1W5V6	5.32	5.6	5.92	45	5	10	2	1000	SOD-123FL
MM1W6V2	5.86	6.2	6.51	41	2	10	3	1000	SOD-123FL
MM1W6V8	6.46	6.8	7.18	37	3.5	10	4	1000	SOD-123FL
MM1W7V5	7.12	7.5	7.88	34	4	10	5	1000	SOD-123FL
MM1W8V2	7.79	8.2	8.67	31	4.5	10	6	1000	SOD-123FL
MM1W9V1	8.6	9.1	9.59	28	5	10	7	1000	SOD-123FL
MM1W10	9.5	10	10.5	25	7	10	7	1000	SOD-123FL
MM1W11	10.4	11	11.6	23	8	5	8	1000	SOD-123FL
MM1W12	11.4	12	12.6	21	9	5	9	1000	SOD-123FL
MM1W13	12.4	13	14.1	19	10	5	10	1000	SOD-123FL
MM1W15	13.8	15	15.8	17	14	5	11	1000	SOD-123FL
MM1W16	15.2	16	17.1	16	16	5	12	1000	SOD-123FL
MM1W18	16.8	18	19.2	14	20	5	13	1000	SOD-123FL
MM1W20	19	20	21.2	13	22	5	15	1000	SOD-123FL
MM1W22	20.8	22	23.3	12	23	5	17	1000	SOD-123FL
MM1W24	22.8	24	26	11	25	5	18	1000	SOD-123FL
MM1W27	25.3	27	28.9	9.5	35	5	21	1000	SOD-123FL
MM1W30	28.2	30	32	8.5	40	5	23	1000	SOD-123FL
MM1W33	31.3	33	34.9	7.5	45	5	25	1000	SOD-123FL
MM1W36	34.2	36	37.9	7	50	5	27	1000	SOD-123FL
MM1W39	37.2	39	41.5	6.5	60	5	30	1000	SOD-123FL
MM1W43	40.9	43	45.6	6	70	1	32	1000	SOD-123FL
MM1W47	44.9	47	49.8	5.5	80	1	35	1000	SOD-123FL
MM1W51	48.6	51	54	5	95	1	38	1000	SOD-123FL
MM1W56	53.6	56	58.8	4.5	110	1	42	1000	SOD-123FL
MM1W62	58.9	62	65.6	4	125	1	47	1000	SOD-123FL
MM1W68	64.6	68	71.7	3.7	150	1	52	1000	SOD-123FL
MM1W75	71.2	75	78.8	3.3	175	1	56	1000	SOD-123FL
MM1W82	77.9	82	87	3	200	1	62	1000	SOD-123FL
MM1W91	86	91	96	2.8	250	1	69	1000	SOD-123FL
MM1W100	95	100	105	2.5	350	1	76	1000	SOD-123FL
MM1W110	104	110	116	2.3	450	1	84	1000	SOD-123FL
MM1W120	114	120	127	2	550	1	91	1000	SOD-123FL
MM1W135	125	135	142	1.9	700	1	100	1000	SOD-123FL
MM1W150	140	150	157	1.7	900	1	110	1000	SOD-123FL
MM1W165	155	165	172	1.6	1100	1	120	1000	SOD-123FL
MM1W180	170	180	191	1.4	1200	1	135	1000	SOD-123FL
MM1W200	189	200	211	1.2	1400	1	150	1000	SOD-123FL
MM1W220	209	220	231	1	1600	1	165	1000	SOD-123FL

PARAMETER 參數 TYPE 型號	Zener Voltage Rang			I _{ZT} mA	Dynamic Impedance Z _{ZT} (@I _{ZT}) MAX(Ω)	Reverse Current		Power Dissipation P _D mW	Package
	V _{ZT} (@I _{ZT})					I _R MAX(μA)	@V _R V		
	MIN(V)	NOM(V)	MAX(V)						
MM1W240	229	240	251	1	1800	1	180	1000	SOD-123FL
MM1W260	249	260	271	1	2000	1	190	1000	SOD-123FL
MM1W280	269	280	291	1	2100	1	205	1000	SOD-123FL
MM1W300	289	300	315	1	2300	1	230	1000	SOD-123FL
MM1W330	313	330	346	1	2500	1	250	1000	SOD-123FL
BZT52B2V4	2.35	2.4	2.45	5	100	50	1	500	SOD-123
BZT52B2V7	2.65	2.7	2.75	5	100	20	1	500	SOD-123
BZT52B3V0	2.94	3	3.06	5	95	10	1	500	SOD-123
BZT52B3V3	3.23	3.3	3.37	5	95	5	1	500	SOD-123
BZT52B3V6	3.53	3.6	3.67	5	90	5	1	500	SOD-123
BZT52B3V9	3.82	3.9	3.98	5	90	3	1	500	SOD-123
BZT52B4V3	4.21	4.3	4.39	5	90	3	1	500	SOD-123
BZT52B4V7	4.61	4.7	4.79	5	80	3	2	500	SOD-123
BZT52B5V1	5	5.1	5.2	5	60	2	2	500	SOD-123
BZT52B5V6	5.49	5.6	5.71	5	40	1	2	500	SOD-123
BZT52B6V2	6.08	6.2	6.32	5	10	3	4	500	SOD-123
BZT52B6V8	6.66	6.8	6.94	5	15	2	4	500	SOD-123
BZT52B7V5	7.35	7.5	7.65	5	15	1	5	500	SOD-123
BZT52B8V2	8.04	8.2	8.36	5	15	0.7	5	500	SOD-123
BZT52B9V1	8.92	9.1	9.28	5	15	0.5	6	500	SOD-123
BZT52B10	9.8	10	10.2	5	20	0.2	7	500	SOD-123
BZT52B11	10.78	11	11.22	5	20	0.1	8	500	SOD-123
BZT52B12	11.76	12	12.24	5	25	0.1	8	500	SOD-123
BZT52B13	12.74	13	13.26	5	30	0.1	8	500	SOD-123
BZT52B15	14.7	15	15.3	5	30	0.1	10.5	500	SOD-123
BZT52B16	15.68	16	16.32	5	40	0.1	11.2	500	SOD-123
BZT52B18	17.64	18	18.36	5	45	0.1	12.6	500	SOD-123
BZT52B20	19.6	20	20.4	5	55	0.1	14	500	SOD-123
BZT52B22	21.56	22	22.44	5	55	0.1	15.4	500	SOD-123
BZT52B24	23.52	24	24.48	5	70	0.1	16.8	500	SOD-123
BZT52B27	26.46	27	27.54	2	80	0.1	18.9	500	SOD-123
BZT52B30	29.4	30	30.6	2	80	0.1	21	500	SOD-123
BZT52B33	32.34	33	33.66	2	80	0.1	23.1	500	SOD-123
BZT52B36	35.28	36	36.72	2	90	0.1	25.2	500	SOD-123
BZT52B39	38.22	39	39.78	2	130	0.1	27.3	500	SOD-123
BZT52B43	41.16	43	42.84	2	130	0.1	29.4	500	SOD-123
BZT52C2V0	1.8	2	2.15	5	100	120	0.5	500	SOD-123
BZT52C2V2	2.08	2.2	2.33	5	100	120	0.7	500	SOD-123
BZT52C2V4	2.28	2.4	2.56	5	100	120	1	500	SOD-123
BZT52C2V7	2.5	2.7	2.9	5	110	120	1	500	SOD-123
BZT52C3V0	2.8	3	3.2	5	120	50	1	500	SOD-123
BZT52C3V3	3.1	3.3	3.5	5	130	20	1	500	SOD-123
BZT52C3V6	3.4	3.6	3.8	5	130	10	1	500	SOD-123
BZT52C3V9	3.7	3.9	4.1	5	130	5	1	500	SOD-123
BZT52C4V3	4	4.3	4.6	5	130	5	1	500	SOD-123
BZT52C4V7	4.4	4.7	5	5	130	2	1	500	SOD-123
BZT52C5V1	4.8	5.1	5.4	5	130	2	1.5	500	SOD-123
BZT52C5V6	5.2	5.6	6	5	80	1	2.5	500	SOD-123
BZT52C6V2	5.8	6.2	6.6	5	50	1	3	500	SOD-123
BZT52C6V8	6.4	6.8	7.2	5	30	0.5	3.5	500	SOD-123
BZT52C7V5	7	7.5	7.9	5	30	0.5	4	500	SOD-123
BZT52C8V2	7.7	8.2	8.7	5	30	0.5	5	500	SOD-123
BZT52C9V1	8.5	9.1	9.6	5	30	0.5	6	500	SOD-123
BZT52C10	9.4	10	10.6	5	30	0.1	7	500	SOD-123
BZT52C11	10.4	11	11.6	5	30	0.1	8	500	SOD-123
BZT52C12	11.4	12	12.7	5	35	0.1	9	500	SOD-123

PARAMETER 參數 TYPE 型號	Zener Voltage Rang			IZT mA	Dynamic Impedance Zzt(@IZT) MAX(Ω)	Reverse Current		Power Dissipation Pd mW	Package
	Vzt(@IZT)					IR MAX(μA)	@Vr V		
	MIN(V)	NOM(V)	MAX(V)						
BZT52C13	12.4	13	14.1	5	35	0.1	10	500	SOD-123
BZT52C15	13.8	15	15.6	5	40	0.1	11	500	SOD-123
BZT52C16	15.3	16	17.1	5	40	0.1	12	500	SOD-123
BZT52C18	16.8	18	19.1	5	45	0.1	13	500	SOD-123
BZT52C20	18.8	20	21.2	5	50	0.1	15	500	SOD-123
BZT52C22	20.8	22	23.3	5	55	0.1	17	500	SOD-123
BZT52C24	22.8	24	25.6	5	60	0.1	19	500	SOD-123
BZT52C27	25.1	27	28.9	5	70	0.1	21	500	SOD-123
BZT52C30	28	30	32	5	80	0.1	23	500	SOD-123
BZT52C33	31	33	35	5	80	0.1	25	500	SOD-123
BZT52C36	34	36	38	5	90	0.1	27	500	SOD-123
BZT52C39	37	39	41	2.5	100	2	30	500	SOD-123
BZT52C43	40	43	46	2.5	130	2	33	500	SOD-123
BZT52C47	44	47	50	2.5	150	2	36	500	SOD-123
BZT52C51	48	51	54	2.5	180	1	39	500	SOD-123
BZT52C56	52	56	60	2.5	180	1	43	500	SOD-123
BZT52C62	58	62	66	2.5	200	0.2	47	500	SOD-123
BZT52C68	64	68	72	2.5	250	0.2	52	500	SOD-123
BZT52C75	70	75	79	2.5	300	0.2	57	500	SOD-123
MM3Z2V0	1.8	2	2.15	5	100	120	0.5	200	SOD-323
MM3Z2V2	2.08	2.2	2.33	5	100	120	0.7	200	SOD-323
MM3Z2V4	2.28	2.4	2.56	5	100	120	1	200	SOD-323
MM3Z2V7	2.5	2.7	2.9	5	110	120	1	200	SOD-323
MM3Z3V0	2.8	3	3.2	5	120	50	1	200	SOD-323
MM3Z3V3	3.1	3.3	3.5	5	130	20	1	200	SOD-323
MM3Z3V6	3.4	3.6	3.8	5	130	10	1	200	SOD-323
MM3Z3V9	3.7	3.9	4.1	5	130	5	1	200	SOD-323
MM3Z4V3	4	4.3	4.6	5	130	5	1	200	SOD-323
MM3Z4V7	4.4	4.7	5	5	130	2	1	200	SOD-323
MM3Z5V1	4.8	5.1	5.4	5	130	2	1.5	200	SOD-323
MM3Z5V6	5.2	5.6	6	5	80	1	2.5	200	SOD-323
MM3Z6V2	5.8	6.2	6.6	5	50	1	3	200	SOD-323
MM3Z6V8	6.4	6.8	7.2	5	30	0.5	3.5	200	SOD-323
MM3Z7V5	7	7.5	7.9	5	30	0.5	4	200	SOD-323
MM3Z8V2	7.7	8.2	8.7	5	30	0.5	5	200	SOD-323
MM3Z9V1	8.5	9.1	9.6	5	30	0.5	6	200	SOD-323
MM3Z10V	9.4	10	10.6	5	30	0.1	7	200	SOD-323
MM3Z11V	10.4	11	11.6	5	30	0.1	8	200	SOD-323
MM3Z12V	11.4	12	12.7	5	35	0.1	9	200	SOD-323
MM3Z13V	12.4	13	14.1	5	35	0.1	10	200	SOD-323
MM3Z15V	13.8	15	15.6	5	40	0.1	11	200	SOD-323
MM3Z16V	15.3	16	17.1	5	40	0.1	12	200	SOD-323
MM3Z18V	16.8	18	19.1	5	45	0.1	13	200	SOD-323
MM3Z20V	18.8	20	21.2	5	50	0.1	15	200	SOD-323
MM3Z22V	20.8	22	23.3	5	55	0.1	17	200	SOD-323
MM3Z24V	22.8	24	25.6	5	60	0.1	19	200	SOD-323
MM3Z27V	25.1	27	28.9	2	70	0.1	21	200	SOD-323
MM3Z30V	28	30	32	2	80	0.1	23	200	SOD-323
MM3Z33V	31	33	35	2	80	0.1	25	200	SOD-323
MM3Z36V	34	36	38	2	90	0.1	27	200	SOD-323
MM3Z39V	37	39	41	2	100	0.1	30	200	SOD-323
MM3Z43V	40	43	46	2	130	0.1	33	200	SOD-323
MM3Z47V	44	47	50	2	150	0.1	36	200	SOD-323
MM3Z51V	48	51	54	2	180	0.1	39	200	SOD-323
MM3Z56V	52	56	60	2	200	0.1	43	200	SOD-323
MM3Z62V	58	62	66	2	215	0.1	47	200	SOD-323

PARAMETER 參數 TYPE 型號	Zener Voltage Rang			I _{ZT} mA	Dynamic Impedance Z _{ZT} (@I _{ZT}) Max(Ω)	Reverse Current		Power Dissipation P _D mW	Package
	V _{ZT} (@I _{ZT})					I _R Max(μA)	@V _R V		
	Min(V)	Nom(V)	Max(V)						
MM3Z68V	64	68	72	2	240	0.1	52	200	SOD-323
MM3Z75V	70	75	79	2	265	0.1	56	200	SOD-323
MM5Z2V4	2.2	2.4	2.6	5	100	50	1	150	SOD-523
MM5Z2V7	2.5	2.7	2.9	5	100	20	1	150	SOD-523
MM5Z3V0	2.8	3	3.2	5	100	10	1	150	SOD-523
MM5Z3V3	3.1	3.3	3.5	5	95	5	1	150	SOD-523
MM5Z3V6	3.4	3.6	3.8	5	90	5	1	150	SOD-523
MM5Z3V9	3.7	3.9	4.1	5	90	3	1	150	SOD-523
MM5Z4V3	4	4.3	4.6	5	90	3	1	150	SOD-523
MM5Z4V7	4.4	4.7	5	5	80	3	2	150	SOD-523
MM5Z5V1	4.8	5.1	5.4	5	60	2	2	150	SOD-523
MM5Z5V6	5.2	5.6	6	5	40	1	2	150	SOD-523
MM5Z6V2	5.8	6.2	6.6	5	10	3	4	150	SOD-523
MM5Z6V8	6.4	6.8	7.2	5	15	2	4	150	SOD-523
MM5Z7V5	7	7.5	7.9	5	15	1	5	150	SOD-523
MM5Z8V2	7.7	8.2	8.7	5	15	0.7	5	150	SOD-523
MM5Z9V1	8.5	9.1	9.6	5	15	0.2	7	150	SOD-523
MM5Z10V	9.4	10	10.6	5	20	0.1	8	150	SOD-523
MM5Z11V	10.4	11	11.6	5	20	0.1	8	150	SOD-523
MM5Z12V	11.4	12	12.7	5	25	0.1	8	150	SOD-523
MM5Z13V	12.4	13.25	14.1	5	30	0.1	8	150	SOD-523
MM5Z15V	14.3	15	15.8	5	30	0.05	10.5	150	SOD-523
MM5Z16V	15.3	16.2	17.1	5	40	0.05	11.2	150	SOD-523
MM5Z18V	16.8	18	19.1	5	45	0.05	12.6	150	SOD-523
MM5Z20V	18.8	20	21.2	5	55	0.05	14	150	SOD-523
MM5Z22V	20.8	22	23.3	2	55	0.05	15.4	150	SOD-523
MM5Z24V	22.8	24.2	25.6	2	70	0.05	16.8	150	SOD-523
MM5Z27V	25.1	27	28.9	2	80	0.05	18.9	150	SOD-523
MM5Z30V	28	30	32	2	80	0.05	21	150	SOD-523
MM5Z33V	31	33	35	2	80	0.05	23.2	150	SOD-523
MM5Z36V	34	36	38	2	90	0.05	25.5	150	SOD-523
MM5Z39V	37	39	41	2	130	0.05	27.3	150	SOD-523
MM5Z43V	40	43	46	1	150	0.05	30.1	150	SOD-523
MM5Z47V	44	47	50	1	170	0.05	32.9	150	SOD-523
MM5Z51V	48	51	54	1	180	0.05	35.7	150	SOD-523
MM5Z56V	52	56	60	1	200	0.05	39.2	150	SOD-523
MM5Z62V	58	62	66	1	215	0.05	43.4	150	SOD-523
MM5Z68V	64	68	72	1	240	0.05	47.6	150	SOD-523
MM5Z75V	70	75	79	1	255	0.05	52.5	150	SOD-523
MM5Z2V2B	2.1	2.2	2.4	5	100	120	0.7	150	SOD-523
MM5Z2V4B	2.4	2.4	2.65	5	100	120	1	200	SOD-523
MM5Z2V7B	2.65	2.7	2.95	5	110	120	1	200	SOD-523
MM5Z3V0B	2.95	3	3.25	5	120	50	1	200	SOD-523
MM5Z3V3B	3.25	3.3	3.55	5	120	20	1	200	SOD-523
MM5Z3V6B	3.6	3.6	3.845	5	100	10	1	200	SOD-523
MM5Z3V9B	3.89	3.9	4.16	5	100	5	1	200	SOD-523
MM5Z4V3B	4.17	4.3	4.43	5	100	5	1	200	SOD-523
MM5Z4V7B	4.55	4.7	4.75	5	100	2	1	200	SOD-523
MM5Z5V1B	4.98	5.1	5.2	5	80	2	1.5	200	SOD-523
MM5Z5V6B	5.49	5.6	5.73	5	60	1	2.5	200	SOD-523
MM5Z6V2B	6.06	6.2	6.33	5	60	1	3	200	SOD-523
MM5Z6V8B	6.65	6.8	6.93	5	40	0.5	3.5	200	SOD-523
MM5Z7V5B	7.28	7.5	7.6	5	30	0.5	4	200	SOD-523
MM5Z8V2B	8.02	8.2	8.36	5	30	0.5	5	200	SOD-523
MM5Z9V1B	8.85	9.1	9.23	5	30	0.5	6	200	SOD-523
MM5Z10B	9.77	10	10.21	5	30	0	7	200	SOD-523

PARAMETER 參數 TYPE 型號	Zener Voltage Rang			IZT mA	Dynamic Impedance ZZT(@IZT) MAX(Ω)	Reverse Current		Power Dissipation Pd mW	Package
	VZT(@IZT)					IR MAX(μA)	@VR V		
	MIN(V)	NOM(V)	MAX(V)						
MM5Z11B	10.76	11	11.22	5	30	0.1	8	200	SOD-523
MM5Z12B	11.74	12	12.24	5	30	0.1	9	200	SOD-523
MM5Z13B	12.91	13	13.49	5	37	0.1	10	200	SOD-523
MM5Z15B	14.34	15	14.98	5	42	0.1	11	200	SOD-523
MM5Z16B	15.85	16	16.51	5	50	0.1	12	200	SOD-523
MM5Z18B	15.85	18	16.51	5	65	0.1	13	200	SOD-523
MM5Z20B	19.52	20	20.39	5	85	0.1	15	200	SOD-523
MM5Z22B	21.54	22	22.47	5	100	0.1	17	200	SOD-523
MM5Z24B	23.72	24	24.78	5	120	0.1	19	200	SOD-523
MM5Z27B	26.19	27	27.53	5	150	0.1	21	200	SOD-523
MM5Z30B	29.19	30	30.69	5	200	0.1	23	200	SOD-523
MM5Z33B	32.15	33	33.79	5	250	0.1	25	200	SOD-523
MM5Z36B	35.07	36	36.87	5	300	0.1	27	200	SOD-523
MM5Z39B	37	39	41	5	100	2	30	200	SOD-523

PARAMETER 參數 TYPE 型號	PIN ARRAY	Zener Voltage Range			@IZT mA	Dynamic Impedance ZZT MAX(Ω)	Reverse Current		Power Dissipation Pd mW	Package
		VZT					IR MAX(μA)	@VR V		
		MIN(V)	NOM(V)	MAX(V)						
BZX84C2V4	壹陽三陰	2.2	2.4	2.6	5	100	50	1	225	SOT-23
BZX84C2V7	壹陽三陰	2.5	2.7	2.9	5	100	20	1	225	SOT-23
BZX84C3V0	壹陽三陰	2.8	3	3.2	5	95	10	1	225	SOT-23
BZX84C3V3	壹陽三陰	3.1	3.3	3.5	5	95	5	1	225	SOT-23
BZX84C3V6	壹陽三陰	3.4	3.6	3.8	5	90	5	1	225	SOT-23
BZX84C3V9	壹陽三陰	3.7	3.9	4.1	5	90	3	1	225	SOT-23
BZX84C4V3	壹陽三陰	4	4.3	4.6	5	90	3	1	225	SOT-23
BZX84C4V7	壹陽三陰	4.4	4.7	5	5	80	3	2	225	SOT-23
BZX84C5V1	壹陽三陰	4.8	5.1	5.4	5	60	2	2	225	SOT-23
BZX84C5V6	壹陽三陰	5.2	5.6	6	5	40	1	2	225	SOT-23
BZX84C6V2	壹陽三陰	5.8	6.2	6.6	5	10	3	4	225	SOT-23
BZX84C6V8	壹陽三陰	6.4	6.8	7.2	5	15	2	4	225	SOT-23
BZX84C7V5	壹陽三陰	7	7.5	7.9	5	15	1	5	225	SOT-23
BZX84C8V2	壹陽三陰	7.7	8.2	8.7	5	15	0.7	5	225	SOT-23
BZX84C9V1	壹陽三陰	8.5	9.1	9.6	5	15	0.5	6	225	SOT-23
BZX84C10	壹陽三陰	9.4	10	10.6	5	20	0.2	7	225	SOT-23
BZX84C11	壹陽三陰	10.4	11	11.6	5	20	0.1	8	225	SOT-23
BZX84C12	壹陽三陰	11.4	12	12.7	5	25	0.1	8	225	SOT-23
BZX84C13	壹陽三陰	12.4	13	14.1	5	30	0.1	8	225	SOT-23
BZX84C15	壹陽三陰	13.8	15	15.6	5	30	0.05	10.5	225	SOT-23
BZX84C16	壹陽三陰	15.3	16	17.1	5	40	0.05	11.2	225	SOT-23
BZX84C18	壹陽三陰	16.8	18	19.1	5	45	0.05	12.6	225	SOT-23
BZX84C20	壹陽三陰	18.8	20	21.2	5	55	0.05	14	225	SOT-23
BZX84C22	壹陽三陰	20.8	22	23.3	5	55	0.05	15.4	225	SOT-23
BZX84C24	壹陽三陰	22.8	24	25.6	5	70	0.05	16.8	225	SOT-23
BZX84C27	壹陽三陰	25.1	27	28.9	5	80	0.05	18.9	225	SOT-23
BZX84C30	壹陽三陰	28	30	32	5	80	0.05	21	225	SOT-23
BZX84C33	壹陽三陰	31	33	35	5	80	0.05	23.1	225	SOT-23
BZX84C36	壹陽三陰	34	36	38	5	90	0.05	25.5	225	SOT-23
BZX84C39	壹陽三陰	37	39	41	5	130	0.05	27.3	225	SOT-23
BZX84C43	壹陽三陰	40	43	46	5	150	0.05	30.1	225	SOT-23
BZX84C47	壹陽三陰	44	47	50	5	170	0.05	32.9	225	SOT-23
BZX84C51	壹陽三陰	48	51	54	5	180	0.05	35.7	225	SOT-23
BZX84C56	壹陽三陰	52	56	60	5	200	0.05	39.2	225	SOT-23
BZX84C62	壹陽三陰	58	62	66	5	215	0.05	43.4	225	SOT-23
BZX84C68	壹陽三陰	64	68	72	5	240	0.05	47.6	225	SOT-23
BZX84C75	壹陽三陰	70	75	79	5	255	0.05	52.5	225	SOT-23

PARAMETER TYPE 參數 型號	PIN ARRAY	Zener Voltage Range			@I _{ZT} mA	Dynamic Impedance Z _{ZT} MAX(Ω)	Reverse Current		Power Dissipation P _D mW	Package
		V _{ZT}					I _R MAX(μA)	@V _R V		
		MIN(V)	NOM(V)	MAX(V)						
MMBZ5221B	壹陽三陰	2.28	2.4	2.52	20	30	100	1	225	SOT-23
MMBZ5223B	壹陽三陰	2.57	2.7	2.84	20	30	75	1	225	SOT-23
MMBZ5225B	壹陽三陰	2.85	3	3.15	20	30	50	1	225	SOT-23
MMBZ5226B	壹陽三陰	3.14	3.3	3.47	20	28	25	1	225	SOT-23
MMBZ5227B	壹陽三陰	3.42	3.6	3.78	20	24	15	1	225	SOT-23
MMBZ5228B	壹陽三陰	3.71	3.9	4.1	20	23	10	1	225	SOT-23
MMBZ5229B	壹陽三陰	4.09	4.3	4.52	20	22	5	1	225	SOT-23
MMBZ5230B	壹陽三陰	4.47	4.7	4.94	20	19	5	2	225	SOT-23
MMBZ5231B	壹陽三陰	4.85	5.1	5.36	20	17	5	2	225	SOT-23
MMBZ5232B	壹陽三陰	5.32	5.6	5.88	20	11	5	2	225	SOT-23
MMBZ5233B	壹陽三陰	5.7	6	6.3	20	7	5	3.5	225	SOT-23
MMBZ5234B	壹陽三陰	5.89	6.2	6.51	20	7	5	4	225	SOT-23
MMBZ5235B	壹陽三陰	6.46	6.8	7.14	20	5	3	5	225	SOT-23
MMBZ5236B	壹陽三陰	7.13	7.5	7.88	20	6	3	6	225	SOT-23
MMBZ5237B	壹陽三陰	7.79	8.2	8.61	20	8	3	6.2	225	SOT-23
MMBZ5238B	壹陽三陰	8.27	8.7	9.14	20	8	3	6.5	225	SOT-23
MMBZ5239B	壹陽三陰	8.65	9.1	9.56	20	10	3	7	225	SOT-23
MMBZ5240B	壹陽三陰	9.5	10	10.5	20	17	3	8	225	SOT-23
MMBZ5241B	壹陽三陰	10.45	11	11.55	20	22	2	8.4	225	SOT-23
MMBZ5242B	壹陽三陰	11.4	12	12.6	20	30	1	9.1	225	SOT-23
MMBZ5243B	壹陽三陰	12.35	13	13.65	9.5	13	0.5	9.9	225	SOT-23
MMBZ5245B	壹陽三陰	14.25	15	15.75	8.5	16	0.1	11	225	SOT-23
MMBZ5246B	壹陽三陰	15.2	16	16.8	7.8	17	0.1	12	225	SOT-23
MMBZ5250B	壹陽三陰	19	20	21	6.2	25	0.1	15	225	SOT-23
MMBZ5251B	壹陽三陰	20.9	22	23.1	5.6	29	0.1	17	225	SOT-23
MMBZ5252B	壹陽三陰	22.8	24	25.2	5.2	33	0.1	18	225	SOT-23
MMBZ5254B	壹陽三陰	25.65	27	28.35	5	41	0.1	21	225	SOT-23
MMBZ5255B	壹陽三陰	26.6	28	29.4	4.5	44	0.1	21	225	SOT-23
MMBZ5256B	壹陽三陰	28.5	30	31.5	4.2	49	0.1	23	225	SOT-23
MMBZ5257B	壹陽三陰	31.35	33	34.65	3.8	58	0.1	25	225	SOT-23
MMBZ5258B	壹陽三陰	34.2	36	37.8	3	70	0.1	27	225	SOT-23
MMBZ5259B	壹陽三陰	37.05	39	40.95	32	80	0.1	30	225	SOT-23

ZENER DIODES TWO CHIP

穩壓管 (雙芯片)

PARAMETER TYPE 參數 型號	PD	腳位	V _{RWM}	I _{R@V_{RWM}}	V _{BR@I_{MA}}	Package
	mW	PIN ARRAY	V	μA	V	
MMBZ5V6A	300	共陽三陽	3	5	5.32-5.88	SOT-23
MMBZ6V2A	300	共陽三陽	3	0.5	5.89-6.51	SOT-23
MMBZ6V8A	300	共陽三陽	4.5	0.5	6.46-7.14	SOT-23
MMBZ9V1A	300	共陽三陽	6	0.3	8.65-9.56	SOT-23
MMBZ10VA	300	共陽三陽	6.5	0.3	9.5-10.5	SOT-23
MMBZ12VA	300	共陽三陽	8.5	0.2	11.4-12.6	SOT-23
MMBZ15VA	300	共陽三陽	12	0.05	14.25-15.75	SOT-23
MMBZ18VA	300	共陽三陽	14.5	0.05	17.1-18.9	SOT-23
MMBZ20VA	300	共陽三陽	17	0.05	19-21	SOT-23
MMBZ27VA	300	共陽三陽	22	0.05	25.65-28.35	SOT-23
MMBZ33VA	300	共陽三陽	26	0.05	31.35-34.65	SOT-23

BI-DIRECTIONAL TRIGGER DIODES

雙向觸發二極管

TYPE 型號	PARAMETER 參數	V _{Bo} @22NF	+/-V _{Bo}	ΔV	V _o	I _{Bo}	I _B	T _{RR}	Package
		V	V	V	V	μA	μA	μS	
DB3T		28	3	5	5	50	10	2	SOD-123
DC34T		30	3	5	5	50	10	2	SOD-123
DB4T		35	3	5	5	50	10	2	SOD-123
LLDB3		28	3	5	5	100	10		SOD-80

SWITCH DIODES

開關二極管

TYPE 型號	PARAMETER 參數	PD	V _{RRM}	I _o	I _F	V _F		I _R		T _{RR}	Package		
						mW	V	mA	mA				
												V	I _F
BAV19WL		500	120		250	1	100	0.1	120	50	SOD-123FL		
BAV20WL		500	200		250	1	100	0.1	150	50	SOD-123FL		
BAV21WL		500	250		250	1	100	0.1	200	50	SOD-123FL		
BAV100		500	60		250	1	100	0.1	50	50	SOD-80		
BAV101		500	120		250	1	100	0.1	100	50	SOD-80		
BAV102		500	200		250	1	100	0.1	150	50	SOD-80		
BAV103		500	250		250	1	100	0.1	200	50	SOD-80		
LL4148		500	100		200	1	20	5	75	4	SOD-80		
MMSD914		350	75	150		1	50	2.5	75	4	SOD-123		
BAV16W		400	75	150	300	1.25	150	1	75	4	SOD-123		
1N4148W		400	100	150	300	1.25	150	1	75	8	SOD-123		
1N4448W		350	100	250	500	1.25	150	2.5	75	4	SOD-123		
BAV19W		250	100	200	400	1.25	200	0.1	100	50	SOD-123		
BAV20W		250	150	200	400	1.25	200	0.1	150	50	SOD-123		
BAV21W		250	200	200	400	1.25	200	0.1	200	50	SOD-123		
KDS160		200	85		150	1	50	1	75	4	SOD-323		
BAV19WS		200	150		200	1.25	200	0.1	100	50	SOD-323		
BAV20WS		200	200		200	1.25	200	0.1	150	50	SOD-323		
BAV21WS		200	250		200	1.25	200	0.1	200	50	SOD-323		
1SS355		200	80	150	250	1.2	100	0.1	80	4	SOD-323		
BAV16WS		200	75	150	300	1.25	150	1	75	4	SOD-323		
BAS316			100		300	1.1	150	1	50	6	SOD-323		
1N4148WS		200	100	150	300	1.25	150	1	75	8	SOD-323		
BAS321		200	250	200	400	1	100	100	200	50	SOD-323		
1N4448WS		200	100	250	500	1.25	150	2.5	75	4	SOD-323		
BAR64-02		150	150		100	1.1	50	10	150		SOD-523		
BAV19WT		200	120		200	1	100	0.1	100	50	SOD-523		
BAV20WT		200	200		200	1	100	0.1	150	50	SOD-523		
BAV21WT		200	250		200	1	100	0.1	200	50	SOD-523		
1N4148WT		150	80		250	1.25	100		75	4	SOD-523		
1SS400		150	80		225	1.2	100	20	80	4	SOD-523		
KDS160E		150	90		225	1.2	100	20	80	4	SOD-523		
BAS516		150	90		225	1.2	100	20	80	4	SOD-523		
BAS716		150	90		225	1.2	100	20	80	4	SOD-523		
1SS400G			90	100	225	1.2	100	0.1	80	4	SOD-723		

PARAMETER 參數 TYPE 型號	PD mW	PIN ARRAY	V _{RRM} V	I _o mA	I _F mA	V _F		I _R		T _{RR} NS	Package
						V	I _f mA	μA	V _R V		
1SS181	150	共陽三陽	80		100	1.2	100	0.5	80	4	SOT-23
1SS184	150	共陰三陽	80		100	1.2	100	0.5	80	4	SOT-23
1SS187	150	壹陰三陽	80		100	1.2	100	0.5	80	4	SOT-23
1SS190	150	二陰三陽	80		100	1.2	100	0.5	80	4	SOT-23
1SS193	150	壹陽三陰	80		100	1.2	100	0.5	80	4	SOT-23
1SS196	150	二陽三陰	80		100	1.2	100	0.5	80	4	SOT-23
1SS226	150	串聯壹陽	80		100	1.2	100	0.5	80	4	SOT-23
MMBD2836	150	共陽三陽	50		100	1.2	100	0.1	50	4	SOT-23
BAL99	225	二陰三陽	70		100	1.25	150	2.5	70	6	SOT-23
BAS116	225	壹陽三陰	75		200	1.25	150	5	75	3000	SOT-23
BAS16	225	壹陽三陰	75		200	1.25	200	1	75	6	SOT-23
BAS19	250	壹陽三陰	100		200	1	100	0.1	100	50	SOT-23
BAS21	225	壹陽三陰	250		200	1.25	200	1	200	50	SOT-23
BAS21C	225	共陽三陰	250		200	1.25	200	1	200	50	SOT-23
BAS21S	225	串聯壹陽	250		200	1.25	200	1	200	50	SOT-23
BAW56	225	共陰三陽	70		200	1.25	150	2.5	70	6	SOT-23
BAV70	225	共陰三陽	70		200	1.25	150	2.5	70	6	SOT-23
BAV74	225	共陰三陽	50		200	1	100	0.1	50	4	SOT-23
MMBD914	225	壹陽三陰	75		200	1.25	150	2.5	75	4	SOT-23
MMBD7000	225	串聯壹陽	100		200	1.1	100	3	100	4	SOT-23
MMBD4148CA	350	共陽三陽	100		200	1	10	5	75	4	SOT-23
MMBD4148CC	350	共陰三陽	100		200	1	10	5	75	4	SOT-23
MMBD4148SE	350	串聯壹陽	100		200	1	10	5	75	4	SOT-23
BAV99	225	串聯壹陽	70		215	1.25	150	2.5	70	6	SOT-23
BAV199	300	串聯壹陽	70		215	1.25	150	5	70	3000	SOT-23
MMBD1203	300	串聯壹陽	70		250	1	50	2.5	70	6	SOT-23
MMBD2838	150	共陽三陰	50		300	1.2	100	0.1	50	3	SOT-23
MMBD1501A	350	壹陽三陰	200		300	1.5	300	0.01	180		SOT-23
MMBD4148	350	壹陽三陰	75		600	1.25	150	2.5	75	4	SOT-23
MMBD1503A	350	串聯壹陽	200		600	1.5	300	0.01	180		SOT-23
MMBD1504A	350	共陽三陰	200		600	1.5	300	0.01	180		SOT-23
BAW56W	200	共陽三陽	70		200	1	60	2.5	70	6	SOT-323
CMSD2004S	250	串聯壹陽	300	200	225	1	100	0.1	240	50	SOT-323
BAV70W	200	共陽三陰	75		300	1	50	2.5	75	4	SOT-323
BAV99W	200	串聯壹陽	75		300	1	50	2.5	75	4	SOT-323
BAS19W	200	壹陽三陰	120	200	400	1	100	0.1	100	50	SOT-323
BAS20W	200	壹陽三陰	200	200	400	1	100	0.1	150	50	SOT-323
BAS21W	200	壹陽三陰	250	200	400	1	100	0.1	200	50	SOT-323
BAW56T	150	共陽三陽	85		75	1	50	2	75	4	SOT-523
BAW70T	150	共陽三陰	85		75	1	50	2	75	4	SOT-523
BAW99T	150	串聯壹陽	85		75	1	50	2	75	4	SOT-523

VARIABLE CAPACITANCE DIODES

變容二極管

PARAMETER 參數 TYPE 型號	V _R V	R _S Ω	I _R		C ₁		C ₂		Package
			nA	V _R V	P _F V	V _R V	P _F V	V _R V	
BBY56-02W	10	0.6	5	6	39.75	1	23.5	2	SOD-523

PARAMETER TYPE 參數 型號	V _R	R _S	I _R		C ₁		C ₂		Package
			nA	V _R	P _F	V _R	P _F	V _R	
	V	Ω		V	V	V	V	V	
BB910	6	0.8	10	6	40	0.5	15	5	SOD-323
1S2638	10	0.8	100	10	8	4			SOD-323
1SV229	15	0.4	5	15	15	2	6	10	SOD-323
KV1471	16	0.8	50	10	35.6	1	7.7	4.5	SOD-323
KV1471E	18	1	50	10	35.6	1	7.7	4.5	SOD-323
HVU202B	28	0.6	10	28	15.555	2	2.275	25	SOD-323
1SV214	30	0.55	10	28	15.2	2	2.27	25	SOD-323
BB133	30	0.9	10	30	42	0.5	2.4	28	SOD-323
HVU131	65	1	100	60	0.8	1			SOD-323

PIN DIODES

PIN二極管

PARAMETER TYPE 參數 型號	V _R	I _F	I _R		RD1		RD2		Package
			μA	V _R	Ω	@I _F	Ω	@I _F	
	V	mA		V		mA		mA	
BAP50-03	50	50	0.1	50	25	0.5	3	10	SOD-323
BAP64-03	175	100	10	175	20	0.5	0.7	100	SOD-323
BAR64-02V	150	100	10	150	9	0.5	2.5	10	SOD-523

ESD PROTECTION TUBE / TVS

ESD保護管 / TVS

PARAMETER TYPE 參數 型號	V _{RRM}	V _{BR}	I _R		C _J	V _{C@IPP}	I _{PP} TP=8/20us	Peak Pulse Current I _{PP}	Package
			μA	V _{RRM}					
	V	V		V	P _F	V	A	W	
SBLC03CI	3	4	20	3	0.8	13.9	8	250	SOD-323
SBLC05CI	5	6	5	5	0.8	18.3	8	250	SOD-323
SBLC08CI	8	8.5	2	8	0.8	18.5	8	250	SOD-323
SBLC12CI	12	13.3	1	12	0.8	28.6	6	250	SOD-323
SBLC15CI	15	16.7	1	15	0.8	31.8	5	250	SOD-323
SBLC24CI	24	26.7	1	24	0.8	56	3	250	SOD-323
GBLC03CI	3	4	5	3	0.8	7	20	350	SOD-323
GBLC05CI	5	6	1	5	0.8	9.8	18	350	SOD-323
GBLC08CI	8	8.5	1	8	0.8	13.4	18	350	SOD-323
GBLC12CI	12	13.3	1	12	0.8	19	12	350	SOD-323
GBLC15CI	15	16.7	1	15	0.8	24	10	350	SOD-323
GBLC18CI	18	20	1	18	0.8	35	7	350	SOD-323
GBLC20CI	20	22	1	20	0.8	38	7	350	SOD-323
GBLC24CI	24	26.7	1	24	0.8	43	6	350	SOD-323

TYPE 型號	PARAMETER 參數	VRRM	VBR	IR		CJ	Vc@IPP	IPP TP=8/20us	Peak Pulse		Package
				μA	VRRM				A	W	
SD03C	3.3	4	40	3.3	450	10.5	20	350	SOD-323		
SD03	3.3	4	40	3.3	450	10.5	20	350	SOD-323		
SD05C	5	6	10	5	200	18	17	350	SOD-323		
SD05	5	6	10	5	300	18	17	350	SOD-323		
SD08C	8	8.5	2	8	120	24	15	350	SOD-323		
SD12C	12	13.3	1	12	75	32	11	350	SOD-323		
SD12	12	13.3	1	12	130	32	11	350	SOD-323		
SD15C	15	16.7	1	15	68	38	10	350	SOD-323		
SD15	15	16.7	1	15	120	38	10	350	SOD-323		
SD18C	18	20	1	18	57	45	9	350	SOD-323		
SD18	18	20	1	18	100	45	9	350	SOD-323		
SD20	20	22.3	1	20	90	50	8	350	SOD-323		
SD24C	24	26.7	1	24	50	52	7	350	SOD-323		
SD24	24	26.7	1	24	80	52	7	350	SOD-323		
SD36C	36	40	1	36	35	75	5	350	SOD-323		
SD36	36	40	1	36	60	75	5	350	SOD-323		
ESD5Z2.5	2.5	4	6	2.5	145	10.9	11	120	SOD-523		
ESD5Z3.3	3.3	5	1	3.3	105	14.1	11.2	158	SOD-523		
ESD5Z5.0	5	6.2	1	5	80	18.6	9.4	174	SOD-523		
ESD5Z6.0	6	6.8	1	6	70	20.5	8.8	181	SOD-523		
ESD5Z7.0	7	7.5	1	7	65	22.7	8.8	200	SOD-523		
ESD5Z7.0C	7	7.5	0.01	7.5	65	13.5	8.8	0.2	SOD-523		
ESD9D5.0C	5	5.6	1	5	15	9.8	1	100	SOD-923		
ESD0301BL	3.3	4.2	1	3.3	0.5	21	4	84	SOD-882		
ESD0501BL	5	6	0.1	5	0.5	22	4	88	SOD-882		
ESD5V0S1BL	5	5.6	0.5	5	15	18.6	9.4	174	SOD-882		
PESD5V0S1BL	5	5.6	0.5	5	15	18.6	9.4	174	SOD-882		
ESD05D6CU	5	5.6	2	5	3	14	2	35	DFN0603		
ESD3324PL	3.3	4.2	1	3.3	0.5	10	1	56	DFN2510		
ESD0524P	5	6	1	5	0.3	15	2		DFN2510		
SM05	5	6.2	10	5	110	9.8	1	300	SOT-23		
SM712	12	13.3	1	12	45	26	17		SOT-23		
	7	7.5	20	7	45	12	17				
SM12	12	13.3	1	12	60	19	1	300	SOT-23		
NUP2105	24	26.2	0.1	24	30	44	8	350	SOT-23		
ESD0504TL	5	6	1	5	0.2	15	4	60	SOT23-6		

TVS

瞬態抑制管

TYPE 型號	PARAMETER 參數	Reverse Stand-off Voltage	Breakdown Voltage VBR@IT		Test Current IT	Maximum Reverse Leakage	Max. Clamp Voltage Vc@IPP	Peak Pulse Current IPP	Peak Pulse Power Dissipation PPPM	Package	
			VRMW	MIN							MAX
UNI	BI	V	V	V	mA	μA	V	A	W		
SMAJ5.0A	SMAJ5.0CA	5	6.4	7	10	800	9.2	43.5	400	SMA	
SMAJ6.0A	SMAJ6.0CA	6	6.67	7.37	10	800	10.3	38.8	400	SMA	
SMAJ6.5A	SMAJ6.5CA	6.5	7.22	7.98	10	500	11.2	35.7	400	SMA	

TYPE 型號		PARAMETER 參數		Reverse Stand-off Voltage	Breakdown Voltage VBR@IT		Test Current IT	Maximum Reverse Leakage	Max. Clamp Voltage Vc@IPP	Peak Pulse Current IPP	Peak Pulse Power Dissipation PPPM	Package
		VRMW	MIN		MAX							
UNI	BI	V	V	V	mA	μA	V	A	W			
SMAJ7.0A	SMAJ7.0CA	7	7.78	8.6	10	200	12	33.3	400	SMA		
SMAJ7.5A	SMAJ7.5CA	7.5	8.33	9.21	1	100	12.9	31	400	SMA		
SMAJ8.0A	SMAJ8.0CA	8	8.89	9.83	1	50	13.6	29.4	400	SMA		
SMAJ8.5A	SMAJ8.5CA	8.5	9.44	10.4	1	20	14.4	27.8	400	SMA		
SMAJ9.0A	SMAJ9.0CA	9	10	11.1	1	10	15.4	26	400	SMA		
SMAJ10A	SMAJ10CA	10	11.1	12.3	1	5	17	23.5	400	SMA		
SMAJ11A	SMAJ11CA	11	12.2	13.5	1	1	18.2	22	400	SMA		
SMAJ12A	SMAJ12CA	12	13.3	14.7	1	1	19.9	20.1	400	SMA		
SMAJ13A	SMAJ13CA	13	14.4	15.9	1	1	21.5	18.6	400	SMA		
SMAJ14A	SMAJ14CA	14	15.6	17.2	1	1	23.2	17.2	400	SMA		
SMAJ15A	SMAJ15CA	15	16.7	18.5	1	1	24.4	16.4	400	SMA		
SMAJ16A	SMAJ16CA	16	17.8	19.7	1	1	26	15.4	400	SMA		
SMAJ17A	SMAJ17CA	17	18.9	20.9	1	1	27.6	14.5	400	SMA		
SMAJ18A	SMAJ18CA	18	20	22.1	1	1	29.2	13.7	400	SMA		
SMAJ20A	SMAJ20CA	20	22.2	24.5	1	1	32.4	12.3	400	SMA		
SMAJ22A	SMAJ22CA	22	24.4	26.9	1	1	35.5	11.3	400	SMA		
SMAJ24A	SMAJ24CA	24	26.7	29.5	1	1	38.9	10.3	400	SMA		
SMAJ26A	SMAJ26CA	26	28.9	31.9	1	1	42.1	9.5	400	SMA		
SMAJ28A	SMAJ28CA	28	31.1	34.4	1	1	45.4	8.8	400	SMA		
SMAJ30A	SMAJ30CA	30	33.3	36.8	1	1	48.4	8.3	400	SMA		
SMAJ33A	SMAJ33CA	33	36.7	40.6	1	1	53.3	7.5	400	SMA		
SMAJ36A	SMAJ36CA	36	40	44.2	1	1	58.1	6.9	400	SMA		
SMAJ40A	SMAJ40CA	40	44.4	49.1	1	1	64.5	6.2	400	SMA		
SMAJ43A	SMAJ43CA	43	47.8	52.8	1	1	69.4	5.8	400	SMA		
SMAJ45A	SMAJ45CA	45	50	55.3	1	1	72.7	5.5	400	SMA		
SMAJ48A	SMAJ48CA	48	53.3	58.9	1	1	77.4	5.2	400	SMA		
SMAJ51A	SMAJ51CA	51	56.7	62.7	1	1	82.4	4.9	400	SMA		
SMAJ54A	SMAJ54CA	54	60	66.3	1	1	87.1	4.6	400	SMA		
SMAJ58A	SMAJ58CA	58	64.4	71.2	1	1	93.6	4.3	400	SMA		
SMAJ60A	SMAJ60CA	60	66.7	73.7	1	1	96.8	4.1	400	SMA		
SMAJ64A	SMAJ64CA	64	71.1	78.6	1	1	103	3.9	400	SMA		
SMAJ70A	SMAJ70CA	70	77.8	86	1	1	113	3.5	400	SMA		
SMAJ75A	SMAJ75CA	75	83.3	92.1	1	1	121	3.3	400	SMA		
SMAJ78A	SMAJ78CA	78	86.7	95.8	1	1	126	3.2	400	SMA		
SMAJ85A	SMAJ85CA	85	94.4	104	1	1	137	2.9	400	SMA		
SMAJ90A	SMAJ90CA	90	100	111	1	1	146	2.7	400	SMA		
SMAJ100A	SMAJ100CA	100	111	123	1	1	162	2.5	400	SMA		
SMAJ110A	SMAJ110CA	110	122	135	1	1	177	2.3	400	SMA		
SMAJ120A	SMAJ120CA	120	133	147	1	1	193	2.1	400	SMA		
SMAJ130A	SMAJ130CA	130	144	159	1	1	209	1.9	400	SMA		
SMAJ150A	SMAJ150CA	150	167	185	1	1	243	1.6	400	SMA		
SMAJ160A	SMAJ160CA	160	178	197	1	1	259	1.5	400	SMA		
SMAJ170A	SMAJ170CA	170	189	209	1	1	275	1.5	400	SMA		
SMAJ180A	SMAJ180CA	180	201	222	1	1	292	1.4	400	SMA		
SMAJ200A	SMAJ200CA	200	224	247	1	1	324	1.2	400	SMA		
SMAJ220A	SMAJ220CA	220	246	272	1	1	356	1.1	400	SMA		
SMAJ250A	SMAJ250CA	250	279	309	1	1	405	1	400	SMA		
SMAJ300A	SMAJ300CA	300	335	371	1	1	486	0.8	400	SMA		
SMAJ350A	SMAJ350CA	350	391	432	1	1	567	0.7	400	SMA		
SMAJ400A	SMAJ400CA	400	447	494	1	1	648	0.6	400	SMA		
SMAJ440A	SMAJ440CA	440	492	543	1	1	713	0.6	400	SMA		

TYPE 型號		PARAMETER 參數	Reverse Stand-off Voltage	Breakdown Voltage VBR@IT		Test Current IT	Maximum Reverse Leakage	Max. Clamp Voltage Vc@IPP	Peak Pulse Current IPP	Peak Pulse Power Dissipation PPPM	Package
				VRMW	MIN						
UNI	BI		V	V	V	mA	μA	V	A	W	
SMBJ5.0A	SMBJ5.0CA		5	6.4	7	10	800	9.2	65.3	600	SMB
SMBJ6.0A	SMBJ6.0CA		6	6.67	7.37	10	800	10.3	58.3	600	SMB
SMBJ6.5A	SMBJ6.5CA		6.5	7.22	7.98	10	500	11.2	53.6	600	SMB
SMBJ7.0A	SMBJ7.0CA		7	7.78	8.6	10	200	12	50	600	SMB
SMBJ7.5A	SMBJ7.5CA		7.5	8.33	9.21	1	100	12.9	46.6	600	SMB
SMBJ8.0A	SMBJ8.0CA		8	8.89	9.83	1	50	13.6	44.2	600	SMB
SMBJ8.5A	SMBJ8.5CA		8.5	9.44	10.4	1	20	14.4	41.7	600	SMB
SMBJ9.0A	SMBJ9.0CA		9	10	11.1	1	10	15.4	39	600	SMB
SMBJ10A	SMBJ10CA		10	11.1	12.3	1	5	17	35.3	600	SMB
SMBJ11A	SMBJ11CA		11	12.2	13.5	1	1	18.2	33	600	SMB
SMBJ12A	SMBJ12CA		12	13.3	14.7	1	1	19.9	30.2	600	SMB
SMBJ13A	SMBJ13CA		13	14.4	15.9	1	1	21.5	28	600	SMB
SMBJ14A	SMBJ14CA		14	15.6	17.2	1	1	23.2	25.9	600	SMB
SMBJ15A	SMBJ15CA		15	16.7	18.5	1	1	24.4	24.6	600	SMB
SMBJ16A	SMBJ16CA		16	17.8	19.7	1	1	26	23.1	600	SMB
SMBJ17A	SMBJ17CA		17	18.9	20.9	1	1	27.6	21.8	600	SMB
SMBJ18A	SMBJ18CA		18	20	22.1	1	1	29.2	20.6	600	SMB
SMBJ20A	SMBJ20CA		20	22.2	24.5	1	1	32.4	18.6	600	SMB
SMBJ22A	SMBJ22CA		22	24.4	26.9	1	1	35.5	16.9	600	SMB
SMBJ24A	SMBJ24CA		24	26.7	29.5	1	1	38.9	15.5	600	SMB
SMBJ26A	SMBJ26CA		26	28.9	31.9	1	1	42.1	14.3	600	SMB
SMBJ28A	SMBJ28CA		28	31.1	34.4	1	1	45.4	13.3	600	SMB
SMBJ30A	SMBJ30CA		30	33.3	36.8	1	1	48.4	12.4	600	SMB
SMBJ33A	SMBJ33CA		33	36.7	40.6	1	1	53.3	11.3	600	SMB
SMBJ36A	SMBJ36CA		36	40	44.2	1	1	58.1	10.4	600	SMB
SMBJ40A	SMBJ40CA		40	44.4	49.1	1	1	64.5	9.3	600	SMB
SMBJ43A	SMBJ43CA		43	47.8	52.8	1	1	69.4	8.7	600	SMB
SMBJ45A	SMBJ45CA		45	50	55.3	1	1	72.7	8.3	600	SMB
SMBJ48A	SMBJ48CA		48	53.3	58.9	1	1	77.4	7.8	600	SMB
SMBJ51A	SMBJ51CA		51	56.7	62.7	1	1	82.4	7.3	600	SMB
SMBJ54A	SMBJ54CA		54	60	66.3	1	1	87.1	6.9	600	SMB
SMBJ58A	SMBJ58CA		58	64.4	71.2	1	1	93.6	6.5	600	SMB
SMBJ60A	SMBJ60CA		60	66.7	73.7	1	1	96.8	6.2	600	SMB
SMBJ64A	SMBJ64CA		64	71.1	78.6	1	1	103	5.9	600	SMB
SMBJ70A	SMBJ70CA		70	77.8	86	1	1	113	5.3	600	SMB
SMBJ75A	SMBJ75CA		75	83.3	92.1	1	1	121	5	600	SMB
SMBJ78A	SMBJ78CA		78	86.7	95.8	1	1	126	4.8	600	SMB
SMBJ85A	SMBJ85CA		85	94.4	104	1	1	137	4.4	600	SMB
SMBJ90A	SMBJ90CA		90	100	111	1	1	146	4.1	600	SMB
SMBJ100A	SMBJ100CA		100	111	123	1	1	162	3.7	600	SMB
SMBJ110A	SMBJ110CA		110	122	135	1	1	177	3.4	600	SMB
SMBJ120A	SMBJ120CA		120	133	147	1	1	193	3.1	600	SMB
SMBJ130A	SMBJ130CA		130	144	159	1	1	209	2.9	600	SMB
SMBJ150A	SMBJ150CA		150	167	185	1	1	243	2.5	600	SMB
SMBJ160A	SMBJ160CA		160	178	197	1	1	259	2.3	600	SMB
SMBJ170A	SMBJ170CA		170	189	209	1	1	275	2.2	600	SMB
SMBJ180A	SMBJ180CA		180	201	222	1	1	292	2.1	600	SMB
SMBJ188A	SMBJ188CA		188	209	231	1	1	304	2	600	SMB
SMBJ200A	SMBJ200CA		200	224	247	1	1	324	1.9	600	SMB
SMBJ220A	SMBJ220CA		220	246	272	1	1	356	1.7	600	SMB
SMBJ250A	SMBJ250CA		250	279	309	1	1	405	1.5	600	SMB
SMBJ300A	SMBJ300CA		300	335	371	1	1	486	1.3	600	SMB
SMBJ350A	SMBJ350CA		350	391	432	1	1	567	1.1	600	SMB

TYPE 型號	PARAMETER 參數	Reverse Stand-off Voltage	Breakdown Voltage VBR@IT		Test Current IT	Maximum Reverse Leakage	Max. Clamp Voltage Vc@IPP	Peak Pulse Current IPP	Peak Pulse Power Dissipation PPPM	Package	
			VRMW	MIN							MAX
			V	V							V
UNI	BI				mA	μA	V	A	W		
SMBJ400A	SMBJ400CA	400	447	494	1	1	648	0.9	600	SMB	
SMBJ440A	SMBJ440CA	440	492	543	1	1	713	0.9	600	SMB	
P6SMB6.8A	P6SMB6.8CA	5.8	6.45	7.14	10	1000	10.5	58.1	600	SMB	
P6SMB7.5A	P6SMB7.5CA	6.4	7.13	7.88	10	500	11.3	54	600	SMB	
P6SMB8.2A	P6SMB8.2CA	7.02	7.79	8.61	10	200	12.1	50.4	600	SMB	
P6SMB9.1A	P6SMB9.1CA	7.78	8.65	9.55	1	50	13.4	45.5	600	SMB	
P6SMB10A	P6SMB10CA	8.55	9.5	10.5	1	10	14.5	42.1	600	SMB	
P6SMB11A	P6SMB11CA	9.4	10.5	11.6	1	5	15.6	39.1	600	SMB	
P6SMB12A	P6SMB12CA	10.2	11.4	12.6	1	5	16.7	36.5	600	SMB	
P6SMB13A	P6SMB13CA	11.1	12.4	13.7	1	1	18.2	33.5	600	SMB	
P6SMB15A	P6SMB15CA	12.8	14.3	15.8	1	1	21.2	28.8	600	SMB	
P6SMB16A	P6SMB16CA	13.6	15.2	16.8	1	1	22.5	27.1	600	SMB	
P6SMB18A	P6SMB18CA	15.3	17.1	18.9	1	1	25.5	24.2	600	SMB	
P6SMB20A	P6SMB20CA	17.1	19	21	1	1	27.7	22	600	SMB	
P6SMB22A	P6SMB22CA	18.8	20.9	23.1	1	1	30.6	19.9	600	SMB	
P6SMB24A	P6SMB24CA	20.5	22.8	25.2	1	1	33.2	18.4	600	SMB	
P6SMB27A	P6SMB27CA	23.1	25.7	28.4	1	1	37.5	16.3	600	SMB	
P6SMB30A	P6SMB30CA	25.6	28.5	31.5	1	1	41.4	14.7	600	SMB	
P6SMB33A	P6SMB33CA	28.2	31.4	34.7	1	1	45.7	13.3	600	SMB	
P6SMB36A	P6SMB36CA	30.8	34.2	37.8	1	1	49.9	12.2	600	SMB	
P6SMB39A	P6SMB39CA	33.3	37.1	41	1	1	53.6	11.3	600	SMB	
P6SMB43A	P6SMB43CA	36.8	40.9	45.2	1	1	59.3	10.3	600	SMB	
P6SMB47A	P6SMB47CA	40.2	44.7	49.4	1	1	64.8	9.4	600	SMB	
P6SMB51A	P6SMB51CA	43.6	48.5	53.6	1	1	70.1	8.7	600	SMB	
P6SMB56A	P6SMB56CA	47.8	53.2	58.8	1	1	77	7.9	600	SMB	
P6SMB58A	P6SMB58CA	52.78	55.1	60.9	1	1	79.8	7.7	600	SMB	
P6SMB62A	P6SMB62CA	53	58.9	65.1	1	1	85	7.2	600	SMB	
P6SMB68A	P6SMB68CA	58.1	64.6	71.4	1	1	92	6.6	600	SMB	
P6SMB75A	P6SMB75CA	64.1	71.3	78.8	1	1	103	5.9	600	SMB	
P6SMB82A	P6SMB82CA	70.1	77.9	86.1	1	1	113	5.4	600	SMB	
P6SMB91A	P6SMB91CA	77.8	86.5	95.5	1	1	125	4.9	600	SMB	
P6SMB100A	P6SMB100CA	85.5	95	105	1	1	137	4.5	600	SMB	
P6SMB110A	P6SMB110CA	94	105	116	1	1	152	4	600	SMB	
P6SMB120A	P6SMB120CA	102	114	126	1	1	165	3.7	600	SMB	
P6SMB130A	P6SMB130CA	111	124	137	1	1	179	3.4	600	SMB	
P6SMB150A	P6SMB150CA	128	143	158	1	1	207	2.9	600	SMB	
P6SMB160A	P6SMB160CA	136	152	168	1	1	219	2.8	600	SMB	
P6SMB170A	P6SMB170CA	145	162	179	1	1	234	2.6	600	SMB	
P6SMB180A	P6SMB180CA	154	171	189	1	1	246	2.5	600	SMB	
P6SMB200A	P6SMB200CA	171	190	210	1	1	274	2.2	600	SMB	
P6SMB220A	P6SMB220CA	185	209	231	1	1	328	1.9	600	SMB	
P6SMB250A	P6SMB250CA	214	237	263	1	1	344	1.8	600	SMB	
P6SMB300A	P6SMB300CA	256	285	315	1	1	414	1.5	600	SMB	
P6SMB350A	P6SMB350CA	300	332	368	1	1	482	1.3	600	SMB	
P6SMB400A	P6SMB400CA	342	380	420	1	1	548	1.1	600	SMB	
P6SMB440A	P6SMB440CA	376	418	462	1	1	602	1	600	SMB	
P6SMB480A	P6SMB480CA	408	456	504	1	1	658	0.9	600	SMB	
P6SMB510A	P6SMB510CA	434	485	535	1	1	698	0.9	600	SMB	
P6SMB530A	P6SMB530CA	451	503.5	556.5	1	1	725	0.8	600	SMB	
P6SMB540A	P6SMB540CA	460	513	567	1	1	740	0.8	600	SMB	
P6SMB550A	P6SMB550CA	468	522.5	577.5	1	1	760	0.8	600	SMB	

TYPE 型號		PARAMETER 參數	Reverse Stand-off Voltage	Breakdown Voltage V _{BR@IT}		Test Current I _T	Maximum Reverse Leakage	Max. Clamp Voltage V _{c@IPP}	Peak Pulse Current I _{PP}	Peak Pulse Power Dissipation P _{PPM}	Package
				V _{RMW}	MIN						
UNI	BI		V	V	V	mA	μA	V	A	W	
SMCJ5.0A	SMCJ5.0CA		5	6.4	7	10	800	9.2	163	1500	SMC
SMCJ6.0A	SMCJ6.0CA		6	6.67	7.37	10	800	10.3	145.7	1500	SMC
SMCJ6.5A	SMCJ6.5CA		6.5	7.22	7.98	10	500	11.2	134	1500	SMC
SMCJ7.0A	SMCJ7.0CA		7	7.78	8.6	10	200	12	125	1500	SMC
SMCJ7.5A	SMCJ7.5CA		7.5	8.33	9.21	1	100	12.9	116.3	1500	SMC
SMCJ8.0A	SMCJ8.0CA		8	8.89	9.83	1	50	13.6	110.3	1500	SMC
SMCJ8.5A	SMCJ8.5CA		8.5	9.44	10.4	1	20	14.4	104.2	1500	SMC
SMCJ9.0A	SMCJ9.0CA		9	10	11.1	1	10	15.4	97.4	1500	SMC
SMCJ10A	SMCJ10CA		10	11.1	12.3	1	5	17	88.3	1500	SMC
SMCJ11A	SMCJ11CA		11	12.2	13.5	1	1	18.2	82.5	1500	SMC
SMCJ12A	SMCJ12CA		12	13.3	14.7	1	1	19.9	75.4	1500	SMC
SMCJ13A	SMCJ13CA		13	14.4	15.9	1	1	21.5	69.8	1500	SMC
SMCJ14A	SMCJ14CA		14	15.6	17.2	1	1	23.2	64.7	1500	SMC
SMCJ15A	SMCJ15CA		15	16.7	18.5	1	1	24.4	61.5	1500	SMC
SMCJ16A	SMCJ16CA		16	17.8	19.7	1	1	26	57.7	1500	SMC
SMCJ17A	SMCJ17CA		17	18.9	20.9	1	1	27.6	54.4	1500	SMC
SMCJ18A	SMCJ18CA		18	20	22.1	1	1	29.2	51.4	1500	SMC
SMCJ20A	SMCJ20CA		20	22.2	24.5	1	1	32.4	46.3	1500	SMC
SMCJ22A	SMCJ22CA		22	24.4	26.9	1	1	35.5	42.3	1500	SMC
SMCJ24A	SMCJ24CA		24	26.7	29.5	1	1	38.9	38.6	1500	SMC
SMCJ26A	SMCJ26CA		26	28.9	31.9	1	1	42.1	35.7	1500	SMC
SMCJ28A	SMCJ28CA		28	31.1	34.4	1	1	45.4	33.1	1500	SMC
SMCJ30A	SMCJ30CA		30	33.3	36.8	1	1	48.4	31	1500	SMC
SMCJ33A	SMCJ33CA		33	36.7	40.6	1	1	53.3	28.2	1500	SMC
SMCJ36A	SMCJ36CA		36	40	44.2	1	1	58.1	25.9	1500	SMC
SMCJ40A	SMCJ40CA		40	44.4	49.1	1	1	64.5	23.3	1500	SMC
SMCJ43A	SMCJ43CA		43	47.8	52.8	1	1	69.4	21.7	1500	SMC
SMCJ45A	SMCJ45CA		45	50	55.3	1	1	72.7	20.6	1500	SMC
SMCJ48A	SMCJ48CA		48	53.3	58.9	1	1	77.4	19.4	1500	SMC
SMCJ51A	SMCJ51CA		51	56.7	62.7	1	1	82.4	18.2	1500	SMC
SMCJ54A	SMCJ54CA		54	60	66.3	1	1	87.1	17.3	1500	SMC
SMCJ58A	SMCJ58CA		58	64.4	71.2	1	1	93.6	16.1	1500	SMC
SMCJ60A	SMCJ60CA		60	66.7	73.7	1	1	96.8	15.5	1500	SMC
SMCJ64A	SMCJ64CA		64	71.1	78.6	1	1	103	14.6	1500	SMC
SMCJ70A	SMCJ70CA		70	77.8	86	1	1	113	13.3	1500	SMC
SMCJ75A	SMCJ75CA		75	83.3	92.1	1	1	121	12.4	1500	SMC
SMCJ78A	SMCJ78CA		78	86.7	95.8	1	1	126	11.9	1500	SMC
SMCJ85A	SMCJ85CA		85	94.4	104	1	1	137	11	1500	SMC
SMCJ90A	SMCJ90CA		90	100	111	1	1	146	10.3	1500	SMC
SMCJ100A	SMCJ100CA		100	111	123	1	1	162	9.3	1500	SMC
SMCJ110A	SMCJ110CA		110	122	135	1	1	177	8.5	1500	SMC
SMCJ120A	SMCJ120CA		120	133	147	1	1	193	7.8	1500	SMC
SMCJ130A	SMCJ130CA		130	144	159	1	1	209	7.2	1500	SMC
SMCJ150A	SMCJ150CA		150	167	185	1	1	243	6.2	1500	SMC
SMCJ160A	SMCJ160CA		160	178	197	1	1	259	5.8	1500	SMC
SMCJ170A	SMCJ170CA		170	189	209	1	1	275	5.5	1500	SMC
SMCJ180A	SMCJ180CA		180	201	222	1	1	292	5.1	1500	SMC
SMCJ200A	SMCJ200CA		200	224	247	1	1	324	4.6	1500	SMC
SMCJ220A	SMCJ220CA		220	246	272	1	1	356	4.2	1500	SMC
SMCJ250A	SMCJ250CA		250	279	309	1	1	405	3.7	1500	SMC
SMCJ300A	SMCJ300CA		300	335	371	1	1	486	3.1	1500	SMC
SMCJ350A	SMCJ350CA		350	391	432	1	1	567	2.6	1500	SMC
SMCJ400A	SMCJ400CA		400	447	494	1	1	648	2.3	1500	SMC
SMCJ440A	SMCJ440CA		440	492	543	1	1	713	2.1	1500	SMC

TYPE 型號		PARAMETER 參數	Reverse Stand-off Voltage	Breakdown Voltage VBR@IT		Test Current IT	Maximum Reverse Leakage	Max. Clamp Voltage Vc@IPP	Peak Pulse Current IPP	Peak Pulse Power Dissipation PPPM	Package
				V _{RMW}	MIN						
UNI	BI		V	V	V	mA	μA	V	A	W	
SMDJ5.0AG	SMDJ5.0CAG		5	6.4	7	10	800	9.2	326.1	3000	SMC
SMDJ6.0AG	SMDJ6.0CAG		6	6.67	7.37	10	800	10.3	291.3	3000	SMC
SMDJ6.5AG	SMDJ6.5CAG		6.5	7.22	7.98	10	500	11.2	267.9	3000	SMC
SMDJ7.0AG	SMDJ7.0CAG		7	7.78	8.6	10	200	12	250	3000	SMC
SMDJ7.5AG	SMDJ7.5CAG		7.5	8.33	9.21	1	100	12.9	232.6	3000	SMC
SMDJ8.0AG	SMDJ8.0CAG		8	8.89	9.83	1	50	13.6	220.6	3000	SMC
SMDJ8.5AG	SMDJ8.5CAG		8.5	9.44	10.4	1	20	14.4	208.3	3000	SMC
SMDJ9.0AG	SMDJ9.0CAG		9	10	11.1	1	10	15.4	194.8	3000	SMC
SMDJ10AG	SMDJ10CAG		10	11.1	12.3	1	5	17	176.5	3000	SMC
SMDJ11AG	SMDJ11CAG		11	12.2	13.5	1	2	18.2	164.8	3000	SMC
SMDJ12AG	SMDJ12CAG		12	13.3	14.7	1	2	19.9	150.8	3000	SMC
SMDJ13AG	SMDJ13CAG		13	14.4	15.9	1	2	21.5	139.5	3000	SMC
SMDJ14AG	SMDJ14CAG		14	15.6	17.2	1	2	23.2	129.3	3000	SMC
SMDJ15AG	SMDJ15CAG		15	16.7	18.5	1	2	24.4	123	3000	SMC
SMDJ16AG	SMDJ16CAG		16	17.8	19.7	1	2	26	115.4	3000	SMC
SMDJ17AG	SMDJ17CAG		17	18.9	20.9	1	2	27.6	108.7	3000	SMC
SMDJ18AG	SMDJ18CAG		18	20	22.1	1	2	29.2	102.7	3000	SMC
SMDJ20AG	SMDJ20CAG		20	22.2	24.5	1	2	32.4	92.6	3000	SMC
SMDJ22AG	SMDJ22CAG		22	24.4	26.9	1	2	35.5	84.5	3000	SMC
SMDJ24AG	SMDJ24CAG		24	26.7	29.5	1	2	38.9	77.1	3000	SMC
SMDJ26AG	SMDJ26CAG		26	28.9	31.9	1	2	42.1	71.3	3000	SMC
SMDJ28AG	SMDJ28CAG		28	31.1	34.4	1	2	45.4	61	3000	SMC
SMDJ30AG	SMDJ30CAG		30	33.3	36.8	1	2	48.4	62	3000	SMC
SMDJ33AG	SMDJ33CAG		33	36.7	40.6	1	2	53.3	56.3	3000	SMC
SMDJ36AG	SMDJ36CAG		36	40	44.2	1	2	58.1	51.6	3000	SMC
SMDJ40AG	SMDJ40CAG		40	44.4	49.1	1	2	64.5	46.5	3000	SMC
SMDJ43AG	SMDJ43CAG		43	47.8	52.8	1	2	69.4	43.2	3000	SMC
SMDJ45AG	SMDJ45CAG		45	50	55.3	1	2	72.7	41.3	3000	SMC
SMDJ48AG	SMDJ48CAG		48	53.3	58.9	1	2	77.4	38.8	3000	SMC
SMDJ51AG	SMDJ51CAG		51	56.7	62.7	1	2	82.4	36.4	3000	SMC
SMDJ54AG	SMDJ54CAG		54	60	66.3	1	2	87.1	34.4	3000	SMC
SMDJ58AG	SMDJ58CAG		58	64.4	71.2	1	2	93.6	32.1	3000	SMC
SMDJ60AG	SMDJ60CAG		60	66.7	73.7	1	2	96.8	31	3000	SMC
SMDJ64AG	SMDJ64CAG		64	71.1	78.6	1	2	103	29.1	3000	SMC
SMDJ70AG	SMDJ70CAG		70	77.8	86	1	2	113	26.5	3000	SMC
SMDJ75AG	SMDJ75CAG		75	83.3	92.1	1	2	121	24.8	3000	SMC
SMDJ78AG	SMDJ78CAG		78	86.7	95.8	1	2	126	23.8	3000	SMC
SMDJ85AG	SMDJ85CAG		85	94.4	104	1	2	137	21.9	3000	SMC
SMDJ90AG	SMDJ90CAG		90	100	111	1	2	146	20.5	3000	SMC
SMDJ100AG	SMDJ100CAG		100	111	123	1	2	162	18.5	3000	SMC
SMDJ110AG	SMDJ110CAG		110	122	135	1	2	177	16.9	3000	SMC
SMDJ120AG	SMDJ120CAG		120	133	147	1	2	193	15.5	3000	SMC
SMDJ130AG	SMDJ130CAG		130	144	159	1	2	209	14.4	3000	SMC
SMDJ150AG	SMDJ150CAG		150	167	185	1	2	243	12.3	3000	SMC
SMDJ160AG	SMDJ160CAG		160	178	197	1	2	259	11.6	3000	SMC
SMDJ170AG	SMDJ170CAG		170	189	209	1	2	275	10.9	3000	SMC

TYPE 型號		PARAMETER 參數	Reverse Stand-off Voltage	Breakdown Voltage VBR@IT		Test Current IT	Maximum Reverse Leakage	Max. Clamp Voltage Vc@IPP	Peak Pulse Current IPP	Peak Pulse Power Dissipation PPPM	Package
				V _{RMW}	MIN						
UNI	BI		V	V	V	mA	μA	V	A	W	
SMF5.0A			5	6.4	7	10	200	9.2	21.7	200	SOD-123FL
SMF6.0A			6	6.7	7.4	10	100	10.3	19.4	200	SOD-123FL
SMF6.5A			6.5	7.2	8	10	75	11.2	17.9	200	SOD-123FL
SMF7.0A			7	7.8	8.6	10	50	12	16.7	200	SOD-123FL
SMF7.5A			7.5	8.3	9.2	1	50	12.9	15.5	200	SOD-123FL
SMF8.0A			8	8.9	9.8	1	25	13.6	14.7	200	SOD-123FL
SMF8.5A			8.5	9.4	10.4	1	10	14.4	13.9	200	SOD-123FL
SMF9.0A			9	10	11.1	1	5	15.4	13	200	SOD-123FL
SMF10A			10	11.1	12.3	1	2.5	17	11.8	200	SOD-123FL
SMF11A			11	12.2	13.5	1	2.5	18.2	11	200	SOD-123FL
SMF12A			12	13.3	14.7	1	2.5	19.9	10.1	200	SOD-123FL
SMF13A			13	14.4	15.9	1	1	21.5	9.3	200	SOD-123FL
SMF14A			14	15.6	17.2	1	1	23.2	8.6	200	SOD-123FL
SMF15A			15	16.7	18.5	1	1	24.4	8.2	200	SOD-123FL
SMF16A			16	17.8	19.7	1	1	26	7.7	200	SOD-123FL
SMF17A			17	18.9	20.9	1	1	27.6	7.2	200	SOD-123FL
SMF18A			18	20	22.1	1	1	29.2	6.8	200	SOD-123FL
SMF20A			20	22.2	24.5	1	1	32.4	6.2	200	SOD-123FL
SMF22A			22	24.4	26.9	1	1	35.5	5.6	200	SOD-123FL
SMF24A			24	26.7	29.5	1	1	38.9	5.1	200	SOD-123FL
SMF26A			26	28.9	31.9	1	1	42.1	4.8	200	SOD-123FL
SMF28A			28	31.1	34.4	1	1	45.4	4.4	200	SOD-123FL
SMF30A			30	33.3	36.8	1	1	48.4	4.1	200	SOD-123FL
SMF33A			33	36.7	40.6	1	1	53.3	3.8	200	SOD-123FL
SMF36A			36	40	44.2	1	1	58.1	3.4	200	SOD-123FL
SMF40A			40	44.4	49.1	1	1	64.5	3.1	200	SOD-123FL
SMF43A			43	47.8	52.8	1	1	69.4	2.9	200	SOD-123FL
SMF45A			45	50	55.3	1	1	72.7	2.8	200	SOD-123FL
SMF48A			48	53.3	58.9	1	1	77.4	2.6	200	SOD-123FL
SMF51A			51	56.7	62.7	1	1	82.4	2.4	200	SOD-123FL
SMF54A			54	60	66.3	1	1	87.1	2.3	200	SOD-123FL
SMF58A			58	64.4	71.2	1	1	93.6	2.1	200	SOD-123FL
SMF60A			60	66.7	73.7	1	1	96.8	1.8	200	SOD-123FL
SMF64A			64	71.1	78.6	1	1	103	1.7	200	SOD-123FL
SMF70A			70	77.8	86	1	1	113	1.5	200	SOD-123FL
SMF75A			75	83.3	92.1	1	1	121	1.4	200	SOD-123FL
SMF78A			78	86.7	95.8	1	1	126	1.4	200	SOD-123FL
SMF85A			85	94.4	104	1	1	137	1.2	200	SOD-123FL
SMF90A			90	100	111	1	1	146	1.2	200	SOD-123FL
SMF100A			100	111	123	1	1	162	1.1	200	SOD-123FL
SMF110A			110	122	135	1	1	177	1	200	SOD-123FL
SMF120A			120	133	147	1	1	193	0.9	200	SOD-123FL
SMF130A			130	144	159	1	1	209	0.8	200	SOD-123FL
SMF150A			150	167	185	1	1	243	0.7	200	SOD-123FL
SMF160A			160	178	197	1	1	259	0.7	200	SOD-123FL
SMF170A			170	189	209	1	1	275	0.6	200	SOD-123FL
SMF175A			175	198	214	1	1	284	0.6	200	SOD-123FL

BIPOLAR TRANSISTORS

雙極型晶體管

PARAMETER 參數 TYPE 型號	POLARITY	PCM	Ic	BVcBo	BVcEO	BVeBo	HFE				VCE(SAT)			FT	Package
							MIN	MAX	@VCE	@Ic	V	@Ic	Ib		
									V	mA		mA	MHz		
2SC2714	NPN	100	20	30	15	5	100	200	5	1	0.5	10	1	550MIN	SOT-23
S9016	NPN	200	25	30	20	5	70	200	5	1	0.3	10	1	300MIN	SOT-23
S9018	NPN	200	50	30	15	5	100	200	5	1	0.5	10	1	700MIN	SOT-23
2SC2223	NPN	225	50	30	20	3	40	180	1	3	0.4	10	1	600MIN	SOT-23
2SC2757	NPN	150	50	30	15	5	105	195	5	1	0.5	10	1	600MIN	SOT-23
MMBT5087	PNP	200	-50	-50	-45	-5	150	400	-5	-1	-0.65	-100	-5	100MIN	SOT-23
BC846	NPN	200	100	80	65	6	110	800	5	2	0.5	100	-5	100MIN	SOT-23
2SA812	PNP	200	-100	-60	-50	-5	90	600	-6	-1	-0.3	-100	-10	180	SOT-23
2SC1623	NPN	200	100	60	50	5	90	600	6	1	0.3	100	10	250	SOT-23
2SC2812	NPN	200	100	60	50	5	200	400	6	1	0.3	100	10	250	SOT-23
MMBT5089	NPN	200	100	30	25	4.5	400	1200	5		0.5	10	1	50MIN	SOT-23
S9014	NPN	200	100	50	45	5	300	400	5	1	0.6	100	5	100MIN	SOT-23
S9015	PNP	200	-100	-50	-45	-5	300	400	-5	-1	-0.65	-100	-5	100MIN	SOT-23
MMBT10	NPN	300	100	30	25	3	60		10	4	0.5	4	0.4	650MIN	SOT-23
2SA1037	PNP	200	-150	-60	-50	-6	120	560	-6	-1	-0.5	-50	-5	140	SOT-23
2SA1162	PNP	150	-150	-50	-50	-5	70	400	-6	-2	-0.3	-100	-10	80MIN	SOT-23
2SC2412K	NPN	200	150	60	50	7	180	390	6	1	0.4	50	5	160	SOT-23
2SC2712	NPN	150	150	60	50	5	70	700	6	2	0.25	100	10	80MIN	SOT-23
A733	PNP	200	-150	-60	-50	-5	120	475	-6	-1	-0.3	-100	-10	50MIN	SOT-23
A1015	PNP	200	-150	-50	-50	-5	130	400	-6	-2	-0.3	-100	-10	80MIN	SOT-23
KTA1504	PNP	150	-150	-50	-50	-5	70	400	-6	-2	-0.3	-100	-10	80MIN	SOT-23
KTC3875	NPN	150	150	60	50	5	70	700	6	2	0.25	100	10	80MIN	SOT-23
KTC3875S	NPN	200	150	60	50	5	70	700	-6	2	0.25	100	10	80MIN	SOT-23
KTC4075	NPN	100	150	60	50	5	70	700	6	2	0.25	100	10	80MIN	SOT-23
C945	NPN	200	150	60	50	5	130	400	6	1	0.3	100	10	150	SOT-23
C1815	NPN	200	150	60	50	5	70	700	6	2	0.25	100	10	80MIN	SOT-23
2SB709A	PNP	200	-200	-45	-45	-7	160	460	-10	-2	-0.5	-100	-10	60MIN	SOT-23
2SC3052	NPN	150	200	50	50	6	150	800	6	1	0.3	100	10	180MIN	SOT-23
FMMT4124	NPN	330	200	30	25	5	120	360	1	2	0.3	50	-5	300MIN	SOT-23
KTC3880	NPN	200	200	30	18	4	40	200	5	1	0.5	10	1	600MIN	SOT-23
MMBT3904	NPN	225	200	60	40	6	100	300	1	10	0.3	50	5	300MIN	SOT-23
MMBT3904K	NPN	200	200	60	40	6	100	300	1	10	0.3	50	5	300MIN	SOT-23
MMBT3906	PNP	225	-200	-40	-40	-5	100	300	-1	-10	-0.4	-50	-5	250	SOT-23
MMBT3906K	PNP	200	-200	-40	-40	-5	100	300	-1	-10	-0.3	-50	-5	300MIN	SOT-23
FMMT458	NPN	500	225	400	400	5	100	300	10	50	0.5	50	6	50MIN	SOT-23
2SA1036	PNP	225	-500	-40	-40	-5	180	390	-2	-150	-0.75	-500	-50	200MIN	SOT-23
2SD1781	NPN	300	500	40	25	5	120	390	1	50	0.6	500	50	150MIN	SOT-23
2SB1198K	PNP	200	-500	-80	-80	-5	120	390	-3	-100	-0.5	-500	-50	180	SOT-23
BC817	NPN	310	500	50	45	5	100	630	1	100	0.7	500	50	100	SOT-23
KSA1182	PNP	150	-500	-35	-30	-5	70	240	-1	-100	-0.25	-100	-10	200	SOT-23
KTA1505	PNP	150	-500	-35	-30	-5	70	400	-1	-100	-0.25	-100	-10	200MIN	SOT-23
MMBTA05	NPN	225	500	60	60	4	100		1	100	0.25	100	10	100MIN	SOT-23
MMBTA06	NPN	225	500	80	80	4	100		1	100	0.25	100	10	100MIN	SOT-23
MMBTA42	NPN	225	500	300	300	6	40		10	10	0.5	20	2	50MIN	SOT-23
MMBTA43	NPN	225	500	200	200	6	40		10	10	0.5	20	2	50MIN	SOT-23
MMBTA55	PNP	225	-500	-60	-60	-4	100		-1	-10	-0.25	-100	-10	50MIN	SOT-23
MMBTA56	PNP	225	-500	-80	-80	-4	100		-1	-10	-0.25	-100	-10	50MIN	SOT-23
MMBTA92	PNP	300	-500	-300	-300	-5	40		-10	-10	-0.5	-20	-2	50MIN	SOT-23

PARAMETER 參數 TYPE 型號	POLARITY	PCM	Ic	BVcbo	BVceo	BVebo	HFE				VCE(SAT)			Ft	Package
							MIN	MAX	@VCE	@Ic	V	@Ic	Ib		
									V	mA		V	mA		
S8050	NPN	300	500	40	25	5	120	350	1	50	0.6	500	50	150MIN	SOT-23
S8550	PNP	300	-500	-40	-25	-5	120	350	-1	-50	-0.6	-500	-50	150MIN	SOT-23
S9012	PNP	300	-500	-40	-25	-5	120	350	-1	-50	-0.6	-500	-50	150MIN	SOT-23
S9013	NPN	300	500	40	25	5	120	350	1	50	0.6	500	50	150MIN	SOT-23
2SC2713-BL	NPN	300	600	180	160	6	100	300	5	10	0.2	50	5	100MIN	SOT-23
MMBT4401	NPN	225	600	60	40	6	100	300	1	150	0.4	150	15	250MIN	SOT-23
MMBT4403	PNP	225	-600	-40	-40	-5	100	300	-2	-150	-0.4	-150	-15	200MIN	SOT-23
MMBT5401	PNP	225	-600	-160	-150	-5	60	240	-5	-10	-0.5	-50	-5	100MIN	SOT-23
MMBT5550	NPN	225	600	160	140	6	60	250	5	10	0.25	50	5		SOT-23
MMBT5551	NPN	225	600	160	140	6	80	250	5	10	0.2	50	5		SOT-23
MMBT2222A	NPN	225	600	75	40	6	100	300	10	150	1	500	50	300MIN	SOT-23
MMBT2907A	PNP	225	-600	-60	-60	-5	100	600	-10	-150	-1.6	-500	-50	200MIN	SOT-23
2SB624	PNP	200	-700	-30	-25	-5	110	400	-1	-100	-0.6	-700	-70	160	SOT-23
2SD596	NPN	200	700	30	25	5	110	400	1	100	0.6	700	70	170MIN	SOT-23
2SA1362	PNP	200	-800	-15	-15	-5	120	400	-1	-100	-0.2	-400	-8	120	SOT-23
2SB1197K	PNP	200	-800	-40	-32	-5	120	390	-3	-100	-0.5	-500	-50	200MIN	SOT-23
2SC5344	NPN	200	800	35	30	5	100	320	1	100	0.5	500	50	120MIN	SOT-23
BC807	PNP	300	800	-50	-45	-5	100	630	-1	-100	-0.7	-500	-50	100	SOT-23
KTA1298	PNP	200	-800	-35	-30	-5	100	320	-1	-100	-0.4	-500	-20	120	SOT-23
KTC3265	NPN	200	800	35	30	5	100	320	1	100	0.5	500	20	120	SOT-23
SK8050	NPN	300	800	40	25	5	200	350	1	50	0.6	500	50	150MIN	SOT-23
SK8550	PNP	300	-800	-40	-25	-5	200	350	-1	-50	-0.6	-500	-50	150MIN	SOT-23
M28S	PNP	200	-1000	-40	-20	-6	300	1000	-1	-100	-0.55	-600	-20	100MIN	SOT-23
FMMT489	NPN	350	1000	40	25	6	200	400	1	100	0.5	800	80	120MIN	SOT-23
FMMT491	NPN	300	1000	80	60	5	200	350	1	100	0.5	800	80	100MIN	SOT-23
FMMT589	PNP	350	-1000	-40	-25	-6	200	400	-1	-100	-0.5	-800	-80	120MIN	SOT-23
FMMT591	PNP	500	-1000	-80	-60	-5	100	300	-5	-500	-0.6	-1000	-100	150MIN	SOT-23
FMMT618	NPN	625	1500	20	20	5	200	360	2	2000	0.2	2500	50	100MIN	SOT-23
FMMT718	PNP	625	-1500	-20	-20	-5	150	230	-2	-2000	-0.22	-1500	-50	150MIN	SOT-23
SS8050	NPN	350	1500	40	25	6	200	350	1	800	0.5	800	80	120MIN	SOT-23
SS8550	PNP	350	-1500	-40	-25	-6	200	350	-1	-800	-0.5	-800	-80	120MIN	SOT-23
FMMT617	NPN	625	2000	15	15	5	300	450	2	200	0.1	1000	10	80MIN	SOT-23
B772S	PNP	1000	3000	-40	-30	-5			-2	1000	-0.5	-2000	-200	80	SOT-23
D882S	NPN	1000	3000	40	30	5	60	400	2	1000	0.5	2000	200	90	SOT-23
S9018W	NPN	225	30	30	25	3	60	270	10	4	0.5	4	0.4	650MIN	SOT-323
2SA1611	PNP	150	-100	-60	-50	-5	90	600	-6	-1	-0.3	-100	-10	180	SOT-323
2SC4177	NPN	150	100	60	50	5	90	600	6	1	0.3	100	10	250	SOT-323
2SC4081	NPN	200	150	60	50	7	120	560	6	1	0.4	50	5	180	SOT-323
SS8050W	NPN	200	1500	40	25	6	120	400	1	100	0.5	800	80	100MIN	SOT-323
SS8550W	PNP	200	-1500	-40	-25	-6	120	400	-1	-100	-0.5	-800	-80	100MIN	SOT-323
S9014T	NPN	200	100	50	45	5	200	1000	5		0.3	100	5	150MIN	SOT-523
2SA1774R	PNP	150	-150	-60	-50	-6	120	560	-6	-1	-0.5	-50	-5	140	SOT-523
2SC4617	NPN	150	150	60	50	7	120	560	6	1	0.4	50	5	180	SOT-523
MMBT3904T	NPN	150	200	60	40	6	100	300	1	10	0.3	50	5	300MIN	SOT-523
MMBT3906T	PNP	150	-200	-40	-40	-5	100	300	-1	-10	-0.4	-50	-5	250MIN	SOT-523
MMBT3904M	NPN	100	200	60	40	6	100	300	1	10	0.3	50	5	300MIN	SOT-723
MMBT3906M	PNP	100	-200	-40	-40	-5	100	300	-1	-10	-0.3	-50	-5	300MIN	SOT-723
2SC4505	NPN	500	100	400	400	7	82	270	10	10	0.5	10	1	20	SOT-89
2SA1740	PNP	1300	-200	-400	-400	-5	60	200	-10	-50	-0.8	-50	-5	70TYP	SOT-89
2SC4548	NPN	1300	200	400	400	5	60	200	10	50	0.8	50	5	70TYP	SOT-89
2SD1005	NPN	1300	200	100	80	5	90	400	2	150	0.5	500	50	130	SOT-89
SXT5401	PNP	500	-500	-160	-150	-5	60	360	-5	-10	-0.5	-50	-5	100MIN	SOT-89
SXTA42	NPN	500	500	300	300	6	40		10	30	0.5	20	2	50MIN	SOT-89
SXTA92	PNP	500	-500	-300	-300	-5	25		-10	-30	-0.5	-20	-2	50MIN	SOT-89
SXT5551	NPN	500	600	180	160	6	80	360	5	10	0.2	50	10	100MIN	SOT-89

PARAMETER 參數 TYPE 型號	POLARITY	PCM	Ic	BV _{CBO}	BV _{CEO}	BV _{EBO}	HFE				V _{CE(SAT)}			Ft	Package
							MIN	MAX	@V _{CE}	@Ic	V	@Ic	I _B		
									V	mA		V	mA		
2SB805	PNP	2000	-700	-100	-100	-5	90	400	-1	-100	-0.6	-500	-50	75	SOT-89
2SB806	PNP	2000	-700	-120	-120	-5	90	400	-1	-100	-0.6	-500	-50	75	SOT-89
2SB1189	PNP	500	-700	-80	-80	-5	120	390	-3	-100	-0.4	-500	-50	100TYP	SOT-89
2SD1006	NPN	2000	700	100	100	5	90	400	1	100	0.6	500	50	90	SOT-89
2SA1201	PNP	500	-800	-120	-120	-5	80	240	-5	-100	-0.1	-500	-50	120TYP	SOT-89
2SC2881	NPN	500	800	120	120	5	80	240	5	100	1	500	50	120	SOT-89
2SD1000	NPN	625	800	40	25	6	120	400	1	100	0.5	800	80	100MIN	SOT-89
KTC4374	NPN	1000	800	80	80	5	100	250	2	150	0.5	500	50	130	SOT-89
PXT2222A	NPN	500	800	75	40	6	100	300	10	150	0.3	150	15	300MIN	SOT-89
2SA1013Y	PNP	500	-1000	-160	-160	-6	160	320	-5	-200	-1.5	-500	-50	15	SOT-89
2SB804	PNP	2000	-1000	-100	-80	-5	90	400	-2	-100	-0.5	-500	-50	80	SOT-89
2SB1115	PNP	2000	-1000	-60	-50	-6	135	600	-2	-100	-0.3	-1000	-50	120	SOT-89
2SB1119	PNP	500	-1000	-25	-25	-5	100	560	-2	-50	-0.7	-500	-50	180TYP	SOT-89
2SB1132	PNP	1000	-1000	-40	-32	-5	190	300	-3	-100	-0.5	-500	-50	150TYP	SOT-89
2SB1260	PNP	500	-1000	-80	-80	-5	80	390	-3	-100	-0.4	-500	-50	80	SOT-89
2SB766A	PNP	1000	-1000	-60	-50	-5	85	340	-10	-500	-0.4	-500	-50	200TYP	SOT-89
2SC2383Y	NPN	500	1000	160	160	6	160	320	5	200	1	500	50	20	SOT-89
2SD874A	NPN	500	1000	50	40	5	85	340	10	500	0.4	500	50	200	SOT-89
2SD1615	NPN	2000	1000	60	50	6	135	600	2	100	0.3	1000	50	160	SOT-89
2SD1619	PNP	500	-1000	-25	-25	-5	100	560	-2	-50	-0.7	-500	-50	180	SOT-89
2SD1664	NPN	1000	1000	40	32	6	120	390	3	100	0.5	500	50	150TYP	SOT-89
2SD1898	NPN	1000	1000	40	32	6	120	390	1	100	0.5	800	80	100	SOT-89
BC868	NPN	500	1000	32	20	5	85	375	1	500	0.5	1000	100	40MIN	SOT-89
BC869	PNP	500	-1000	-32	-20	-5	85	375	-1	-500	-0.5	-1000	-100	140	SOT-89
BCX51	PNP	1300	-1000	-45	-45	-5	63	250	-2	-150	-0.5	-500	-50	50	SOT-89
BCX52	PNP	1300	-1000	-60	-60	-5	63	250	-2	-150	-0.5	-500	-50	50	SOT-89
BCX53	PNP	1300	-1000	-100	-80	-5	63	250	-2	-150	-0.5	-500	-50	50	SOT-89
BCX54	NPN	1300	1000	45	45	5	63	250	2	150	0.5	500	50	130	SOT-89
BCX55	NPN	1300	1000	45	45	5	63	250	2	150	0.5	500	50	130	SOT-89
BCX56	NPN	1300	1000	100	80	5	63	250	2	150	0.5	500	50	130	SOT-89
BCX51-16	PNP	1300	-1000	-45	-45	-5	100	250	-2	-150	-0.5	-500	-50	50	SOT-89
BCX52-16	PNP	1300	-1000	-60	-60	-5	100	250	-2	-150	-0.5	-500	-50	50	SOT-89
BCX53-16	PNP	1300	-1000	-100	-80	-5	100	250	-2	-150	-0.5	-500	-50	50	SOT-89
BCX54-16	NPN	1300	1000	45	45	5	100	250	2	150	0.5	500	50	130	SOT-89
BCX55-16	NPN	1300	1000	45	45	5	100	250	2	150	0.5	500	50	130	SOT-89
BCX56-16	NPN	1300	1000	100	80	5	100	250	2	150	0.5	500	50	130	SOT-89
FCX491	NPN	1000	1000	80	60	5	100	300	2	150	0.5	500	50	130	SOT-89
FCX591	PNP	500	-1000	-40	-32	-5	180	390	-3	-100	-0.5	-500	-50	150MIN	SOT-89
KTC4373Y	NPN	1000	1000	100	80	5	120	240	2	150	0.5	500	50	130	SOT-89
KTD1898	NPN	500	1000	100	80	5	70	400	3	500	0.4	500	20	100	SOT-89
2SD1007	NPN	2000	1200	120	120	5	90	400	1	100	0.6	500	50	90	SOT-89
2SA1203	PNP	500	-1500	-30	-30	-5	100	320	-2	-500	-2	-1500	-30	120TYP	SOT-89
2SA1213	PNP	500	-1500	-40	-25	-5	120	240	-3	-100	-0.5	-500	-50	150TYP	SOT-89
2SA1797	PNP	500	-1500	-50	-50	-6	82	270	-2	-500	-0.35	-1000	-50	200	SOT-89
2SB798	PNP	500	-1500	-30	-25	-6	135	400	-1	-100	-0.5	-800	-80	200MIN	SOT-89
2SB799	PNP	1000	-1500	-40	-25	-6	200	300	-1	-100	-0.5	-800	-80	200MIN	SOT-89
2SB1114	PNP	1000	-1500	-40	-25	-6	135	400	-1	-100	-0.5	-800	-80	200MIN	SOT-89
2SB1123	PNP	1000	-1500	-40	-25	-6	140	400	-1	-100	-0.5	-800	-80	200MIN	SOT-89
2SB1188	PNP	1200	-1500	-40	-32	-5	190	300	-3	-100	-0.5	-500	-50	150TYP	SOT-89
2SB1424	PNP	1000	-1500	-40	-25	-6	120	390	-1	-100	-0.5	-800	-80	200MIN	SOT-89
2SC2873	NPN	1000	1500	40	25	6	70	240	1	100	0.5	800	80	100	SOT-89
2SC2883	NPN	1000	1500	40	30	6	120	320	1	100	0.5	800	80	100	SOT-89
2SC2884	NPN	1000	1500	40	25	6	200	300	1	100	0.5	800	80	100	SOT-89
2SC4672	NPN	1200	1500	40	30	6	120	270	3	100	0.5	500	50	150TYP	SOT-89
2SC5053	NPN	1000	1500	40	25	6	200	300	1	100	0.5	800	80	100TYP	SOT-89
2SD1614	NPN	1000	1500	40	25	6	135	400	1	100	0.5	800	80	100	SOT-89

PARAMETER 參數 TYPE 型號	POLARITY	PCM	Ic	BVcBO	BVcEO	BVeBO	HFE				VCE(SAT)			F _T	Package
							MIN	MAX	@VCE	@Ic	V	@Ic	I _B		
														V	
KTA1663	PNP	800	-1500	-30	-25	-6	100	320	-1	-100	-0.5	-800	-80	200MIN	SOT-89
KTC4375	NPN	500	1500	30	30	5	100	320	2	500	2	1500	30	120	SOT-89
PXT8050	NPN	625	1500	40	25	6	120	300	1	100	0.5	800	80	100MIN	SOT-89
PXT8050A	NPN	625	1500	40	25	5	250	350	1	10	0.5	800	80	100MIN	SOT-89
PXT8550	PNP	625	-1500	-40	-25	-6	120	300	-1	-100	-0.5	-800	-80	120MIN	SOT-89
PXT8550A	PNP	625	-1500	-40	-25	-5	250	350	-1	-100	-0.5	-800	-80	100MIN	SOT-89
2SA1213A	PNP	900	-2000	-50	-50	-5	70	240	-2	-500	-0.5	-1000	-50	100MIN	SOT-89
2SC2873A	NPN	500	2000	50	50	5	70	240	2	500	0.5	1000	50	120	SOT-89
2SD1766	NPN	500	2000	40	32	5	82	390	3	500	0.8	2000	200	100	SOT-89
2SB1124	PNP	500	-3000	-60	-50	-6	100	560	-2	-100	-0.7	-2000	-100	150	SOT-89
2SD1624	NPN	2500	3000	40	30	6	60	400	2	1000	0.5	2000	200	50MIN	SOT-89
2SD2150	NPN	500	3000	40	20	6	180	560	2	100	0.5	2000	100	290TYP	SOT-89
B772	PNP	-1200	-3000	-40	-32	-5	160	320	-3	-100	-0.5	-500	-50	150TYP	SOT-89
D882	NPN	1200	3000	40	30	6	60	400	2	1000	0.5	2000	200	50TYP	SOT-89
2SB1386	PNP	500	-5000	-30	-20	-6	82	390	-2	-500	-0.1	-4000	-100	120	SOT-89
2SD965	NPN	750	5000	42	22	7.5	340	1000	2	500	1	3000	100	150	SOT-89
2SD1628	NPN	500	5000	60	20	6	120	560	2	500	0.5	3000	60	120	SOT-89
2SD2098	NPN	500	5000	50	20	6	120	390	2	500	1	4000	100	150	SOT-89
PZT3904	NPN	625	200	60	40	6	100	300	1	10	0.3	50	5	300MIN	SOT-223
PZT3906	PNP	1000	-200	-40	-40	-5	100	300	-1	-10	-0.4	-50	-5	250MIN	SOT-223
PZTA42	NPN	2000	500	300	300	6	40		10	10	0.5	20	2	50TYP	SOT-223
PZTA92	PNP	2000	-500	-300	-300	-5	40		-10	-10	-0.5	-20	-2	50TYP	SOT-223
PZT2222A	NPN	1000	600	75	40	6	100	300	10	150	0.3	150	15	300	SOT-223
PZT2907A	PNP	1500	-600	-60	-60	-5	100	300	-10	-150	-0.4	-150	-15	200	SOT-223
BCP51	PNP	1300	-1000	-45	-45	-5	40	250	-2	-150	-0.5	-500	-50	115	SOT-223
BCP52	PNP	1300	-1000	-60	-60	-5	40	250	-2	-150	-0.5	-500	-50	115	SOT-223
BCP53	PNP	1300	-1000	-100	-80	-5	40	250	-2	-150	-0.5	-500	-50	115	SOT-223
BCP54	NPN	1330	1000	45	45	5	63	250	2	150	0.5	500	50	130	SOT-223
BCP55	NPN	1330	1000	60	60	5	40	250	2	150	0.5	500	50	130	SOT-223
BCP56	NPN	1330	1000	100	80	5	40	250	2	150	0.5	500	50	130	SOT-223
BCP69	PNP	625	-1000	-32	-20	-5	85	375	-1	-500	-0.5	-1000	-100	140	SOT-223
BC856	PNP	300	-100	-80	-65	-5	110	800	-5	-2	-0.2	-100	-5	100	SOT-363
BC846S	DUAL-NPN	310	100	80	65	6	110	800	5	2	0.6	100	5	100MIN	SOT-363
BC847S	DUAL-NPN	310	100	50	45	6	110	800	5	2	0.6	100	5	100MIN	SOT-363
BC848S	DUAL-NPN	310	100	30	30	5	110	800	5	2	0.6	100	5	100MIN	SOT-363
BC856S	DUAL-PNP	300	-100	-80	-65	-5	110	800	-5	-2	-0.6	-100	-5	100MIN	SOT-363
BC857S	DUAL-PNP	300	-100	-50	-45	-5	110	800	-5	-2	-0.6	-100	-5	100MIN	SOT-363
BC858S	DUAL-PNP	300	-100	-30	-30	-5	110	800	-5	-2	-0.6	-100	-5	100MIN	SOT-363
BC859S	DUAL-PNP	300	-100	-30	-30	-5	110	800	-5	-2	-0.6	-100	-5	100MIN	SOT-363
BC847BS	DUAL-NPN	200	100	50	45	5	200	450	5	2	0.4	100	5	100MIN	SOT-363
BC847PN	NPN	200	100	50	45	6	200	450	5	2	0.6	100	5	300	SOT-363
	PNP		-100	-50	-45	-5	220	475	-5	-2	-0.65	-100	-5	200	
MMDT5401	DUAL-PNP	200	-200	-160	-150	-5	60	240	-10	-5	-0.5	-50	-5	100MIN	SOT-363
MMDT5551	DUAL-NPN	200	200	180	160	6	80	250	5	10	0.2	50	5	100MIN	SOT-363
MMDT5541	PNP	225	-50	-160	-150	-5	60	240	-5	-10	-0.5	-50	-5	100MIN	SOT-363
	NPN		600	160	140	6	80	250	5	10	0.2	50	5		
MMDT4401	NPN	200	600	60	40	6	100	300	1	150	0.75	500	50	250MIN	SOT-363
MMDT4403	PNP	200	-600	-40	-40	-6	100	300	-2	-150	-0.74	-500	-50	200MIN	SOT-363

BAND-STOP TRIODES

帶阻三極管

PARAMETER TYPE 參數 型號	POLARITY	PCM	Ic	BVCBO	BVCEO	BVEBO	HFE				VCE(SAT)			FT	R1	R2	Package
							MIN	MAX	@VCE	@Ic	@Ic	Ib					
													V				
DTC144EE	NPN	150	30		50		68		5	5	0.3	10	0.5	250	47K	47K	SOT-523
DTC143EE	NPN	150	100		50									250	4.7K	10K	SOT-523
DTC114EE	NPN	150	100		50		30		5	5	0.3	10	0.5	250	10K	10K	SOT-523
DTC123JE	NPN	150	100		50		80		5	10	0.3	5	0.25	250	22K	46.2K	SOT-523
DTC143ZE	NPN	150	100		50		80		5	10	0.3	5	0.25	250	4.7K	47K	SOT-523
2SD2170	NPN	500	2000	80	80	6	1000	10000	2	1000	1.5	1000	1	80	3.5K	0.3K	SOT-89

DARLINGTON TRANSISTORS

達林頓三極管

PARAMETER TYPE 參數 型號	POLARITY	PCM	Ic	BVCBO	BVCEO	BVEBO	HFE				VCE(SAT)			FT	Package
							MIN	MAX	@VCE	@Ic	@Ic	Ib			
													V		
MMBTA13	NPN	300	300	30	30	10	5000	10000	5	100	1.5	100	0.1	125MIN	SOT-23
MMBTA14	NPN	300	300	30	30	10	10000	20000	5	100	1.5	100	0.1	125MIN	SOT-23
MMBTA63	PNP		-500	-30	-30	-10	8000		-5	-10	-1.5	-100	-0.1	125MIN	SOT-23
BCV27	NPN	200	500	40	30	10	10000		5	10	1	100	0.1	220	SOT-23
BCV47	NPN	200	500	80	60	10	4000		5	10	1	100	0.1	220	SOT-23

HIGH FREQUENCY TUBE

高頻管

PARAMETER TYPE 參數 型號	POLARITY	PCM	Ic	BVCBO	BVCEO	BVEBO	HFE				VCE(SAT)			FT	Package
							MIN	MAX	@VCE	@Ic	@Ic	Ib			
													V		
2SC3356S	NPN	200	100	20	12	2.5	90	250	10	20				7000	SOT-23
2SC4901	NPN	100	50	15	9	1.5	60	300	5	20				9000	SOT-323
2SC3356K	NPN	200	100	20	10	3	90	250	10	20				7000	SC-59
2SC4226	NPN	150	100	20	12	3	60	300	3	7				4500	SOT-323
2SC3357	NPN	1200	100	20	12	3	60	300	10	20				6500	SOT-89

MOSFETS

場效應管

PARAMETER TYPE 型號	POLARITY	Pd	Id	Vds	Vgs	DS導通	DS導通	DS導通	DS導通	Package
		W	A	V	V	@10VmΩ	@4.5VmΩ	@2.5VmΩ	@1.8VmΩ	
2SK3018	N-Channel(with ESD)	0.2	0.1	30	±20		8000	13000		SOT-23
BSN20	N-Channel		0.1	50	±20		3500@5V	1000@2.75V		SOT-23
BSS84	P-Channel(with ESD)		-0.13	-50	±20		1000@7V			SOT-23
BSS123	N-Channel	0.3	0.17	100	±20	6000	10000			SOT-23
2SK1590	N-Channel		0.2	60	±20		3500@5V	1000@2.75V		SOT-23
2SK2158	N-Channel		0.2	50	±20		3500@5V	1000@2.75V		SOT-23
BSS138	N-Channel		0.2	50	±20		3500@6V	1000@2.75V		SOT-23
BSS138T	NPN	0.25	0.22	50	±20	3500	6000			SOT-23
2N7002	N-Channel(with ESD)	0.83	0.43	60	±20	3000	4000			SOT-23
MMBF170	N-Channel(with ESD)		0.5	60	±20		3000@10V	4000@4.5V		SOT-23
2N7002K	N-Channel(with ESD)		0.5	60	±20	3800	3000			SOT-23
SK302P	P-Channel(with ESD)	0.83	-0.67	-20	±10		1200	1500		SOT-23
SK301N	N-Channel(with ESD)	0.83	0.95	25	±10		600	700		SOT-23
SK2309AA	PNP	1.2	-2	-60	±20	255	280			SOT-23
SK2371AA	PNP	1	-2	-100	±20	650	700			SOT-23
SKML2402	N-Channel		2	20	±20		52	80		SOT-23
FDV303N	N-Channel		2	20	±8		80	90		SOT-23
SK335N	N-Channel		2	20	±8		80	90		SOT-23
SK336P	P-Channel		-2	-20	±10		120	150		SOT-23
SK340P	P-Channel		-2	-20	±10		120	150		SOT-23
SKML2803	N-Channel		2	20	±10		45	59		SOT-23
NTR4502P	P-Channel		-2	-20	±10		150	180		SOT-23
SK2301AAW	PNP	0.35	-2.1	-20	±8		120	170		SOT-23
NTR5198N	N-Channel		2.2	60	±20	105	130			SOT-23
SK2308AA	N-Channel		2.3	60	±20	100	120			SOT-23
SK2301	P-Channel	0.9	-2.5	-20	±12		160	250		SOT-23
SK2302	N-Channel	0.9	2.5	20	±12		65	100		SOT-23
SK2303	P-Channel		-2.5	-20	±10		120	150		SOT-23
SK2302AA	N-Channel	1	2.9	20	±10		45	59		SOT-23
SK304P	P-Channel		-3	-16	±8		160	240		SOT-23
SK306P	P-Channel		-3	-16	±8		160	240		SOT-23
SK327N	N-Channel		3	20	±8		80	90		SOT-23
SK337N	N-Channel		3	20	±8		80	90		SOT-23
SK338P	P-Channel		-3	-20	±10		120	150		SOT-23
SK339AN	N-Channel		3	20	±8		80	90		SOT-23
SK359AN	N-Channel		3	30	±12	45	60	70		SOT-23
SKML6401	P-Channel		-3	-16	±8		110	140		SOT-23
SKML6402	P-Channel		-3	-20	±10		120	150		SOT-23
NTR2101P	P-Channel		-3	-18	±10		120	150		SOT-23
SK2301A	P-Channel		-3	-20	±12		120	150		SOT-23
SK2305	P-Channel	1.7	-3	-16	±8		160	240		SOT-23
SK2310AA	N-Channel		3	60	±20	90	110@5V			SOT-23
SK2301AA	P-Channel		-3	-16	±8		160	240		SOT-23
SK360P	P-Channel		-3.2	-30	±12	55	70	120		SOT-23
PMV37EN	N-Channel		3.2	30	±12	35	40	55		SOT-23
SK2301AAVP	P-Channel	1	-3.4	-20	±10		64	80	95	SOT-23
NTR4501N	N-Channel		3.5	18	±8		80	90		SOT-23
NTR4503N	N-Channel		3.6	30	±20	70	100			SOT-23

PARAMETER TYPE 型號	POLARITY	Pd	Id	Vds	Vgs	DS導通	DS導通	DS導通	DS導通	Package
		W	A	V	V	@10VmΩ	@4.5VmΩ	@2.5VmΩ	@1.8VmΩ	
SK2302A	N-Channel		3.6	16	±8		80	90		SOT-23
SK2304AA	N-Channel		3.6	30	±20	70	100			SOT-23
SK2306	N-Channel		3.6	30	±8		80	90		SOT-23
DMP3098L	P-Channel		-3.8	-30	±12	55	70	120		SOT-23
SKML5203	P-Channel		-4	-30	±12	65	80	120		SOT-23
SK2307A	P-Channel		-4	-16	±8		90	130		SOT-23
SK3415K	P-Channel(with ESD)		-4	-20	±10		60	70		SOT-23
SK2302AAVP	N-Channel	1	4.3	20	±10		27	37		SOT-23
SKML2502	N-Channel		4.5	30	±12	35	40	55		SOT-23
DMN3052L	N-Channel		5.2	30	±12	35	40	55		SOT-23
SK2300A	N-Channel		6	16	±12		50	55		SOT-23
SK2312AA	NPN	1.2	6.8	20	±10		13.5	17	22	SOT-23
SK3424	N-Channel		2	30	±12	35	40	55		SC-59
SK302P	P-Channel		-2.4	-20	±10		120	150		SC-59
RTR025P02	P-Channel		-2.5	-20	±10		120	150		SC-59
RTR030P02	P-Channel		-3	-20	±10		120	150		SC-59
APM2324A	N-Channel		3	20	±8		80	90		SC-59
SK3413	P-Channel		-3	-20	±10		120	150		SC-59
SK2301AVP	P-Channel	1	-3.4	-20	±10		64	80	95	SC-59
AO3415K	PNP		-4	-20	±10		60	70		SC-59
SK3407	P-Channel		-4.1	-30	±20		100			SC-59
SK3401	P-Channel		-4.2	-30	±12	50	70	120		SC-59
SK3402	N-Channel		4.2	30	±20	80	70			SC-59
SK3415	P-Channel		-4.2	-25	±12	130	150	180		SC-59
SK2331A	P-Channel	1.3	-4.3	-20	±12		45	55	75	SC-59
SK2302AVP	N-Channel	1	4.3	20	±10		27	37		SC-59
SK3414	N-Channel	1.4	4.5	30	±12	41	45	60		SC-59
SK3400	N-Channel		5.8	30	±12	35	40	55		SC-59
SK3416	N-Channel		6	16	±12		50	55		SC-59
SK3420	N-CHANNEL		6	20	±10		35	45		SC-59
2N7002KM	NPN	150	0.34	60	±20	1.3				SOT-723
2SK3019	N-Channel(with ESD)	0.2	0.1	30	±20		8000	13000		SOT-523
2N7002T	NPN	0.15	0.115	60	±20	7500	7500			SOT-523
SK2301AAT	P-Channel	0.35	-2.1	-20	±8		120	170		SOT-523
SK2302AAT	N-Channel	0.35	2.1	20	±8		60	115		SOT-523
2SK3018W	N-Channel	0.2	0.1	30	±20	8MAX@4V				SOT-323
2N7002W	N-Channel(with ESD)	0.2	0.115	60	±20	13.5MAX				SOT-323
SK2301AW	PNP	0.35	-3	-20	±8		90	110		SOT-323
SK2302AW	NPN	0.35	3	20	±8		45	30		SOT-323
2N7002DW	NPN	0.15	0.115	60	±20	1100	1200			SOT-363
SK02N100T	NPN	85	2	1000	±30	8800				TO-252
SK05P10	PNP		-5	-100	±20	170	190			TO-252
SKQ05P10AD	PNP		-5	-100	±20	170	190			TO-252
SK10N06	N-Channel		12.5	60	±20	10	13			TO-252
SK15N10	N-Channel		15.4	100	±20	100	110			TO-252
SK15P06	PNP	25	-16	-60	±20	40	53			TO-252
SK20N06A	N-Channel	34	20	60	±20	43	47			TO-252
SK40N15	NPN		25	150	±20	45				TO-252
SK30P10	PNP	120	-30	-100	±20	50	55			TO-252
NTD5802NS	N-Channel		34	40	±10	4.4	5.7			TO-252
SK50N06A	N-Channel	85	55	60	±20	17				TO-252
SK90N03	N-Channel(with ESD)		74	30	±20	4.8	9			TO-252
SK75N06	N-Channel		75	60	±20	8.5	12			TO-252
BR8205	Dual-N	1.14	6	20	±10		24	30		SOT23-6
SK8810MF	NPN	1.5	7	20	±8		16	19		SOT23-6

PARAMETER TYPE 參數 型號	POLARITY	Pd	Id	Vds	Vgs	DS導通	DS導通	DS導通	DS導通	Package
		W	A	V	V	@10VmΩ	@4.5VmΩ	@2.5VmΩ	@1.8VmΩ	
SDW3045	NPN	1.25	4.5	30	±20	35	25			DFN2X2
SDW2065	NPN		6.5	20	±12		20	26	40	DFN2X2-6L
SDI3068	PNP		-6.8	-30	±20	25	45			DFN2X2-6L
SDV3078	NPN	2.01	7.8	30	±20	15	21			DFN2X2-6L
SDI2085	PNP	3.3	-8.5	-15	±12		25	37	45	DFN2X2-6L
SKCS120N03ZB	NPN	23	34	30	±20	11	16			DFN3X3A-8L
SKQ50N03BD	NPN	30	50	30	±20	4.9	6.3			DFN3.3X3.3
SKQ55P02AD	PNP	38	-55	-20	±10		6.5	8	10.3	DFN3.3X3.3
SKG85G06A	N-Channel	105	85	60	±20	3	4.5			PDFN5060-8L
SK02N10-TP8	Dual-N	1.5	2.5	100	±20	152	158			SOP-8
SK4953	PNP	2	-4.9	-30	±20	53	80			SOP-8
SK9926	Dual-N		6	20	±12		33	50		SOP-8
SK14N10-P8	N-Channel	3.1	13.5	100	±20	8	10.5			SOP-8
SK15P03-P8	P-Channel	3.1	-15	-30	±20	12				SOP-8
i8810	Dual-N(with ESD)	1.3	6.8	20	±12		18	27		TSSOP-8
SK100N10PP	N-Channel	156	104	100	±20	10				PRPAK5X6

HIGH VOLTAGE MOSFETS

高壓場效應管

PARAMETER TYPE 參數 型號	POLARITY	Pd	Id	Vds	Vgs	DS導通	DS導通	DS導通	DS導通	Package
		W	A	V	V	@10VmΩ	@4.5VmΩ	@2.5VmΩ	@1.8VmΩ	
SK02N100T	N-Channel	85	2	1000	±30	8800				TO-252
SK04N65B	N-Channel	86	4	650	±30	2600				TO-252
SK05N65B	N-Channel	86	4.5	650	±30	2500				TO-252
SK07N65B	N-Channel	126	7	650	±30	1400				TO-252
SK08N65B	N-Channel	120	8	650	±30	1300				TO-252
SK10N65E	N-Channel	120	9	650	±30	1300				TO-252
SK08N65B-T	N-Channel	120	8	650	±30	1300				TO-220
SK10N65B-T	N-Channel	125	10	650	±30	900				TO-220
SK10N70B-T	N-Channel	218	10	700	±30	900				TO-220
SK12N65B-T	N-Channel	125	12	650	±30	750				TO-220
SK20N50A-T	N-Channel	175	20	500	±30	300				TO-220
SK04N65B-TF	N-Channel	30	4	650	±30	2500				TO-220F
SK05N65B-TF	N-Channel	30	5	650	±30	2500				TO-220F
SK07N65B-TF	N-Channel	42	7	650	±30	1400				TO-220F
SK08N65B-TF	N-Channel	42	8	650	±30	1300				TO-220F
SK10N65E-TF	N-Channel	42	9	650	±30	1300				TO-220F
SK10N65B-TF	N-Channel	45	10	650	±30	900				TO-220F
SK10N70B-TF	N-Channel	51	10	700	±30	900				TO-220F
SK12N65B-TF	N-Channel	73	12	650	±30	750				TO-220F
SK20N50A-TF	N-Channel	60	20	500	±30	300				TO-220F
SK20N50A-T7	N-Channel	275	20	500	±30	300				TO-247

LOW DROPOUT VOLTAGE REGULATOR

低壓差穩壓器

PARAMETER TYPE 型號	Power	V _{IN}	V _{OUT}	I _{OUT}	Accuracy	Quiescent Current	Package
	mW	V	V	mA	%	mA	
SK1117A Series	500	1.2~18	ADJ/1.2~12	800	2	5	SOT-89
SK1117 Series		1.5~18	ADJ/1.5~5	1000	2		SOT-223
SK6206 Series	250-500	1.2~11	1.2~5	300	2	0.002	SOT-23/SOT-89 /SOT-353

ADJUSTABLE ACCURATE REFERENCE SOURCE

電源基準IC

PARAMETER TYPE 型號	P _D	I _{KA}	V _{KA}	VREF@VKA=VREF	管腳排列 PIN ARRAY	Package
	mW	mA	V	@I _{KA} =10mA		
TL432A	350	100	18	1.2214~1.2586	RAC	SOT-89
TL431A	500	-100~+150	37	2.475~2.525	RAC	SOT-89
TL431	300	-100~+150	37	2.45~2.55	RCA	SOT-23
TL431N	350	-100~+150	37	2.487~2.513	CRA	SOT-23
TL432	370	100	15	1.233~1.247	RCA	SOT-23

THREE-TERMINAL VOLTAGE REGULATOR IC

三端穩壓IC

TYPE 型號	PARAMETER 參數	Po	Io	Vi	Vo@Tj=25°C	Iq	Package
		mW	mA	V	V	mA	
78L05S		350	100	30	4.8~5.2	6	SOT-23
78L06S		500	150	30	5.75~6.25	6	SOT-23
78L08S		500	100	30	7.7~8.3	6	SOT-23
78L09S		500	100	30	5.76~6.24	6	SOT-23
78L010S		500	100	30	9.6~10.4	6	SOT-23
78L12S		500	100	35	11.5~12.5	6.5	SOT-23
78L15S		500	100	30	14.4~15.6	6	SOT-23
79L05S		500	150	-30	-4.75~-5.25	6	SOT-23
79L06S		500	100	-30	-5.75~-6.25	6	SOT-23
79L08S		500	100	-30	-7.7~-8.3	6	SOT-23
79L09S		500	100	-30	-8.6~-9.4	6	SOT-23
79L010S		500	100	-30	8.64~9.36	6	SOT-23
79L12S		500	100	-35	-10.5~-11.5	-6.5	SOT-23
79L15S		500	150	-35	-14.4~-15.6	-6.5	SOT-23
78L33			200	30	3.168~3.432	5.5	SOT-89
78L05K		500	100	30	4.8~5.2	5.5	SOT-89
78L06K		500	100	30	5.76~6.24	5.5	SOT-89
78L08K		500	100	30	7.7~8.3	5.5	SOT-89
78L09K		500	100	35	8.64~9.36	6	SOT-89
78L10K		500	100	35	9.6~10.4	6	SOT-89
78L12K		500	100	35	11.5~12.5	6	SOT-89
78L15K		500	100	35	14.4~15.6	6.5	SOT-89
78L05		500	150	35	4.75~5.25	6	SOT-89
78L06		500	150	35	5.7~6.3	6	SOT-89
78L08		500	150	35	7.6~8.4	6.5	SOT-89
78L09		500	150	35	8.55~9.45	6.5	SOT-89
78L10		500	150	35	9.5~10.5	6.5	SOT-89
78L12		500	150	35	11.4~12.6	6.5	SOT-89
78L15		500	150	35	14.25~15.75	6.5	SOT-89
78L18		500	150	40	17.1~18.9	6.5	SOT-89
78L24		500	150	40	22.8~25.2	6.5	SOT-89
79L05		500	-150	-35	-4.8~-5.2	6	SOT-89
79L06		500	-150	-35	-5.76~-6.24	6	SOT-89
79L08		500	-150	-35	-7.7~-8.3	6.5	SOT-89
79L09		500	-150	-35	-8.64~-9.36	6.5	SOT-89
79L10		500	-150	-35	-9.6~-10.4	6.5	SOT-89
79L12		500	-150	-35	-11.5~-12.5	6.5	SOT-89
79L15		500	-150	-35	-14.4~-15.6	6.5	SOT-89
79L18		500	-150	-40	-17.3~-18.7	6.5	SOT-89
79L24		500	-150	-40	-23~-25	6.5	SOT-89
78M05		1300	500	35	4.8~5.2	6	TO-252
78M06		1300	500	35	5.75~6.25	6	TO-252
78M08		1300	500	35	7.8~8.3	6	TO-252
78M09		1300	500	35	8.6~9.4	6	TO-252
78M10		1300	500	35	9.6~10.4	6	TO-252
78M12		1300	500	35	11.5~12.5	6	TO-252
78M15		1300	500	35	14.4~15.6	6	TO-252

PARAMETER TYPE 型號	Po mW	Io mA	Vi V	Vo@Tj=25°C		Iq mA	Package
				V	V		
78M18	1300	500	40	17.3~18.7		6	TO-252
78M20	1300	500	40	19.2~20.8		6	TO-252
78M24	1300	500	40	23~25		6	TO-252
SK7805	1250	1000	35	4.8~5.2		6	TO-252
SK7905U		1500	35	4.75~5.25		6	TO-252
SK7912U		1500	35	11.5~12.5		6	TO-252
SK7915U		1500	35	4.8~5.2		6	TO-252
SK7905AU		1500	35	4.75~5.25		6	TO-220
SK1912AU		1500	35	11.5~12.5		6	TO-220
SK7805A		1200	35	4.8~5.2		6	TO-220
SK7806A		1200	35	5.75~6.25		6	TO-220
SK7808A		1200	35	7.7~8.3		6	TO-220
SK7809A		1200	35	8.64~9.36		6	TO-220
SK7812A		1200	35	11.5~12.5			TO-220

SISONIC

矽麥

PARAMETER TYPE 型號	VDD	IDD	SNR	Sensitivity	Package
	V	μA	dB	dBV	
SKM38A3729B-C	1.5~3.6	80~180	62	-38	MEMS
SKM42A3722T	1.5~3.6	80~180	58	-42	MEMS
SKM42A3729T-C	1.5~3.6	80~180	58	-42	MEMS

LI-ION BATTERY PROTECTION

鋰電池保護IC

Device	Vin	Series Cells	Charger Type	Output Accu.	Package
DW01B	-0.3~12V	1	Linear	4.3V±50mV	SOT23-6
BRCL3130ME	-0.3~6V	1	Linear	4.3V±50mV	SOT23-5

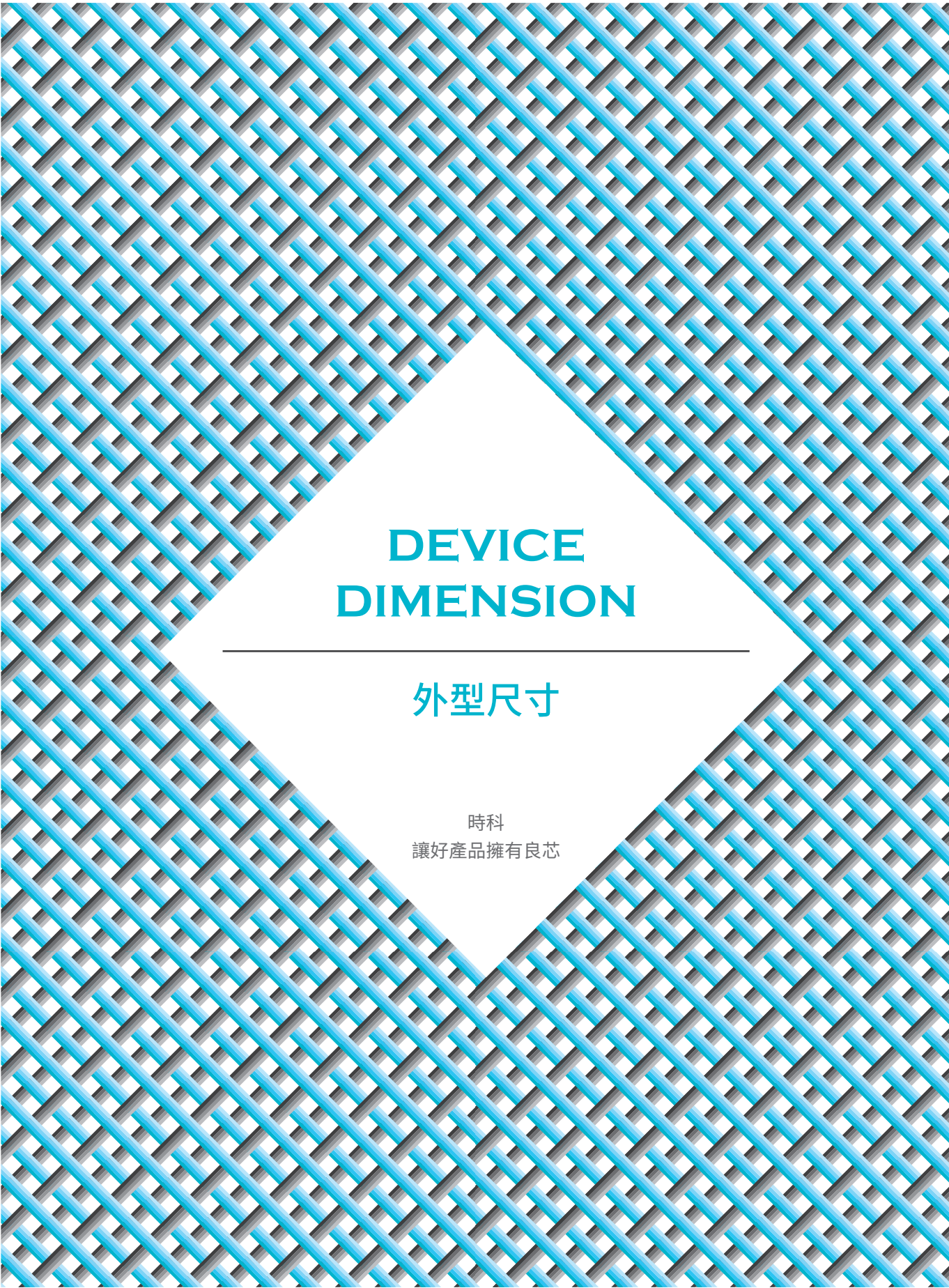

DEVICE DIMENSION

外型尺寸

時科
讓好產品擁有良芯

DFN0603

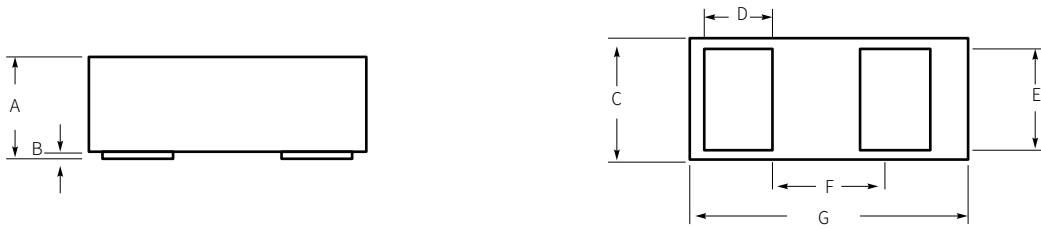

Symbol		A	B	C	D	E	F	G
mm	Max	0.33	0.025	0.35	0.22	0.29	0.355	0.65
	Min	0.27	0	0.28	0.14	0.21		0.57

SOD-882

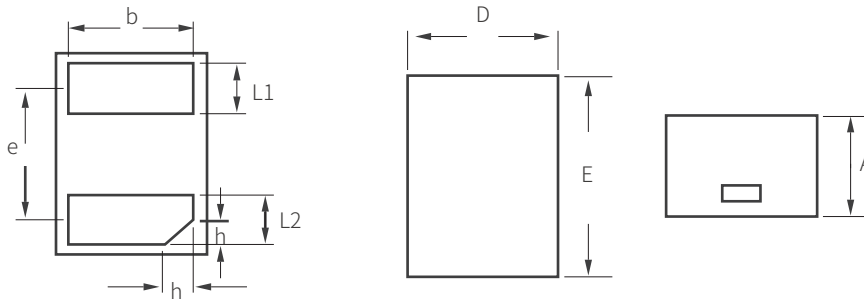

Symbol		D	E	L1	L2	b	h	A	e
mm	Min	0.55	0.95	0.2	0.2	0.45	0.07	0.45	0.65 (BSC)
	Nom	0.6	1	0.25	0.25	0.5	0.12	0.5	
	Max	0.65	1.05	0.3	0.3	0.55	0.17	0.55	

SOD-923



Symbol		A	B	C	D	E	F	G
mm	Max	0.43	0.17	0.65	0.25	0.85	1.05	0.15
	Min	0.36	0.07	0.55	0.15	0.75	0.95	0.05
Inches	Max	0.017	0.007	0.026	0.01	0.033	0.041	0.006
	Min	0.014	0.003	0.022	0.006	0.03	0.037	0.002

SOD-723

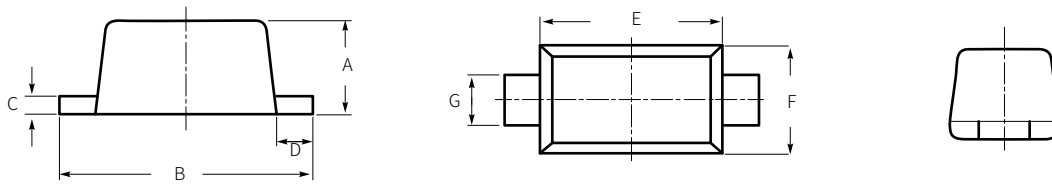

Symbol		A	B	C	D	E	F	G
mm	Max	0.57	1.5	0.15	0.25	1.1	0.7	0.33
	Min	0.47	1.3	0.05	0.15	0.9	0.5	0.23

SOD-523

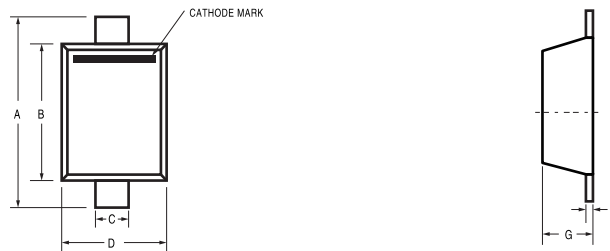

Symbol		A	B	C	D	E	G
mm	Max	1.7	1.3	0.4	0.9	0.2	0.65
	Min	1.5	1.1	0.3	0.7	0.1	0.55

SOD-323

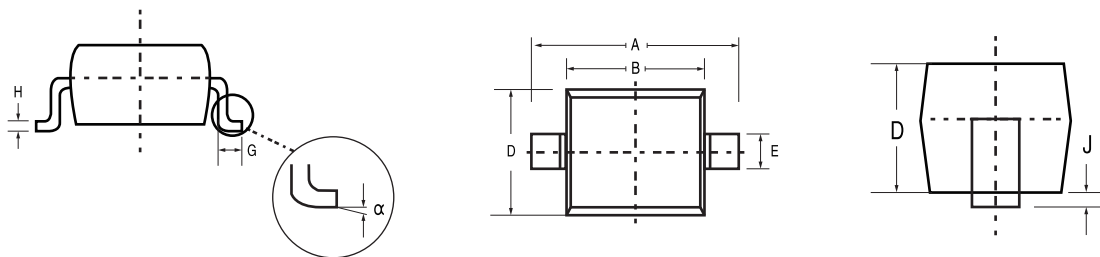

Symbol		A	B	C	D	E	G	H	J	α
mm	Max	2.7	1.8	1.4	1.05 (TYP)	0.35	0.4	0.15	0.05 (TYP)	8°
	Min	2.3	1.6	1.2		0.25	0.2	0.1		0°

SOD-123

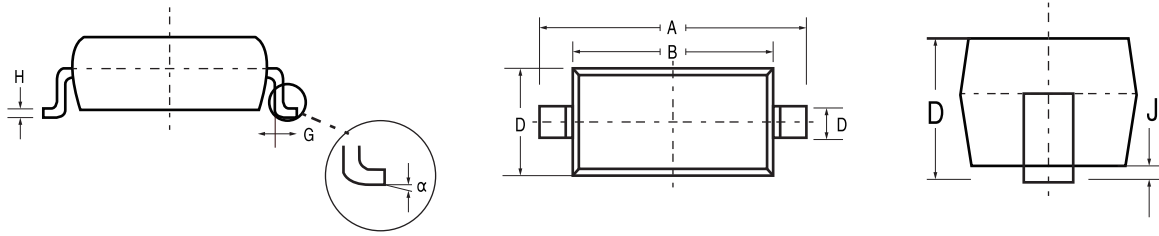

Symbol		A	B	C	D	E	G	H	J	α
mm	Max	3.85	2.85	1.7	1.35	0.55 (TYP)	0.25	0.11 (TYP)	0.1	8°
	Min	3.55	2.55	1.4						0°

SOD-123FL

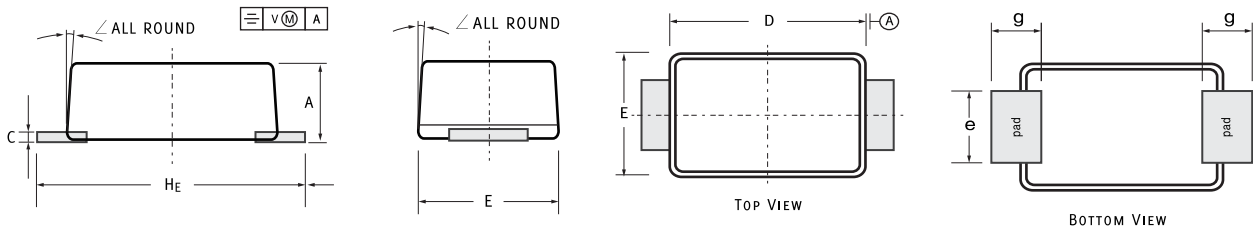

Symbol		A	C	D	E	e	g	He	∠
mm	Max	1.1	0.2	2.9	1.9	1.1	0.9	3.8	7°
	Min	0.9	0.12	2.6	1.7	0.8	0.7	3.5	
Inches	Max	0.043	0.0079	0.114	0.075	0.043	0.035	0.15	
	Min	0.035	0.0047	0.102	0.067	0.031	0.028	0.138	

SOD-123ST

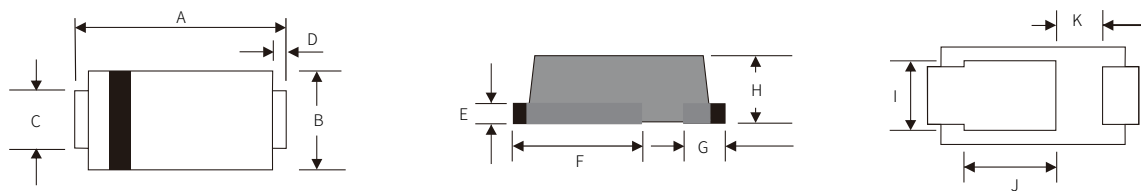

Symbol		A	B	C	D	E	F	G	H	I	J	K
mm	Max	3.9	2	1.1	0.3	0.2	2.3	1	3.8	1.3	1.5	1
	Min	3.5	1.6	0.7	0.3	0.2	1.9	0.6	3.5	0.9	1.1	0.6
Inches	Max	0.156	0.08	0.044	0.012	0.008	0.092	0.04	0.04	0.052	0.06	0.04
	Min	0.14	0.064	0.028	0.012	0.008	0.076	0.024	0.036	0.036	0.044	0.024

SOD-80

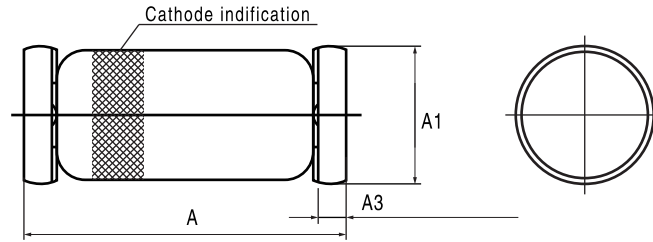

Symbol	mm			mm		
	Max	Nom	Min	Max	Nom	Min
A	3.7		3.3	0.147		0.13
A1	1.8		1.4	0.071		0.055
A3	0.47(Max)			0.019(Max)		

DO-213AA

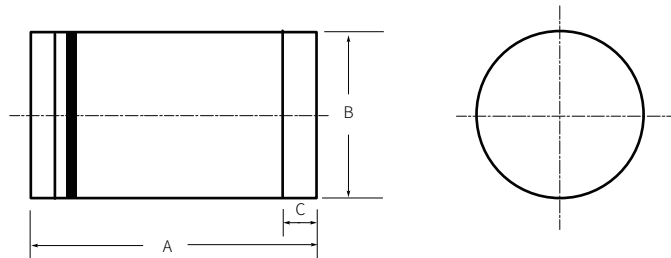

Symbol		A	B	C
mm	Max	3.65	1.7	0.6
	Min	3.45	1.5	0.4

SMA

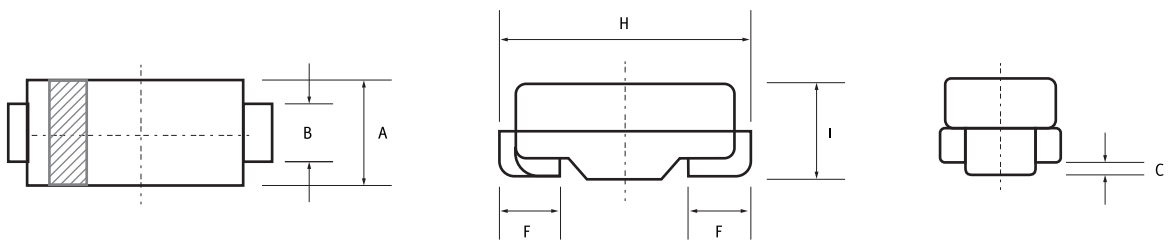

Symbol		A	B	C	D	F	H
mm	Max	2.8	1.7	0.203	2.42	1.52	5.66
	Min	2.54	1.3		1.98	0.76	4.93
Inches	Max	0.11	0.067	0.008	0.096	0.06	0.222
	Min	0.1	0.051		0.078	0.03	0.194

SMAF

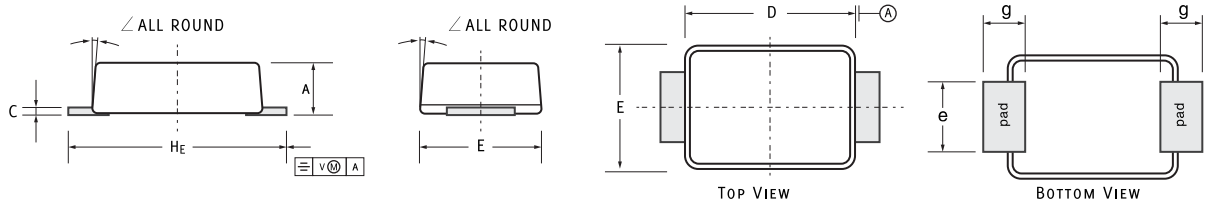

Symbol		A	C	D	E	e	g	He	∠
mm	Max	1.1	0.2	3.7	2.7	1.6	1.2	4.9	7°
	Min	0.9	0.12	3.3	2.4	1.3	0.8	4.4	
Inches	Max	0.043	0.0079	0.146	0.106	0.063	0.047	0.193	
	Min	0.035	0.0047	0.13	0.094	0.051	0.031	0.173	

SMA-HST

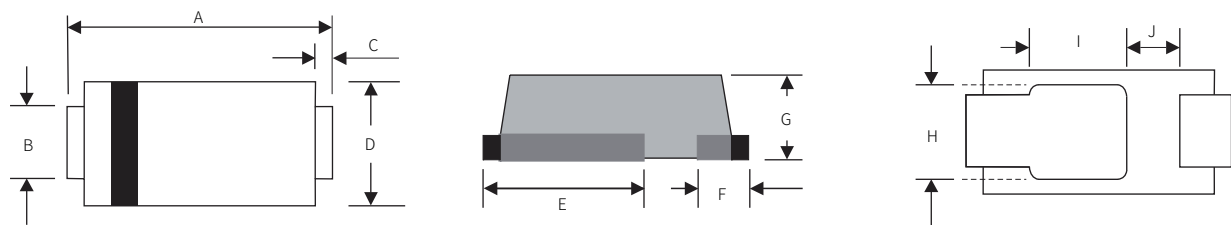

Symbol		A	B	C	D	E	F	G	H	I	J
mm	Max	5.4	1.75	0.45	2.8	3.55	1	1.05	2	2.3	0.75
	Min	5	1.15	0.45	2.4	3.55	1	0.95	1.6	1.9	0.55
Inches	Max	0.213	0.069	0.018	0.111	0.14	0.04	0.041	0.079	0.091	0.03
	Min	0.197	0.045	0.018	0.095	0.14	0.04	0.037	0.063	0.075	0.022

SMB

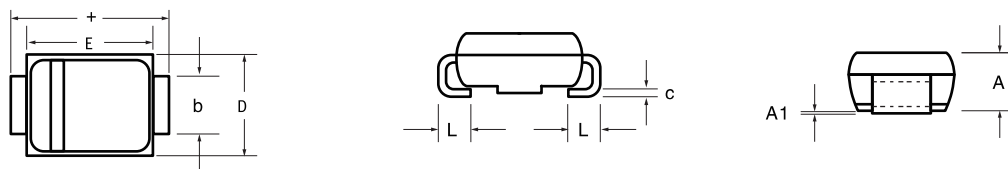

Symbol		A	A1	b	c	D	E	+	L
mm	Max	3.12	0.203	2	0.305	3.94	4.6	5.5	1.6
	Nom					3.56	4.32		1.02
	Min	2.62		1.4	0.152	3.3	4.06	5.08	0.76
Inches	Max	0.122	0.008	0.079	0.012	0.155	0.181	0.22	0.063
	Nom					0.14	0.17		0.04
	Min	0.11		0.055	0.005	0.13	0.16	0.2	0.03

SMBF

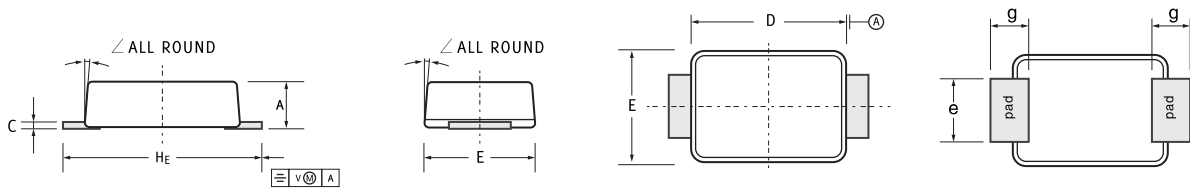

Symbol		A	C	D	E	He	e	g	∠
mm	Max	1.3	0.26	4.4	3.7	5.5	2.2	1.2	9°
	Min	1.1	0.18	4.2	3.5	5.1	1.9	0.8	
Inches	Max	0.051	0.01	0.173	0.146	0.216	0.086	0.047	
	Min	0.043	0.007	0.165	0.138	0.2	0.075	0.031	

SMC

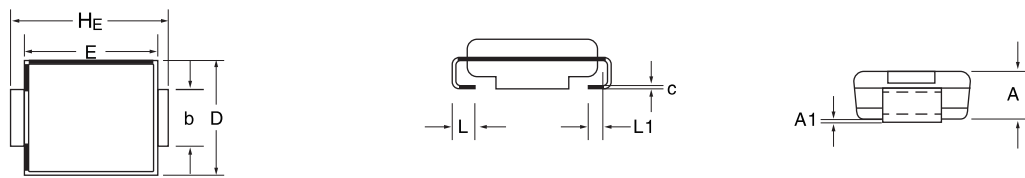

Symbol		A	A1	b	c	D	E	He	L
mm	Max	2.62	0.203	3.2	0.305	6.22	7.11	8.13	1.52
	Nom			3		5.84	6.86	7.94	1.02
	Min	2.06		2.9	0.152	5.59	6.6	7.75	0.76
Inches	Max	0.103	0.008	0.126	0.012	0.245	0.28	0.32	0.06
	Nom			0.118		0.23	0.27	0.313	0.04
	Min	0.079		0.114	0.006	0.22	0.26	0.305	0.03

SOT-723

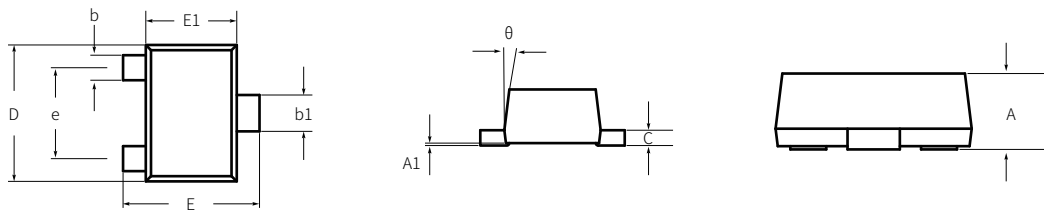

Symbol		A	A1	b	b1	c	D	E	E1	e	θ
mm	Max	0.5	0.05	0.27	0.37	0.15	1.25	1.25	0.85	0.8	7°
	Min	0.43	0	0.17	0.27	0.08	1.15	1.15	0.75		0°

SOT-523

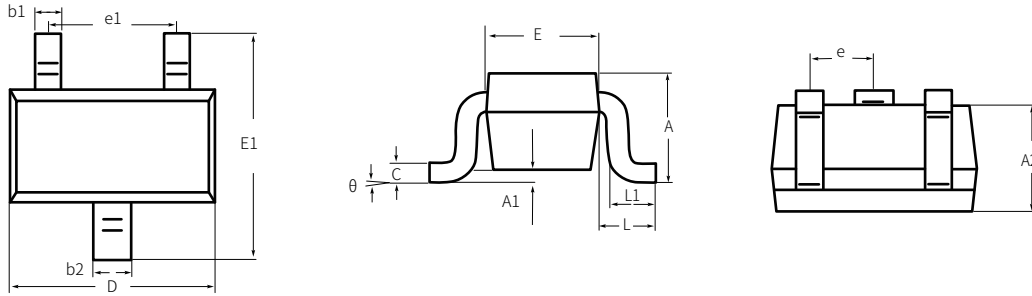

Symbol		A	A1	A2	b1	b2	c	D	E	E1	e	e1	L	L1	θ
mm	Max	0.9	0.1	0.8	0.25	0.35	0.2	1.7	0.9	1.75	0.5 (TYP)	1.1	0.4 (REF)	0.46	8°
	Min	0.7	0	0.7	0.15	0.25	0.1	1.5	0.7	1.45		0.9		0.26	0°
Inches	Max	0.035	0.004	0.031	0.01	0.014	0.008	0.067	0.035	0.069	0.02 (TYP)	0.043	0.016 (REF)	0.018	8°
	Min	0.028	0	0.028	0.006	0.01	0.004	0.059	0.028	0.057		0.035		0.01	0°

SOT-323

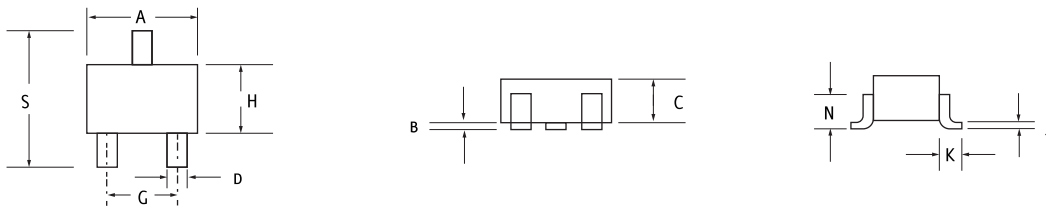

Symbol		A	B	C	D	G	H	J	K	N	S
mm	Max	2.2	1.35	1	0.4	1.4	0.1	0.25	0.425 (REF)	0.7 (REF)	2.2
	Min	1.8	1.15	0.8	0.3	1.2		0.1			2
Inches	Max	0.087	0.053	0.04	0.016	0.055	0.004	0.01	0.017 (REF)	0.028 (REF)	0.09
	Min	0.071	0.045	0.032	0.012	0.047		0.004			0.079

SOT-23

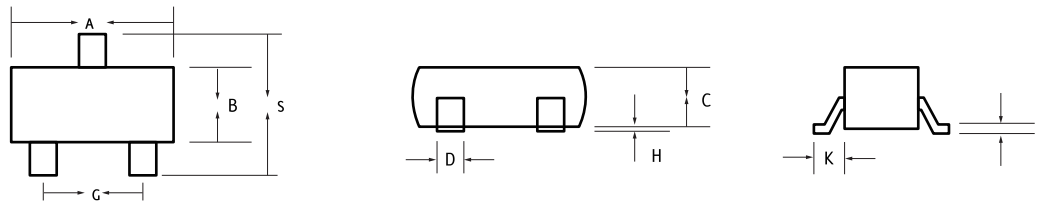

Symbol		A	B	C	D	G	H	J	K	S
mm	Max	3	1.4	1.11	0.5	2.04	0.1	0.177	0.69	2.64
	Min	2.8	1.2	0.89	0.3	1.78	0.013	0.085	0.35	2.1
Inches	Max	0.119	0.0551	0.044	0.02	0.0807	0.004	0.007	0.0285	0.1039
	Min	0.1102	0.0472	0.035	0.015	0.0701	0.0005	0.0034	0.014	0.083

SC-59

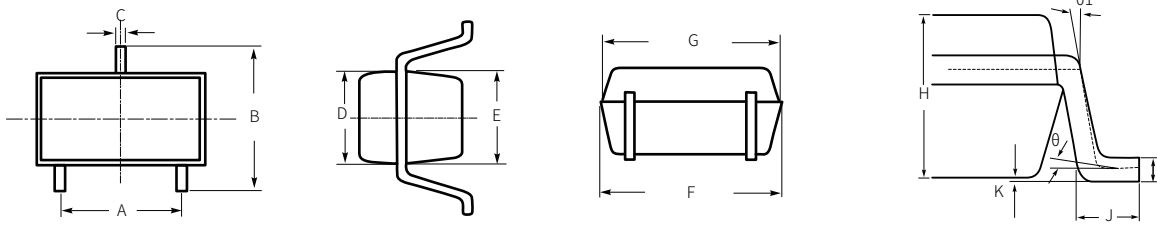

Symbol		A	B	C	D	E	F	G	H	I	J	K	θ	θ_1
mm	Max	2	3	0.5	1.57	1.6	2.95	2.92	1.5	0.22	0.55	0.1	8°	9°
	Min	1.8	2.8	0.3	1.47	1.5	2.85	2.82		0.12	0.35	0.02	0°	

SOT-89

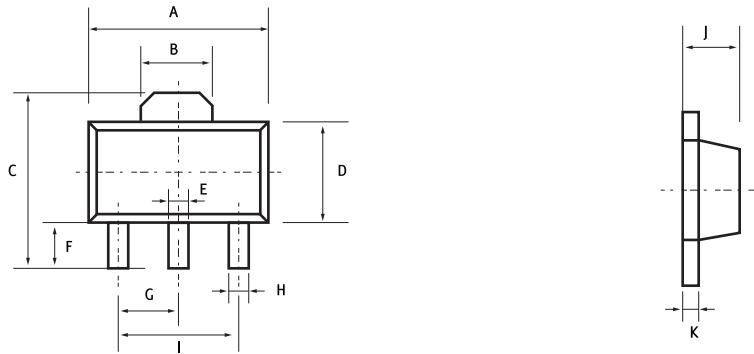

Symbol	mm		Inches	
	Max	Min	Max	Min
A	4.6	4.4	0.101	0.173
B	1.7	1.5	0.067	0.059
C	4.2	3.8	0.165	0.15
D	2.6	2.3	0.102	0.091
E	0.58	0.4	0.023	0.016
F	1.2	0.9	0.047	0.035
G	1.5(TYP)		0.06(TYP)	
H	0.52	0.32	0.02	0.013
I	3(TYP)		0.118(TYP)	
J	1.6	1.4	0.063	0.055
K	0.5	0.3	0.02	0.012

SOT-223

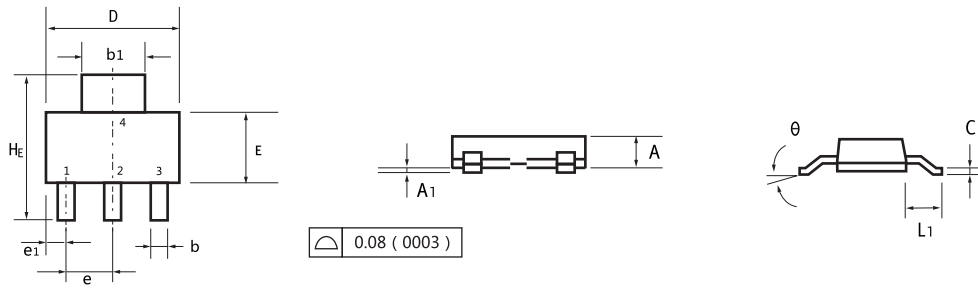

Symbol		A	A1	b	b1	c	D	E	e	e1	L1	H _E	θ
mm	Max	1.75	0.1	0.89	3.2	0.35	6.7	3.7	2.4	1.05	2	7.3	10°
	Nom	1.63	0.06	0.75	3.06	0.29	6.5	3.5	2.3	0.04	1.75	7	
	Min	1.5	0.02	0.6	2.9	0.24	6.3	3.3	2.2	0.85	1.5	6.7	0°
Inches	Max	0.068	0.004	0.035	0.126	0.014	0.263	0.145	0.094	0.041	0.078	0.287	10°
	Nom	0.064	0.002	0.03	0.121	0.012	0.256	0.138	0.091	0.037	0.069	0.276	
	Min	0.06	0.001	0.024	0.115	0.009	0.249	0.13	0.087	0.033	0.06	0.264	0°

To-277

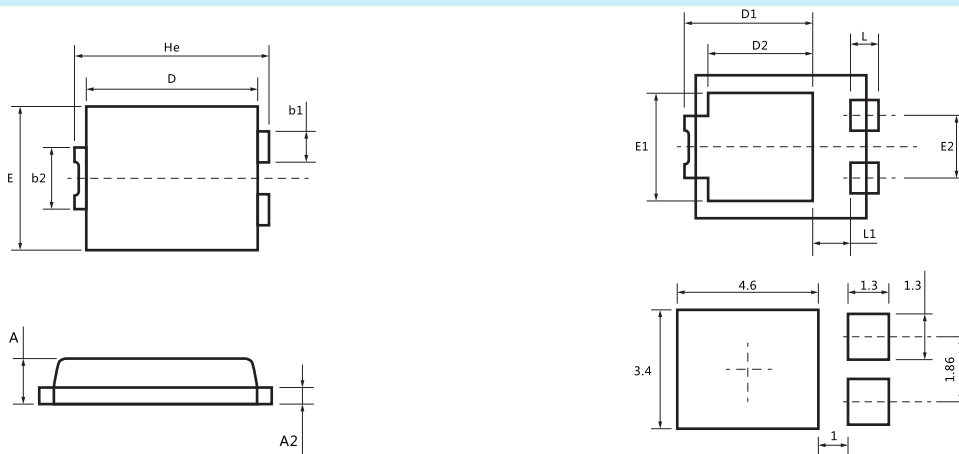

Symbol		H _e	D	E	b1	b2	A	A2	E1	E2	D1	D2	L	L1
mm	Max	6.7	5.9	4.35	1.05	1.9	1.2	0.3	3.3	1.86	4.4	3.52	1.1	1.4
	Min	6.3	5.5	4.05	0.85	1.7	1		3		4.2		0.8	1.1

TO-252

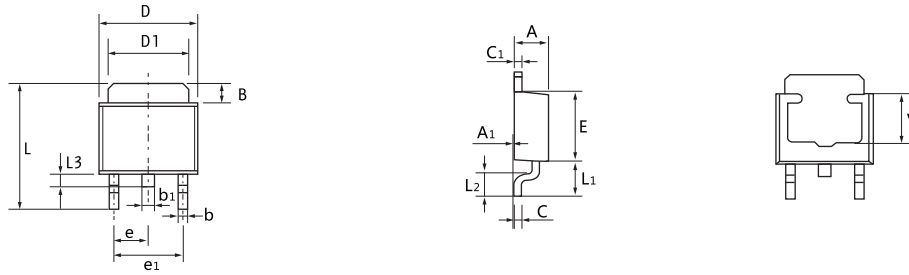

Symbol	mm		Inches	
	Max	Min	Max	Min
A	2.4	2.2	0.094	0.087
A1	0.127		0.005	
B	1.65	1.35	0.065	0.053
b	0.7	0.5	0.028	0.02
b1	0.9	0.7	0.035	0.028
c	0.58	0.43	0.023	0.017
c1	0.58	0.43	0.023	0.017
D	6.65	6.35	0.262	0.25
D1	5.4	5.2	0.213	0.205
E	5.7	5.4	0.224	0.213
e	2.3(TYP)		0.091(TYP)	
e1	4.7	4.5	0.185	0.177
L	9.9	9.5	0.39	0.374
L1	2.9	2.55	0.114	0.1
L2	1.78	1.4	0.07	0.055
L3	0.9	0.6	0.035	0.024
V	3.8(REF)		0.15(REF)	

UMSB

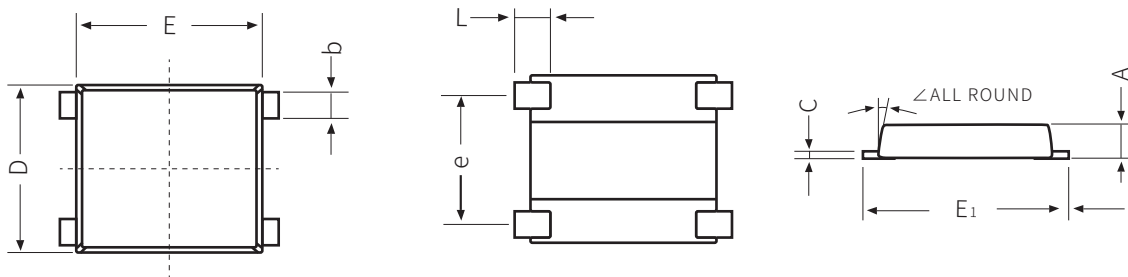

Symbol		A	C	D	E	E1	L	e	b	∠
mm	Max	1.5	0.29	7.0	7.6	8.9	1.6	5.3	1.15	10°
	Min	1.3	0.17	6.2	7.1	8.4	1.0	4.9	0.95	
Inches	Max	0.059	0.012	0.276	0.299	0.35	0.055	0.209	0.045	
	Min	0.051	0.007	0.244	0.280	0.331	0.0315	0.193	0.037	

UMB

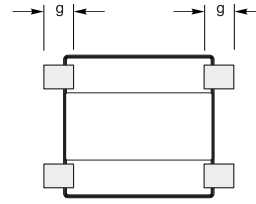
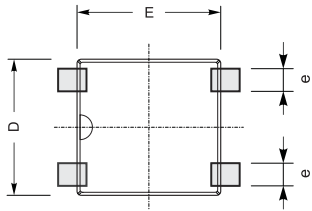
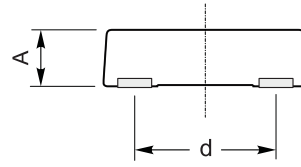
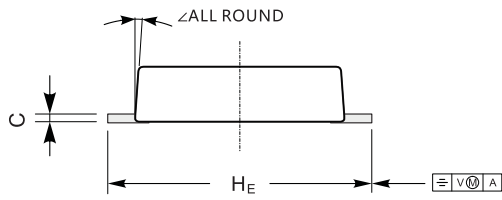

Symbol		A	C	D	E	H _E	g	d	e	∠
mm	Max	1.2	0.2	3.8	4	5.1	0.82	2.7	0.7	7°
	Min	1	0.12	3.4	3.6	4.6	0.51	2.3	0.51	
Inches	Max	0.047	0.0079	0.15	0.157	0.201	0.032	0.106	0.028	
	Min	0.039	0.0047	0.134	0.142	0.181	0.02	0.091	0.002	

ULBF

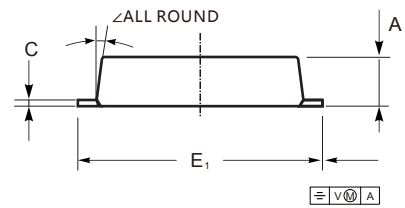
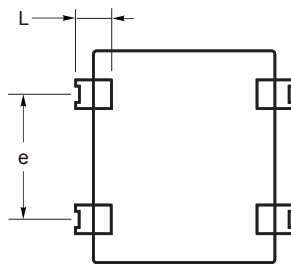
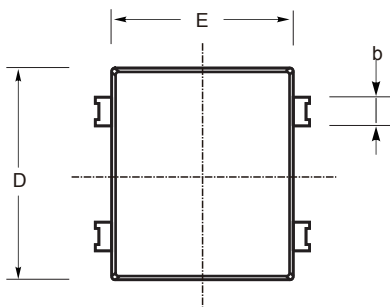

Symbol		A	C	D	E	E ₁	L	e	b	∠
mm	Max	1.75	0.55	9.8	8.8	10.2	1.25	5.3	1.55	10°
	Min	1.35	0.25	9.4	8.4	9.8	0.85	4.9	1.25	
Inches	Max	0.068	0.0216	0.385	0.346	0.401	0.049	0.209	0.061	
	Min	0.053	0.0098	0.37	0.33	0.385	0.033	0.193	0.049	

DBF

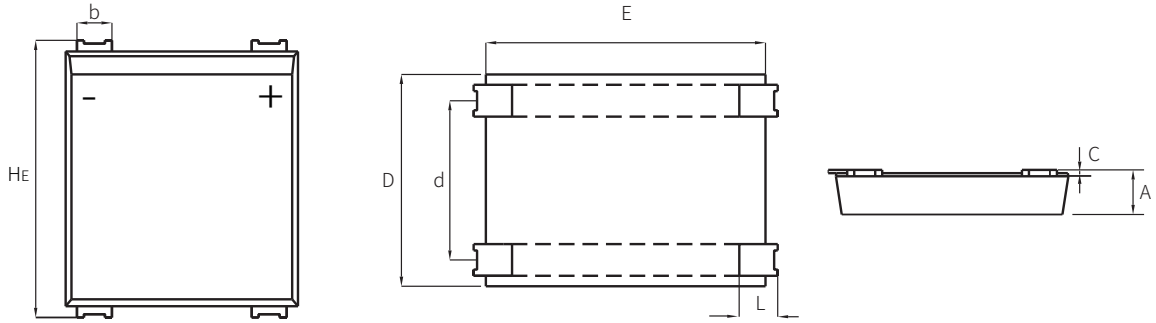

Symbol		A	b	C	D	d	E	He	L
mm	Min	1.3	0.8	0.15	6.45	4.8	7.5	8.5	0.5
	Max	1.5	1.2	0.35	6.85	5.2	8.2	8.9	1.5

ABS

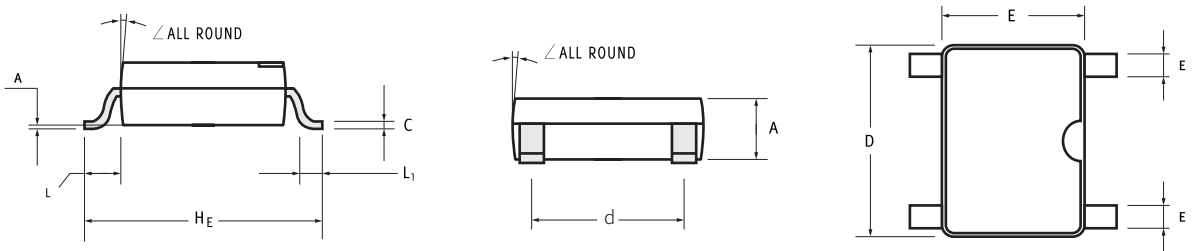

Symbol		A	C	D	E	He	d	e	L	L1	a	∠
mm	Max	1.5	0.22	5.2	4.5	6.4	4.2	0.7	0.95	0.6	0.2	7°
	Min	1.3	0.15	4.9	4.2	6	3.8	0.5				
Inches	Max	0.059	0.0087	0.205	0.177	0.252	0.165	0.028	0.037	0.024	0.004	
	Min	0.051	0.0059	0.193	0.166	0.236	0.150	0.020				

ABF

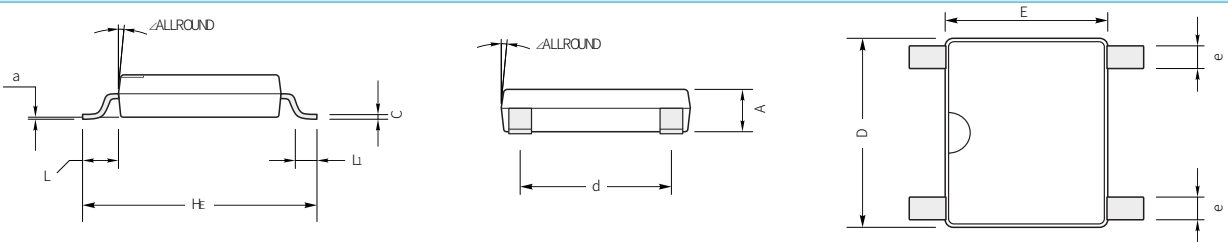

Symbol		A	C	D	E	He	d	e	L	L1	a	∠
mm	Max	1.2	0.22	5.2	4.5	6.4	4.2	0.7	0.95	0.6	0.2	7°
	Min	1	0.15	4.9	4.2	6	3.8	0.5				
Inches	Max	0.047	0.0087	0.205	0.177	0.252	0.165	0.028	0.037	0.024	0.008	
	Min	0.039	0.0059	0.193	0.166	0.236	0.15	0.02				

MBS

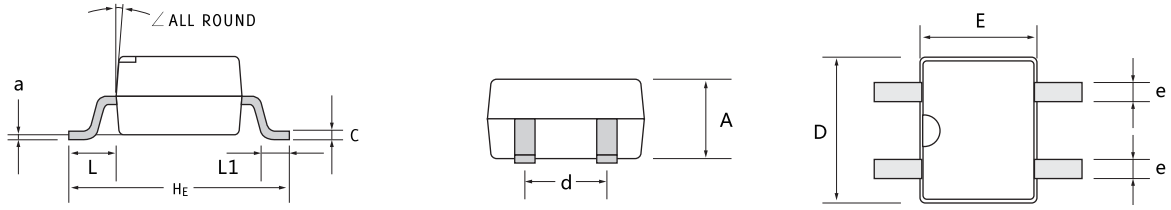

Symbol		A	C	D	E	H _E	d	e	L	L ₁	a	∠
mm	Max	2.6	0.22	5	4.1	7	2.7	0.7	1.7	1.1	0.2	7°
	Min	2.2	0.15	4.5	3.6	6.4	2.3	0.5	1.3	0.5		
Inches	Max	0.102	0.0087	0.197	0.161	0.276	0.106	0.028	0.067	0.043	0.008	
	Min	0.094	0.0059	0.177	0.142	0.252	0.091	0.02	0.051	0.02		

MBF

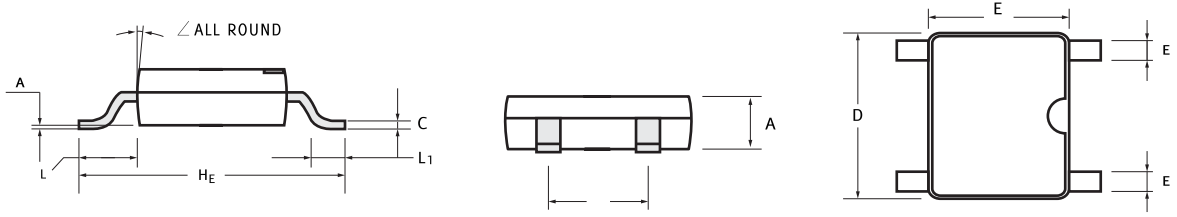

Symbol		A	C	D	E	H _E	d	e	L	L ₁	a	∠
mm	Max	1.6	0.22	5	4.1	7	2.7	0.7	1.7	1.1	0.2	7°
	Min	1.2	0.15	4.5	3.6	6.4	2.3	0.5	1.3	0.5		
Inches	Max	0.063	0.0087	0.197	0.161	0.276	0.106	0.028	0.067	0.043	0.008	
	Min	0.047	0.0059	0.177	0.142	0.252	0.091	0.02	0.051	0.02		

DBS

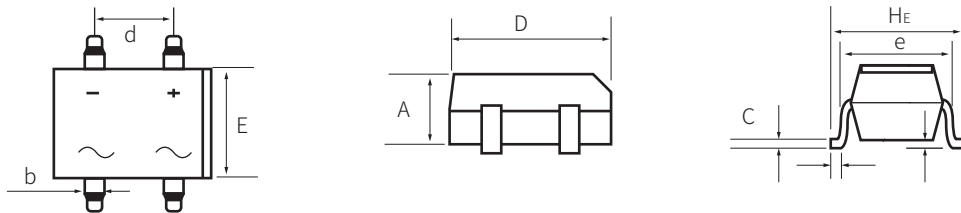

Symbol		A	b	C	D	d	E	e	H _E
mm	Min	2.1	0.9	0.15	7.95	5	6.1	7.4	9.6
	Max	2.5	1.1	0.25	8.35	5.2	6.5	7.9	10.2

SOT-353

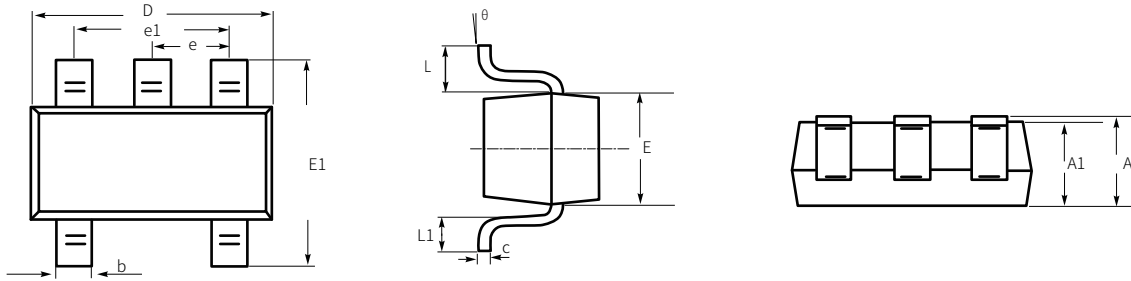

Symbol		A	A1	b	c	D	E	E1	e	e1	L	L1	θ
mm	Max	1.1	1	0.35	0.15	2.2	1.35	2.45	0.65 TYP	1.4	0.525 REF	0.46	8°
	Min	0.9	0.9	0.15	0.08	2	1.15	2.15		1.2		0.26	0°
Inches	Max	0.043	0.039	0.014	0.006	0.087	0.053	0.096	0.026 TYP	0.055	0.021 REF	0.018	8°
	Min	0.035	0.035	0.006	0.003	0.079	0.045	0.085		0.047		0.01	0°

SOT23-5

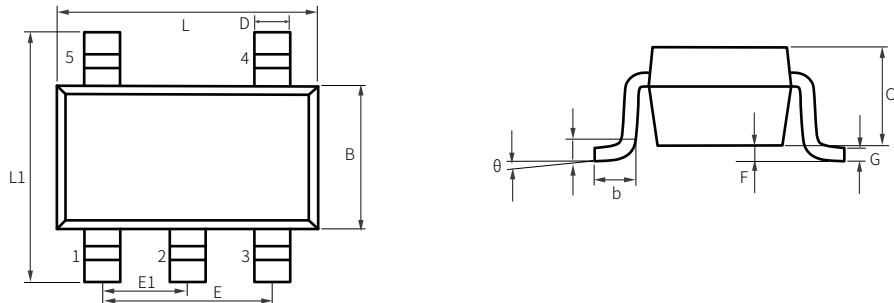

Symbol		L	B	C	L1	E	E1	D	G	b	F	θ
mm	Max	3.02	1.7	1.3	3	2	1.05	0.5	0.2	0.55	0.15	8°
	Min	2.82	1.5	0.9	2.6	1.8	0.85	0.35	0.1	0.35	0	0°

SOT-363

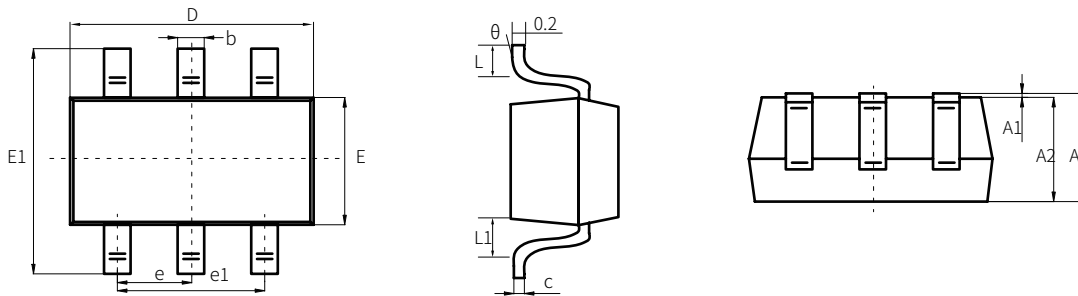

Symbol		A	A1	A2	b	c	D	E	E1	e	e1	L	L1	θ
mm	Max	1.1	0.1	1	0.35	0.15	2.2	1.35	2.45	0.65 TYP.	1.4	0.525 REF	0.46	8°
	Min	0.9		0.9	0.15	0.08	2	1.15	2.15		1.2		0.26	0°

SOT23-6

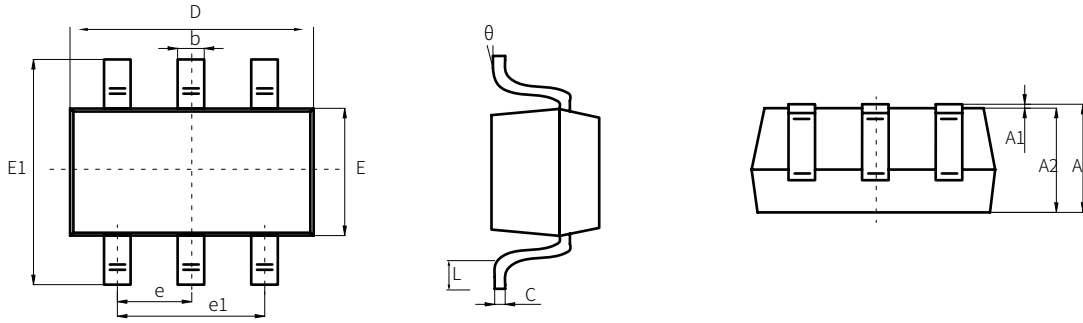

Symbol		A	A1	A2	b	c	D	E	E1	e	e1	L	θ
mm	Max	1.25	0.1	1.15	0.5	0.2	3.02	1.7	2.95	0.95 (BSC)	2	0.6	8°
	Min	1.05		1.05	0.3	0.1	2.82	1.5	2.65		1.8	0.3	0°
Inches	Max	0.049	0.004	0.045	0.02	0.008	0.119	0.067	0.116	0.037 (BSC)	0.079	0.024	8°
	Min	0.041		0.041	0.012	0.004	0.111	0.059	0.104		0.071	0.012	0°

TSSOP-8

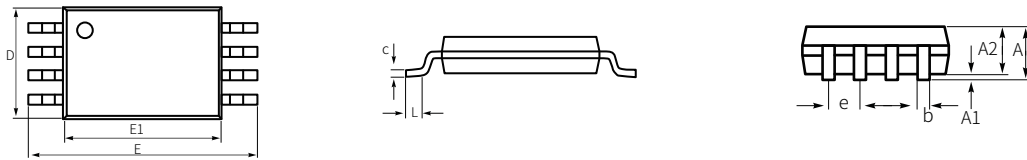

Symbol		A	A1	A2	D	E	E1	L	b	c	e
mm	Max	1.2	0.15	1.05	3.1	6.6	4.5	0.75	0.3	0.2	0.65 (BSC)
	Min			0.85	2.9	6.2	4.3	0.45	0.19	0.09	

SOP-8

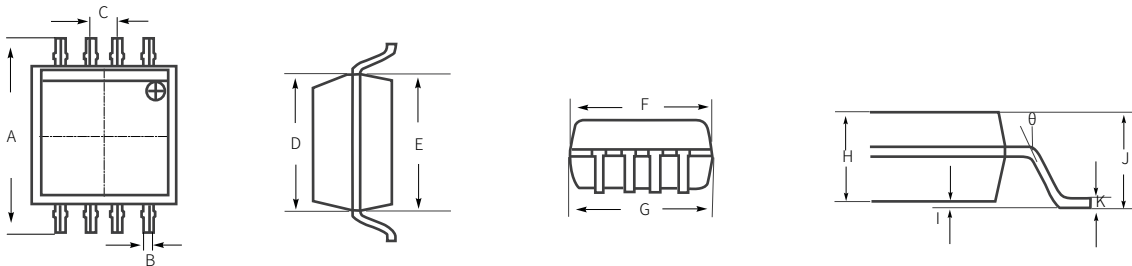

Symbol		A	B	C	D	E	F	G	H	I	J	K	θ
mm	Max	6.15	0.43	1.32	3.9	3.95	4.9	4.95	1.45	0.21	1.71	0.25	8°
	Min	5.85	0.37	1.22	3.8	3.85	4.8	4.85		0.11	1.61	0.19	0°

MEMS

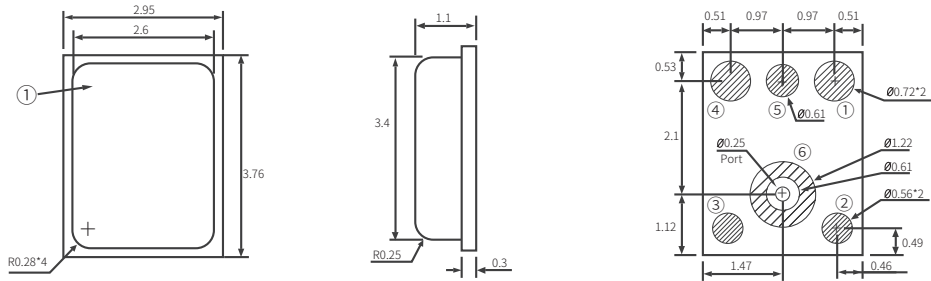

Items	Size	Tolerance	Symbol
Length	3.76	± 0.1	mm
Width	2.95	± 0.1	mm
Height	1.1	± 0.1	mm
Acousticport	$\Phi 0.25$	± 0.076	mm

PDFN5060-8

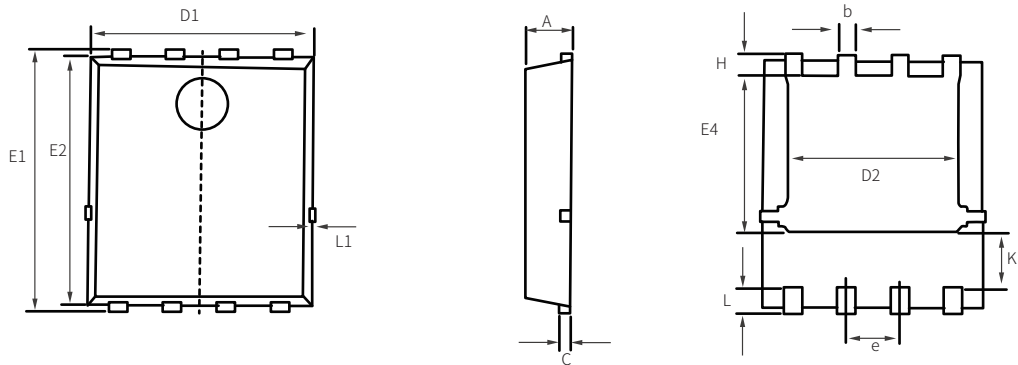

Symbol	mm	
	Min	Max
A	1	1.2
b	0.3	0.5
C	0.154	0.354
D1	5	5.4
D2	3.8	4.25
E1	5.95	6.35
E2	5.66	6.06
E4	3.52	3.92
e	1.07	1.37
L	0.3	0.7
L1		0.12
H	0.4	0.6
K	1.15	1.45

DFN2510

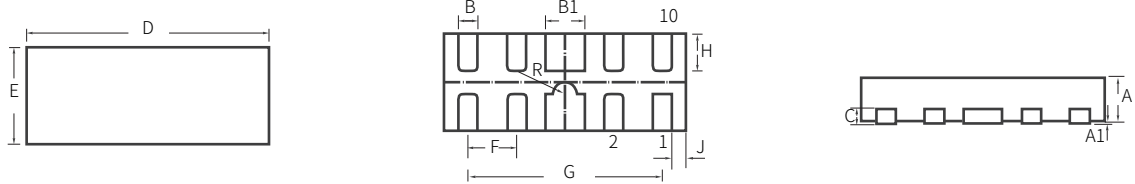

Symbol		A	A1	B	B1	C	D	E	F	G	H	R	J
mm	Max	0.5	0.05	0.25	0.45	0.2	2.55	1.05	0.5 (BSC)	2 (BSC)	0.46	0.125 (BSC)	0.2
	Nom	0.45	0.02	0.2	0.4	0.15	2.5	1			0.38		0.15
	Min	0.4	--	0.15	0.35	0.1	2.45	0.95			0.3		0.1

DFN2*2-6

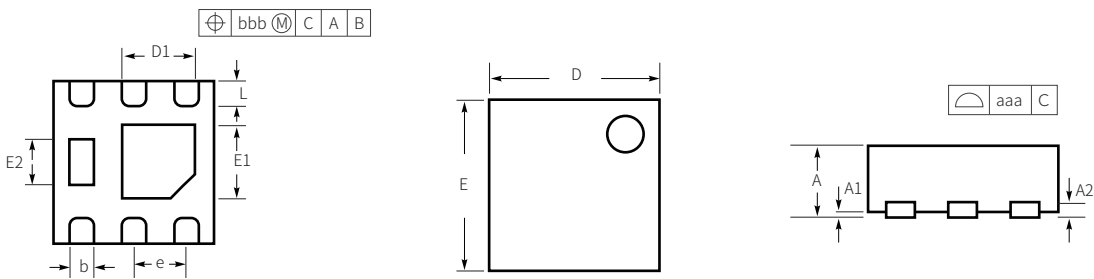

Symbol	mm		
	Min	Typ	Max
A	0.6	0.65	0.7
A1	0.01	0.03	0.05
A2	0.152REF		
b	0.25	0.3	0.35
D	1.95	2	2.05
D1	0.9	0.95	1
E	1.95	2	2.05
E1	1.1	1.15	1.2
E2	0.6	0.65	0.65
L	0.23	0.28	0.33
e	0.65TYP		

DFN2*2

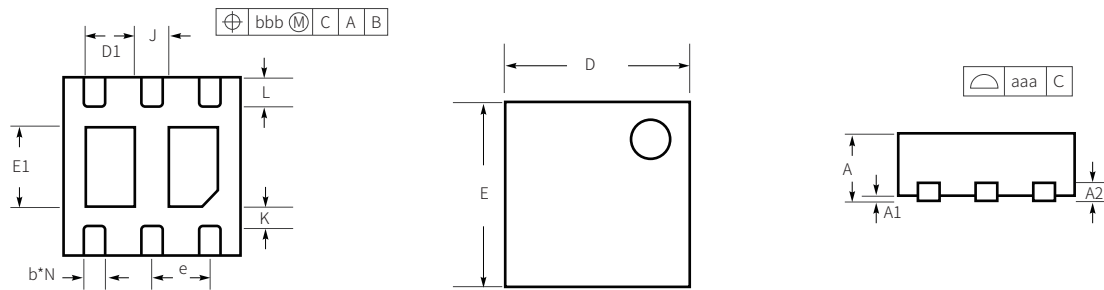

Symbol	mm		
	Min	Typ	Max
A	0.7	0.75	0.8
A1	0	0.02	0.05
A2	0.203	0.203	0.203
b	0.2	0.25	0.3
D	1.95	2	2.05
D1	0.5	0.55	0.6
E	1.95	2	2.05
E1	0.85	0.9	0.95
e		0.65	
L	0.27	0.32	0.37
J		0.4	
K		0.2	
N		6	
aaa		0.08	
bbb		0.1	

DFN3.3*3.3

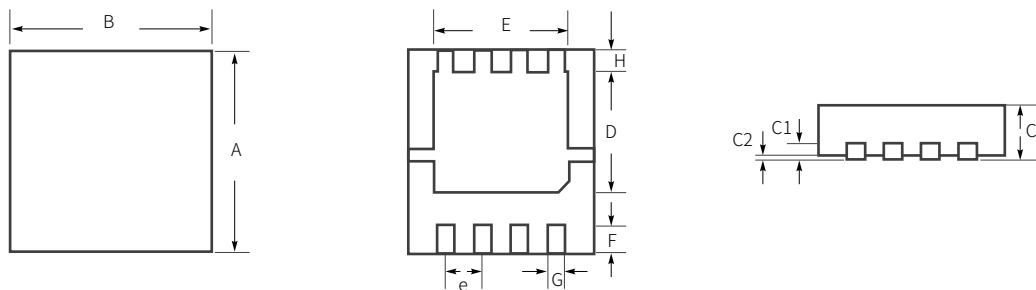

Symbol		A	B	C	C1	C2	D	E	F	G	H	e
mm	Max	3.3	3.3	0.85	0.22	0.05	2	2.45	0.5	0.35	0.4	0.7
	Min	3.2	3.2	0.75	0.18	0.05	1.8	2.2	0.4	0.25	0.3	0.6

DFN3*3A-8

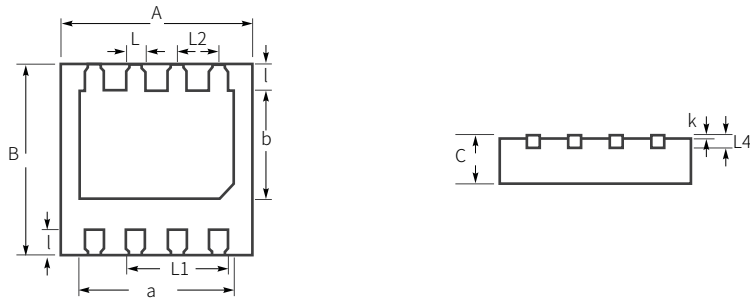

Symbol		A	B	C	L	L1	L2	L4	a	b	k	l
mm	Max	3.1	3.1	0.8	0.35	1.65		0.21	2.5	1.8	0.05	0.45
	Typ	3	3	0.75	0.3	1.6	0.65	0.2	2.4	1.7		0.4
	Min	2.9	2.9	0.7	0.25	1.55		0.19	2.3	1.6	0	0.35

PRPAK5X6

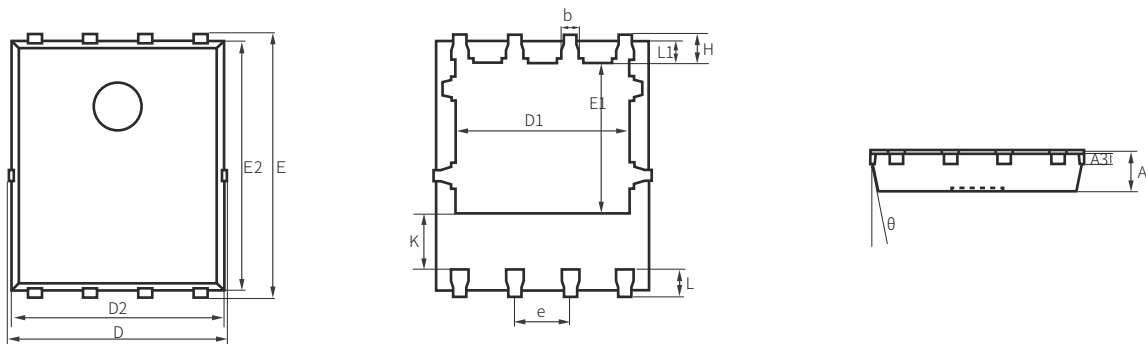

Symbol	mm		Inches	
	Max	Min	Max	Min
A	1	0.9	0.039	0.035
A3	0.254REF.		0.01REF.	
D	5.096	4.944	0.201	0.195
D1	4.11	3.91	0.162	0.154
D2	4.976	4.824	0.196	0.19
E	6.126	5.974	0.241	0.235
E1	3.575	3.375	0.141	0.133
E2	5.826	5.674	0.229	0.223
k	1.39	1.19	0.055	0.047
b	0.45	0.35	0.018	0.014
e	1.27TYP.		0.05TYP.	
L	0.711	0.559	0.028	0.022
L1	0.576	0.424	0.023	0.017
H	0.726	0.574	0.029	0.023
θ	12°	10°	12°	10°

TO-220F

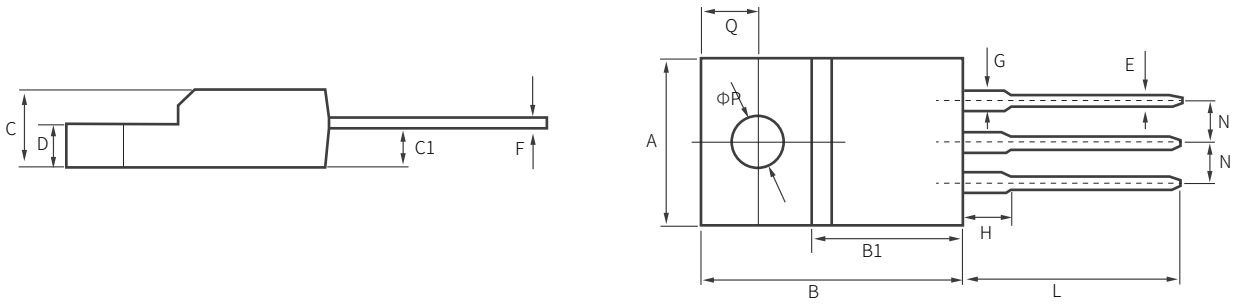

Symbol		A	B	B1	C	C1	D	E	F	G	H	L	N	Q	ΦP
mm	Max	10.3	16.1	9.39	4.8	2.55	2.9	0.9	0.6	1.42	3.8	13.6	2.74	3.55	3.3
	Min	9.7	15.5	8.99	4.4	2.15	2.5	0.7	0.4	1.12	3.4	12.6	2.34	3.15	3

TO-220

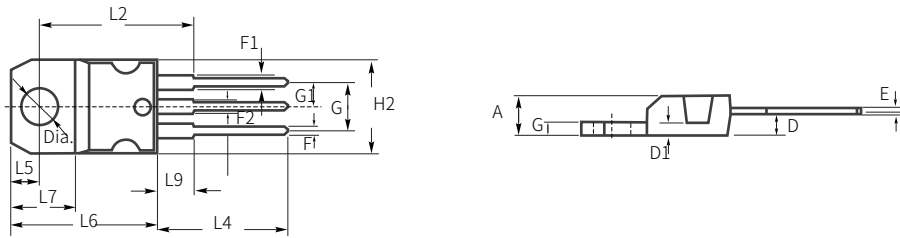

Symbol	mm			Inches		
	Max	Nom	Min	Max	Nom	Min
A	4.6		4.4	0.181		0.173
C	1.32		1.23	0.051		0.048
D	2.72		2.4	0.107		0.094
D1		1.27			0.05	
E	0.7		0.49	0.027		0.019
F	0.88		0.61	0.034		0.024
F1	1.7		1.14	0.067		0.044
F2	1.7		1.14	0.067		0.044
G	5.15		4.95	0.203		0.194
G1	2.7		2.4	0.106		0.094
H2	10.4		10	0.409		0.393
L2		16.4			0.645	
L4	14		13	0.551		0.511
L5	2.95		2.65	0.116		0.104
L6	15.75		15.25	0.62		0.6
L7	6.6		6.2	0.26		0.244
L9	3.93		3.5	1.54		0.137
DIA.	3.85		3.75	1.51		0.147

TO-3PNB

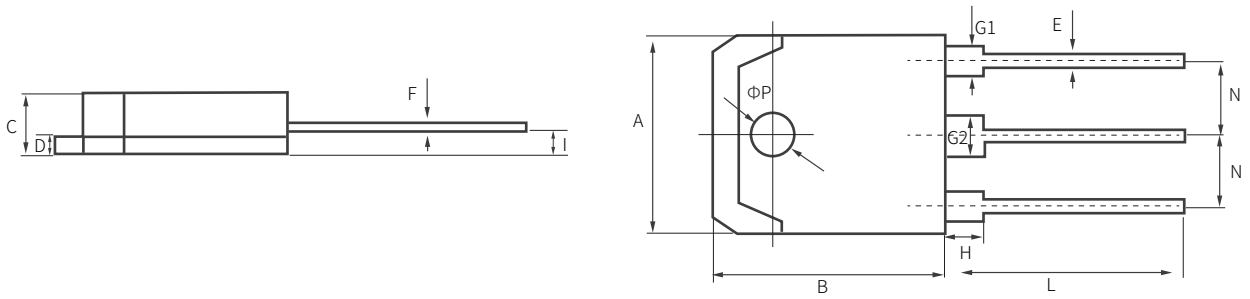

Symbol		A	B	C	D	E	F	G1	G2	H	I	L	N	ΦP
mm	Max	15.9	20.5	4.9	1.6	1.1	0.7	2.2	3.2	3.6	1.6	20.9	5.65	3.3
	Min	15.1	19.5	4.7	1.4	0.9	0.5	2	3	3	1.4	19.5	5.25	3.1

TO-247

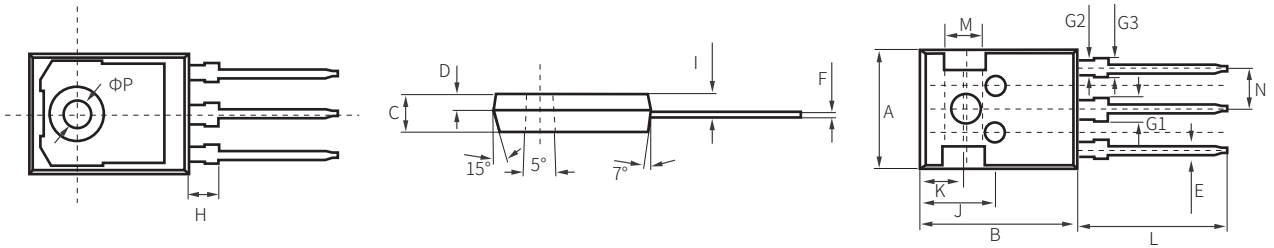

Symbol	mm	
	Max	Min
A	15.9	15.7
B	21.1	20.9
C	5.1	4.9
D	2.1	1.9
E	1.3	1.1
F	0.75	0.45
G1	3.2	3
G2	2.15	1.85
G3	2.2	2
H	4.3	4
I	2.5	2.3
J	10.1	9.9
K	5.9	5.7
L	20.2	19.8
M	5.15	4.85
N	5.586	5.286
ΦP	3.6	3.4

KBP

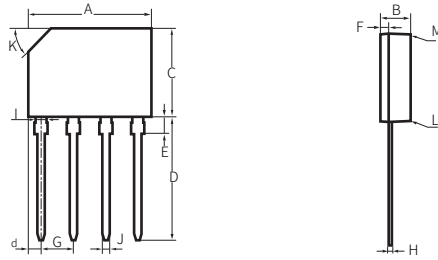

Symbol		A	B	C	D	d	E	F	G	H	I	J	K	L	M
mm	Max	14.25	3.35	10.20	14.25	1.40	1.80	0.80	3.56	0.35	1.22	0.76	2.7*45° (TYP)		
	Min	14.75	3.65	10.60	14.73	1.70	2.20	1.10	4.06	0.55	1.42	0.86		3°	2°

KBL

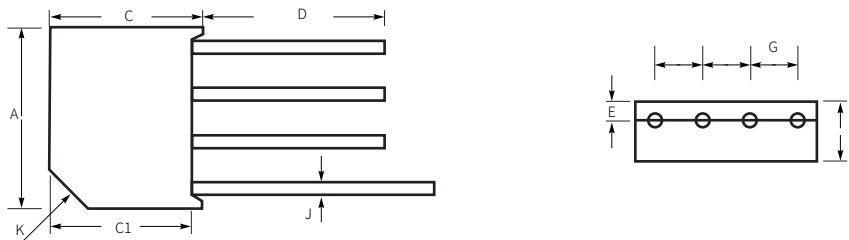

Symbol		A	B	C	C1	D	E	J	G	K
mm	Max	19.5	6.5	16.3	14.9	15	2	1.3	5.6	4*45°
	Min	18.5	5.5	15.2	13.9	15	1.6	1.2	4.6	
Inches	Max	0.768	0.256	0.64	0.587	0.59	0.079	0.052	0.22	0.157*45°
	Min	0.762	0.217	0.6	0.547	0.59	0.063	0.048	0.18	

GBU

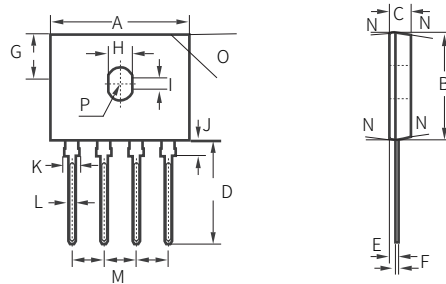

Symbol		A	B	C	D	E	F	G	H	I	J	K	L	M	N	O	P
mm	Max	22.3	18.8	3.56	18	1	0.56	7.9	4.1	2.16	2.75	2.35	1.27	5.33	7.0° TYP	3.2* 45°	1.9 RADIUS
	Min	21.8	18.3	3.30	17.5	0.76	0.46	7.4	3.5	1.65	1.85	1.95	1.02	4.83			
Inches	Max	0.878	0.74	0.14	0.709	0.039	0.022	0.311	0.161	0.085	0.108	0.093	0.05	0.21	7.0° TYP	126* 45°	75 RADIUS
	Min	0.858	0.72	0.13	0.689	0.03	0.018	0.291	0.138	0.065	0.073	0.077	0.04	0.19			

GBJ

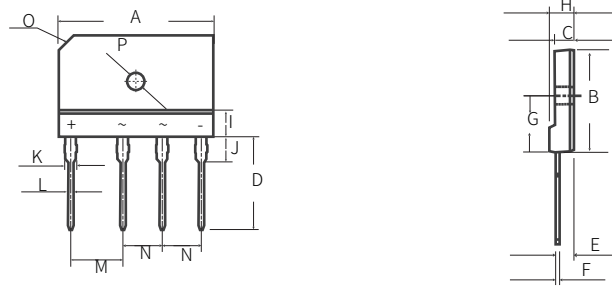

Symbol		A	B	C	D	E	F	G	H	I	J	K	L	M	N	O	P
mm	Max	30.3	20.3	3.8	18	2.9	0.8	7.9	4.8	5.8	4.2	2.4	1.15	10.2	7.7	C3	Φ3.6
	Min	29.7	19.7	3.4	17	2.5	0.55	7.4	4.4	4.8	3.8	2	0.9	9.8	7.3		Φ3
Inches	Max	1.193	0.799	0.15	0.709	0.114	0.031	0.311	0.189	0.228	0.165	0.094	0.045	0.402	0.303	C118	Φ142
	Min	1.169	0.776	0.134	0.669	0.098	0.022	0.291	0.173	0.189	0.15	0.079	0.035	0.386	0.287		Φ118

SGBJ

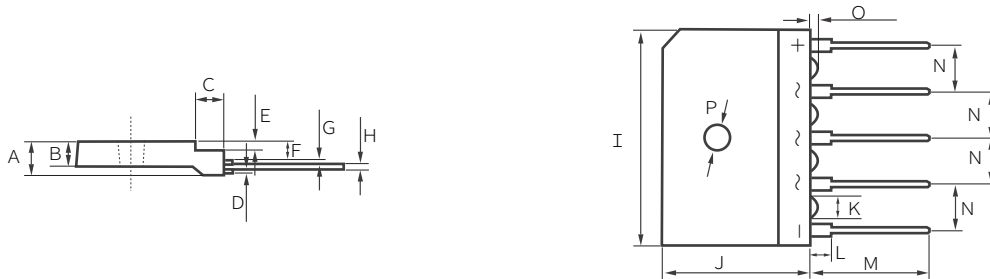

Symbol	mm		Inches	
	Max	Min	Max	Min
A	5.6	5.4	0.221	0.213
B	4.1	3.9	0.162	0.154
C	4.75	4.65	0.187	0.183
D	0.55	0.45	0.022	0.018
E	1.35	1.25	0.053	0.049
F	3.9	3.7	0.154	0.146
G	0.85	0.75	0.033	0.03
H	0.8	0.6	0.031	0.024
I	35.3	34.7	1.391	1.367
J	25.2	24.8	0.993	0.977
K	3.55	3.45	0.14	0.136
L	3.8	3.7	0.15	0.146
M	20.5	20.3	0.808	0.8
N	7.6	7.4	0.299	0.291
O	1.55	1.45	0.61	0.57
P	3.55	3.45	0.14	0.136

CERTIFIED
獲得認證



關注時科微信
Follow SHIKUES Wechat



關注時科抖音
Follow SHIKUES Tik Tok

地址及聯絡方式 Address and Contact Information

廣東時科微實業有限公司
Guangdong SHIKUES Micro Industrial Co.,Ltd.
臺灣時科電子股份有限公司
Taiwan SHIKUES Electronic Holdings Limited

供應鏈中心: 深圳市龍崗區坂田街道天安雲谷二期11棟2610-3,2611-4
Supply Chain Center Add.: Room 2610-3,2611-4, Building 11, TiananYungu II,
Bantian Street, Longgang District, Shenzhen

運營中心: 深圳市龍崗區坂田街道天安雲谷二期11棟2608-1, 2609-2
Operation Center Add.: Room 2608-1, 2609-2, Building 11, TiananYungu II,
Bantian Street, Longgang District, Shenzhen

北京辦地址: 北京市房山區長陽鎮熙悅廣場9號樓508
Beijing Office Add.: Room 508, Building 9, Xiyue Plaza, Changyang Town,
Fangshan District, Beijing

更多詳情歡迎訪問 www.shikues.com 或 www.s-k.tw
For more details, please visit www.shikues.com
or www.s-k.tw

或直接撥打 400-662-3488
or call 400-662-3488
監督投訴郵箱: gm@shikues.com