

## Designated client product

This product will be discontinued its production in the near term.  
And it is provided for customers currently in use only, with a time limit.  
It can not be available for your new project. Please select other new or existing products.

For more information, please contact our sales office in your region.

New Japan Radio Co.,Ltd.



[www.njr.com](http://www.njr.com)



## DUAL OPERATIONAL TRANSCONDUCTANCE AMPLIFIER

### ■ GENERAL DESCRIPTION

The NJM13600/13700 consist of two current controlled trans conductance amplifiers each with differential inputs and a push pull output. The two amplifiers share common supplies but otherwise operate independently. Linearizing diodes are provided at the inputs to reduce distortion and allow higher input levels. The result is a 10 dB signal-to-noise improvement referenced to 0.5 percent THD. Controlled impedance buffers are provided which are especially designed to complement the dynamic range of the amplifiers.

### ■ PACKAGE OUTLINE

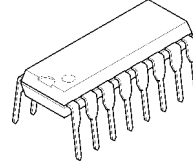

NJM13600D  
NJM13700D

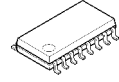

NJM13600M  
NJM13700M

### ■ FEATURES

- Package Outline DIP16, DMP16
- Bipolar Technology

### ■ PIN CONFIGURATION

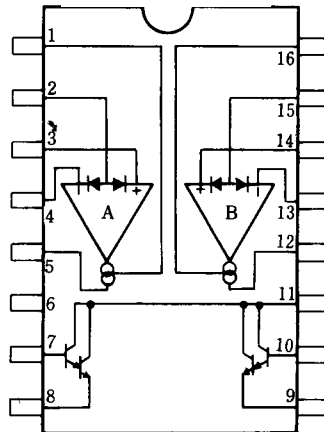

NJM13600D, NJM13600M  
NJM13700D, NJM13700M

### PIN FUNCTION

- |                     |                      |
|---------------------|----------------------|
| 1. AMP BIAS INPUT A | 9. BUFFER OUTPUT B   |
| 2. DIODE BIAS A     | 10. BUFFER INPUT B   |
| 3. +INPUT           | 11. V <sup>+</sup>   |
| 4. -INPUT           | 12. OUTPUT B         |
| 5. OUTPUT A         | 13. -INPUT B         |
| 6. V <sup>-</sup>   | 14. +INPUT B         |
| 7. BUFFER INPUT A   | 15. DIODE BIAS B     |
| 8. BUFFER OUTPUT A  | 16. AMP BIAS INPUT B |

### ■ EQUIVALENT CIRCUIT

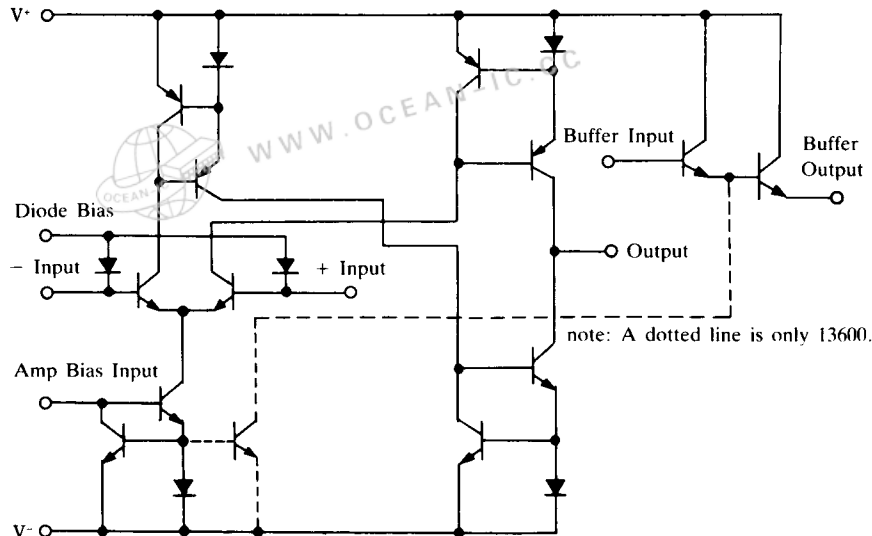

# NJM13600/13700

## ■ ABSOLUTE MAXIMUM RATINGS

(Ta=25°C)

PARAMETER	SYMBOL	RATINGS	UNIT
Supply Voltage	V <sup>+</sup> /V	36 or ±18	V
Differential Input Voltage	V <sub>ID</sub>	±5	V
Diode Bias Current	I <sub>D</sub>	2	mA
Amp Bias Current	I <sub>ABC</sub>	2	mA
Buffer Output Current	I <sub>O</sub>	20	mA
Power Dissipation	P <sub>D</sub>	(DIP16) 570 (DMP16) 700 (note)	mW
DC Input Voltage	V <sub>IN</sub>	V <sup>+</sup> ~V	V
Operating Temperature Range	T <sub>opr</sub>	-40~+85	°C
Storage Temperature Range	T <sub>stg</sub>	-40~+125	°C

(note) At on a ceramic PCB (10x20x0.635 mm)

## ■ ELECTRICAL CHARACTERISTICS

(V<sup>+</sup>/V=±15V, Ta=25°C, I<sub>ABC</sub>=500μA)

PARAMETER	SYMBOL	TEST CONDITION	13600			13700			UNIT
			MIN.	TYP.	MAX.	MIN.	TYP.	MAX.	
Input Offset Voltage (V <sub>OS</sub> )	V <sub>IO</sub>		-	0.4	5	-	0.4	4	mV
Input Offset Voltage		I <sub>ABC</sub> =5μA	-	0.3	5	-	0.3	4	mV
V <sub>OS</sub> Including Diodes		Diode Bias Current, I <sub>D</sub> =500μA	-	0.5	5	-	0.5	5	mV
Input Offset Change		5μA ≤ I <sub>ABC</sub> ≤ 500μA	-	0.1	-	-	0.1	3	mV
Input Bias Current	I <sub>B</sub>		-	0.4	5	-	0.4	5	μA
Input Bias Current		(-20~+75°C)	-	1	8	-	1	8	μA
Forward Transconductance	gm		6700	9600	13000	6700	9600	13000	μS
		(-20~+75°C)	5400	-	-	5400	-	-	μS
gm Tracking		R <sub>L</sub> =0, I <sub>ABC</sub> =5μA	-	0.3	-	-	0.3	-	dB
Peak Output Current	I <sub>OP</sub>	R <sub>L</sub> =0, I <sub>ABC</sub> =5μA	-	5	-	-	0	-	μA
Peak Output Current		R <sub>L</sub> =0, I <sub>ABC</sub> =500μA	350	500	650	350	500	650	μA
Peak Output Current		R <sub>L</sub> =0 (-20~+75°C)	300	-	-	300	-	-	μA
Peak Output Voltage Positive	V <sub>OP</sub>	R <sub>L</sub> =∞, 5μA ≤ I <sub>ABC</sub> ≤ 500μA	+12	+14.2	-	+12	+14.2	-	V
Peak Output Voltage Negative		R <sub>L</sub> =∞, 5μA ≤ I <sub>ABC</sub> ≤ 500μA	-12	-14.4	-	-12	-14.4	-	V
Operating Current	I <sub>CC</sub>	I <sub>ABC</sub> =500μA, two circuit	-	2.6	-	-	2.6	-	mA
V <sub>OS</sub> Sensitivity Positive	SVR	ΔV <sub>OS</sub> /ΔV <sup>+</sup>	76.5	94	-	76.5	94	-	dB
V <sub>OS</sub> Sensitivity Negative		ΔV <sub>OS</sub> /ΔV <sup>-</sup>	76.5	94	-	76.5	94	-	dB
Input Offset Current	I <sub>IO</sub>		-	0.1	0.6	-	0.1	0.6	μA
CMRR	CMR		80	110	-	80	110	-	dB
Common Mode Range	V <sub>ICM</sub>		±12	±13.5	-	±12	±13.5	-	V
Cross Talk	CT	20Hz < f < 20kHz (note2)	-	-100	-	-	-100	-	dB
Differential Input Current	I <sub>ID</sub>	I <sub>ABC</sub> =0, Input=±4V	-	0.02	100	-	0.02	100	nA
Leakage Current	I <sub>LEAK</sub>	I <sub>ABC</sub> =0(Refer to Test Circuit)	-	0.2	100	-	0.2	100	nA
Input Resistance	R <sub>IN</sub>		10	26	-	10	26	-	kΩ
Open Loop Bandwidth			-	2	-	-	2	-	MHz
Slew Rate	SR		-	50	-	-	50	-	V/μs
Buffer Input Current		(note2)	-	0.4	5	-	0.4	5	μA
Peak Buffer Output Voltage		(note2)	10	-	-	10	-	-	V

(note1) Open unless otherwise specified. The inputs to the buffers are grounded and outputs are open.

(note2) R<sub>OUT</sub>=5kΩ connected from the buffer output to V<sup>+</sup> and the input of buffer is connected to the transconductance amplifier output.

I<sub>ABC</sub>=500μA

## ■ TEST CIRCUIT

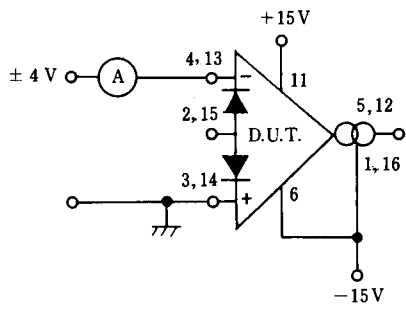

Differential Input Current

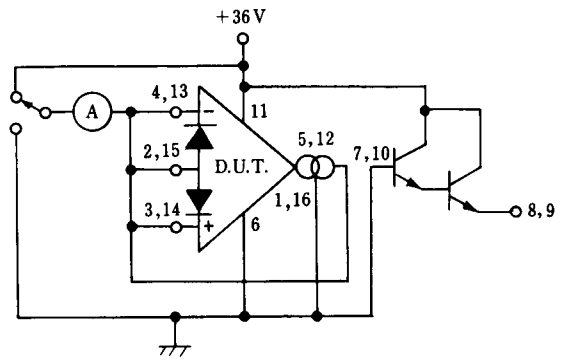

Leakage Current

## ■ TYPICAL APPLICATIONS

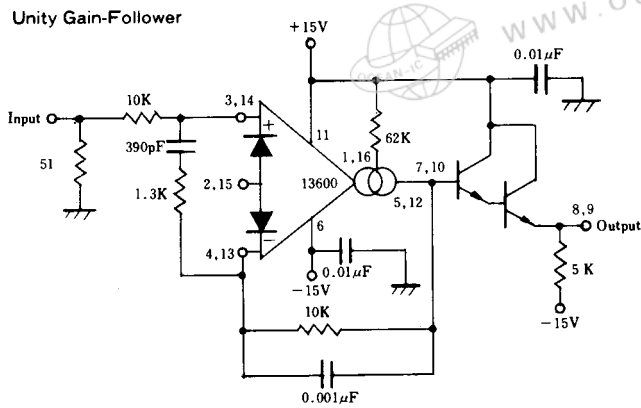

WWW.OCEAN-IC.CC

## ■ TYPICAL CHARACTERISTICS

**Distortion vs. Differential Input Voltage**

( $V^+/V^- = \pm 15V$ ,  $R_L = 10k\Omega$ ,  $I_{ABC} = 1mA$ ,  $T_a = 25^\circ C$ )

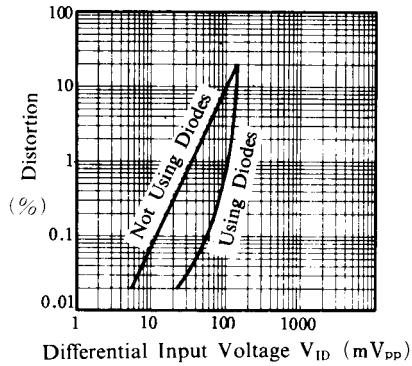

**Voltage vs. Amplifier Bias Current**

( $V^+/V^- = \pm 15V$ ,  $R_L = 10k\Omega$ ,  $T_a = 25^\circ C$ )

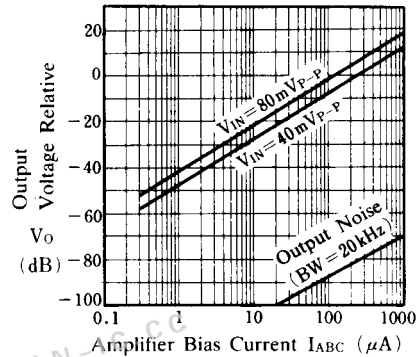

**Output Noise Current vs. Frequency**

( $T_a = 25^\circ C$ )

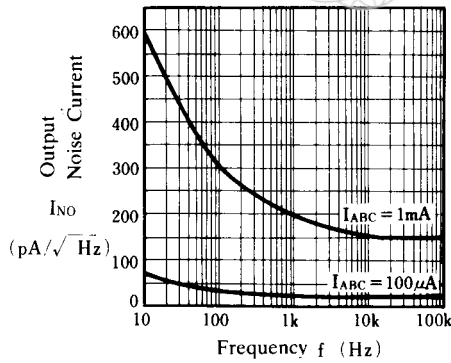

WWW.OCEAN-IC.CC

## ■ TYPICAL CHARACTERISTICS

**Input Offset Voltage**

( $V^+/V^- = \pm 15V$ ,  $T_a = 25^\circ C$ )

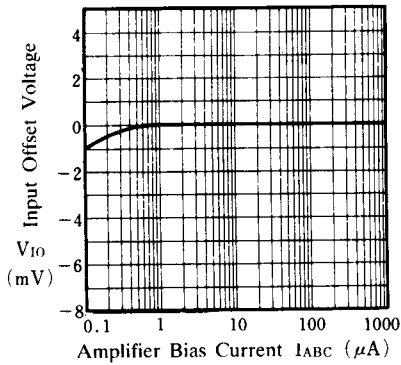

**Input Offset Current**

( $V^+/V^- = \pm 15V$ ,  $T_a = 25^\circ C$ )

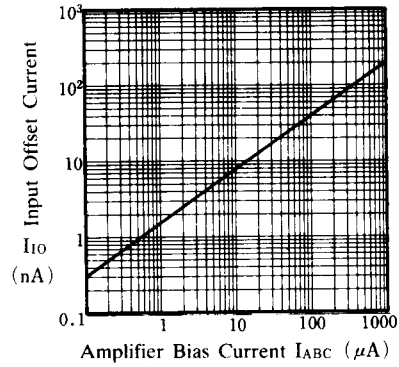

**Input Bias Current**

( $V^+/V^- = \pm 15V$ ,  $T_a = 25^\circ C$ )

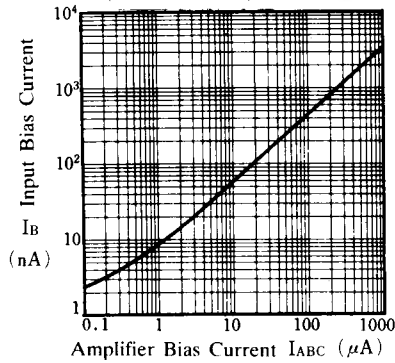

**Peak Output Current**

( $V^+/V^- = \pm 15V$ ,  $T_a = 25^\circ C$ )

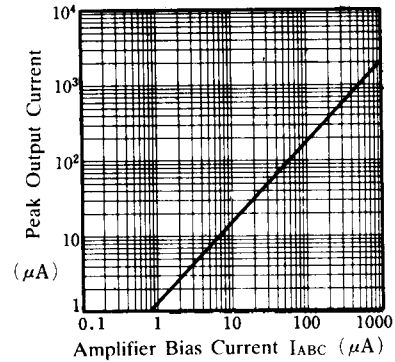

**Peak Output Voltage and Common Mode Range**

( $V^+/V^- = \pm 15V$ ,  $R_L = \infty$ ,  $T_a = 25^\circ C$ )

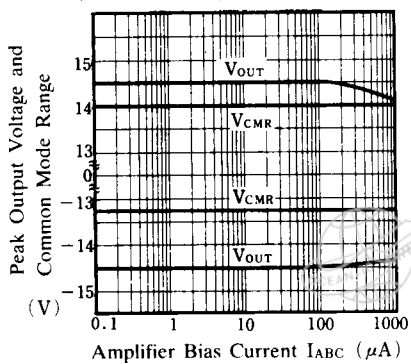

**Leakage Current vs. Temperature**

( $+V_{IN} = -V_{IN} = V_O$ )

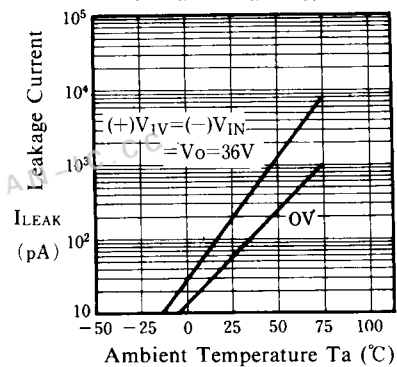

# NJM13600/13700

## ■ TYPICAL CHARACTERISTICS

**Input Leakage Current**  
( $T_a = 25^\circ\text{C}$ )

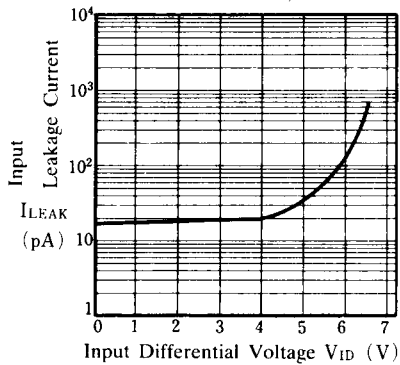

**Transconductance**

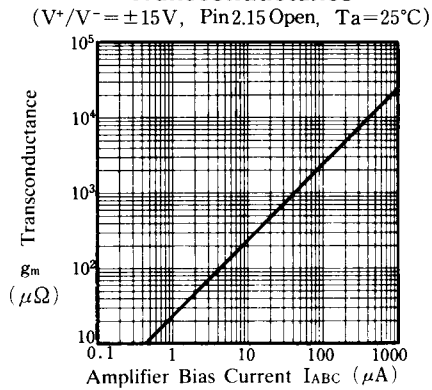

**Input Resistance**

(Pin2.15 Open,  $T_a = 25^\circ\text{C}$ )

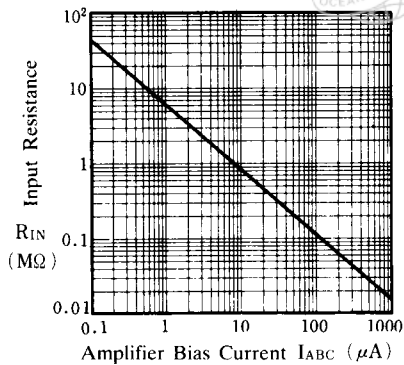

**Amplifier Bias Voltage**

**vs. Amplifier Bias Current**

( $T_a = 25^\circ\text{C}$ )

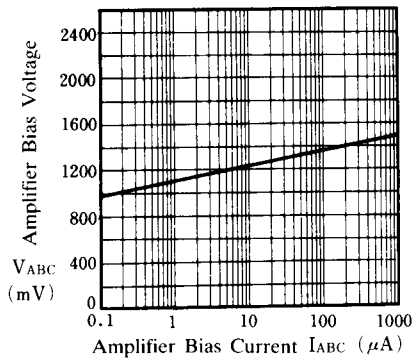

**Input and Output Capacitance**

( $V^+/V^- = \pm 15\text{V}$ ,  $T_a = 25^\circ\text{C}$ )

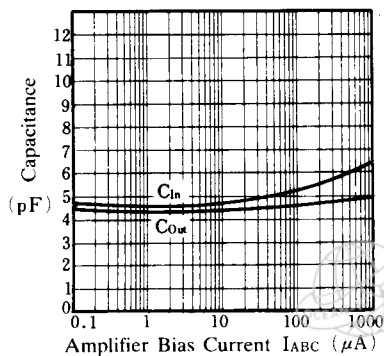

**Output Resistance**

( $T_a = 25^\circ\text{C}$ )

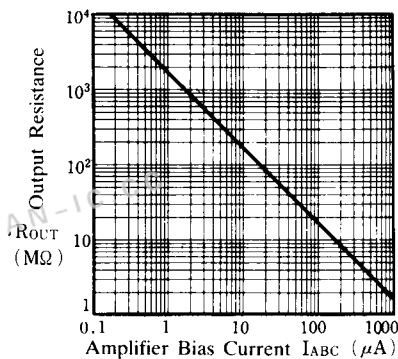

**[CAUTION]**

The specifications on this databook are only given for information, without any guarantee as regards either mistakes or omissions. The application circuits in this databook are described only to show representative usages of the product and not intended for the guarantee or permission of any right including the industrial rights.