

# 产品规格书

## SPECIFICATION

产品名称 Name. NO: 2012单体红蓝双色 Bi-color Red and Blue 1.1T

产品型号 Model. NO: KTR-2012SURSUBC-1.1

文件编号 Document.NO:

版次 REV. NO: K4.0

描述 Description:

- 2.0×1.2×1.1mmmm贴片发光二极管2.0×1.2×1.1mmmm Chip SMD
- 胶体颜色Colloid Color: 无色透明 Water Transparent
- 发光颜色Emission Color: 红蓝 Red and Blue
- 半功率角度Viewing Angle :120°

深圳市科特翎科技有限公司 SHENZHEN KETERINE TECHNOLOGY CO., LTD.			
编制 Prepared by	审核 Checked by	核准 Approved by	市场部 Market Dept.

客户确认 CUSTOMER CONFIRMATION			
确认 Confirmed by	审核 Checked by	核准 Approved by	确认 Confirmed by

## 1. 外形尺寸Dimensions

单位(Units):毫米(mm)

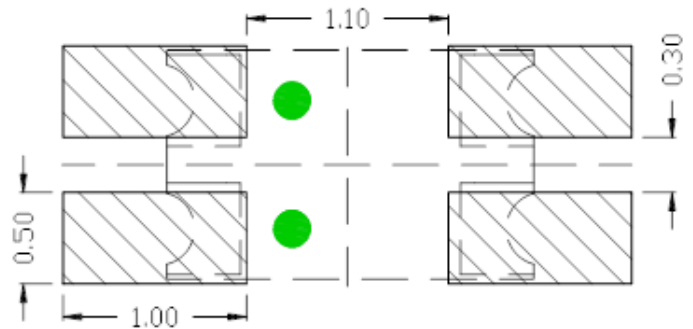
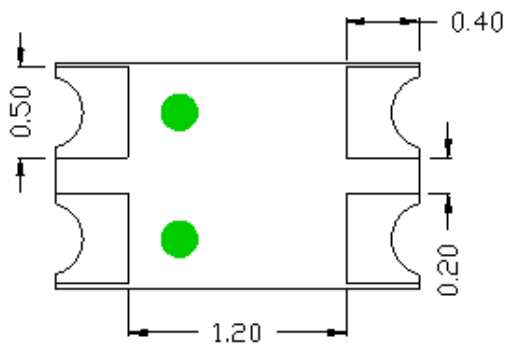
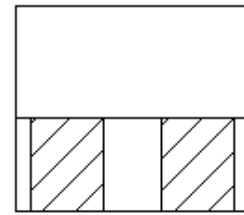
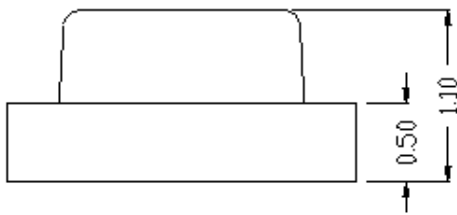
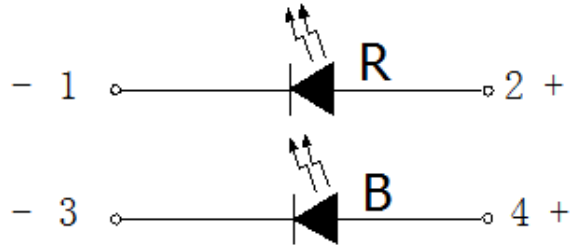
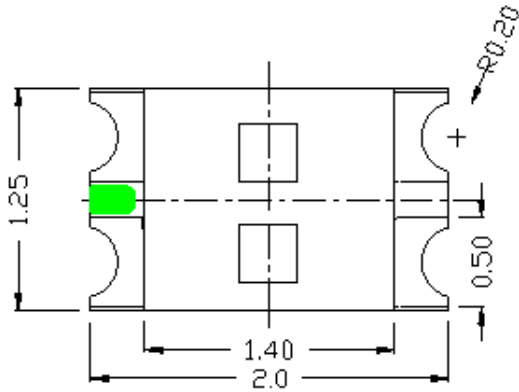

### 注意:

所有尺寸单位为mm，如无特殊说明误差范围为 $\pm 0.1\text{mm}$

All dimensions area in mm tolerance is  $\pm 0.1\text{mm}$  unless otherwise noted.

## 2. 光电特性Electrical / Optical characteristics

(1) 最大限度值Absolute Maximum Ratings (TA=25±5°C)

项目Items	符号Symbol	最大额定值Absolute maximum Rating		单位Unit
		红光Red	蓝光Blue	
功率消耗Power Dissipation	P <sub>D</sub>	55	80	mW
正向电流Forward Current(DC)	I <sub>F</sub>	25	25	mA
正向峰值电流 Peak Forward Current	I <sub>FP</sub>	70	100	mA
反向电压Reverse Voltage	V <sub>R</sub>	5		V
工作温度Operation Temperature	T <sub>opr</sub>	-30°C To +85°C		°C
贮藏温度Storage Temperature	T <sub>stg</sub>	-40°C To +90°C		°C
焊接温度Soldering Temperature	T <sub>sld</sub>	ReflowSoldering:260°C		for 10sec.

1/10周期, 0.1 msec脉宽

IFP Conditions : 1/10 Duty Cycle, 0.1 msec Pulse Width.

(2) 样品光电参数Initial Electrical/Optical Characteristics (TA=25±5°C)

项目Items	单位Units	测试条件Test Conditions	颜色color	最小值Min.	规格值Typ.	最大值Max.	单位Units
正向电压 Forward Voltage	VF	I <sub>F</sub> =20mA	Red	1.6	---	2.4	V
			Blue	2.6	---	3.4	
反向电流 Reverse Current	IR	V <sub>R</sub> =5V		---	---	1	μA
主波长 Dominant Wavelength	λ <sub>d</sub>	I <sub>F</sub> =20mA	Red	620	---	625	nm
			Blue	460	---	470	
发光强度 Luminous Intensity	I <sub>v</sub>	I <sub>F</sub> =20mA	Red	100	---	150	mcd
			Blue	120	---	180	
发光角度 View Angle	2θ 1/2	I <sub>F</sub> =20mA		---	120	---	Deg

正向电压允许误差± 0.05V Tolerance of measurement of Vf is ±0.05 V.

亮度允许误差± 10% Luminous Intensity Measurement allowance is ± 10%.

## 3. 特性曲线 Characteristic curve

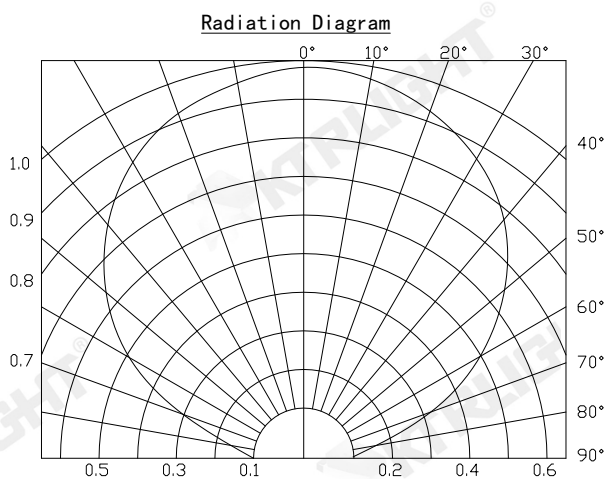
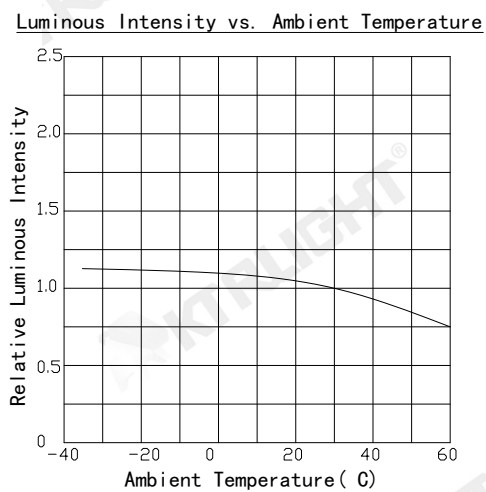
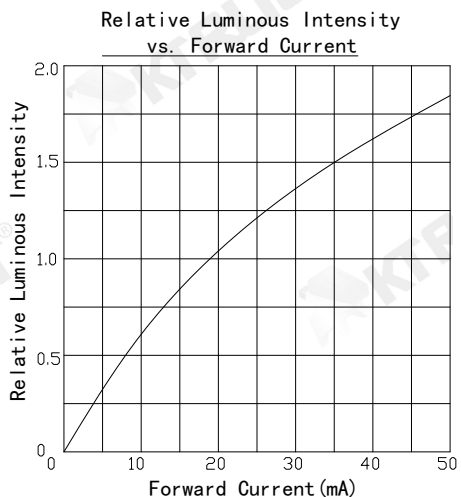
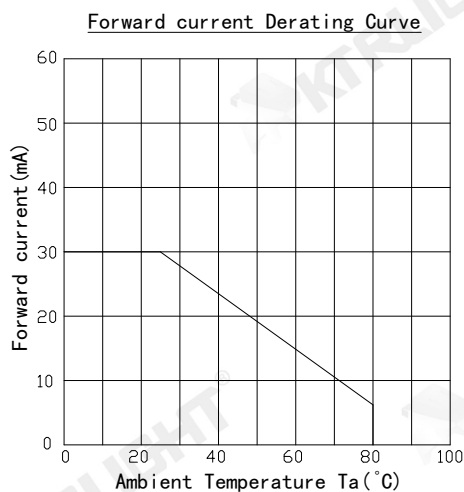
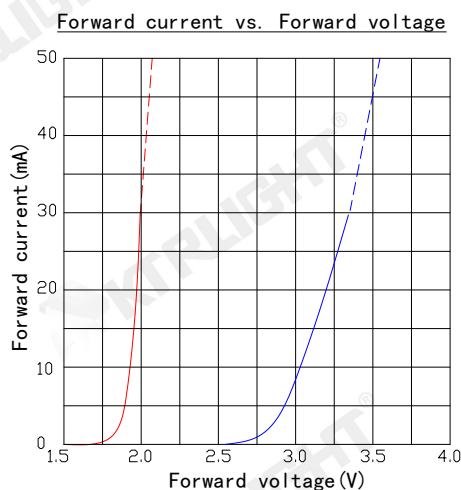
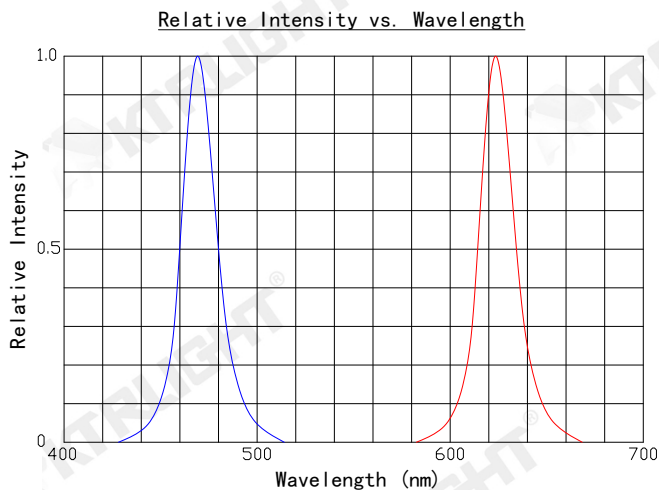

## 4. 可靠性RELIABILITY

### (1)测试项目及结果Test Items and Results

实验项目 Test Items	参考标准 Reference	实验条件 Test Conditions	时间 Time	样品数 Quantity	判据 Criterion
冷热冲击 Thermal Shock	MIL-STD-202G	-40℃(30min)←→100℃(30min)	循环 200 次 200 cycles	22	0/22
湿热循环 Temperature And Humidity Cyclic	JEITA ED-4701 200 203	-10℃——+65℃, 0%-90%RH 24hrs./1cycle	循环 10 次 10 cycles	22	0/22
高温储存 High Temperature Storage	JEITA ED-4701 200 201	Ta=100℃	1000h	22	0/22
低温储存 Low Temperature Storage	JEITA ED-4701 200 202	Ta=-40℃	1000h	22	0/22
高温高湿储存 High Temperature High Humidity Storage	JEITA ED-4701 100 103	Ta=60℃, RH=90%	1000h	22	0/22
常温寿命试验 Life Test	JESD22-A108D	Ta=25℃ IF <sub>R</sub> =20mA,IF <sub>B</sub> =20mA	1000h	22	0/22
高温寿命 High Temperature Life Test	JESD22-A108D	Ta=80℃ IF <sub>R</sub> =20mA,IF <sub>B</sub> =20mA	1000h	22	0/22
低温寿命 Low Temperature Life Test	JESD22-A108D	Ta=-40℃ IF <sub>R</sub> =20mA,IF <sub>B</sub> =20mA	1000h	22	0/22
耐焊接热 Resistance to Soldering Heat	GB/T 4937, II, 2.2&2.3	Tsol*=260℃ 10secs.	2 次 2 times	22	0/22

## 5. 注意事项Cautions

## (1) 焊接条件 Soldering Conditions

本产品最多只可回焊两次,且在首次回焊后须冷却至室温之后方可进行第二次回焊。

Number of reflow process shall be less than 2 times and cooling process to normal temperature is required between first and Second soldering process.

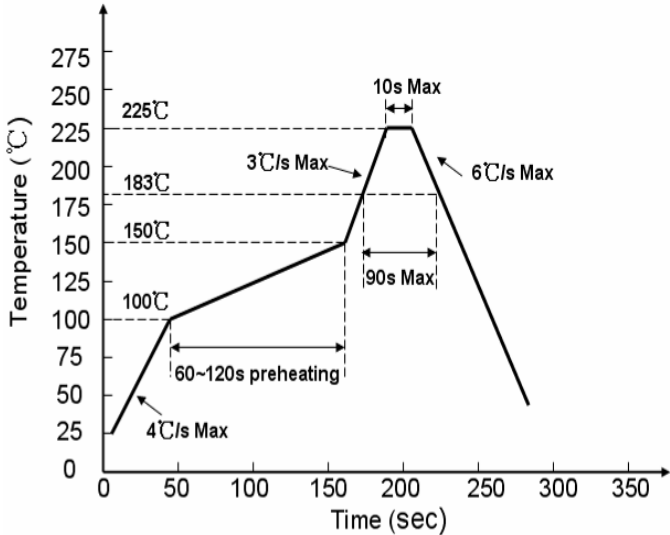

有铅制程

itions)

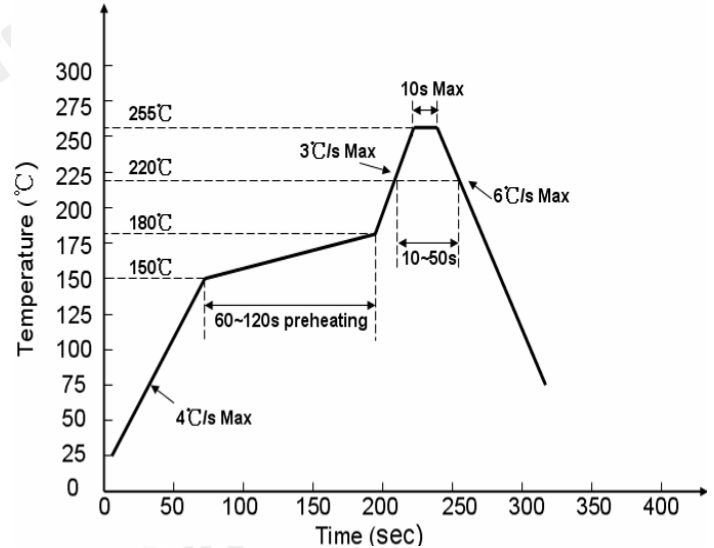

无铅制程

## (2) 防静电措施 ESD countermeasure

静电及高压会对LED造成损坏,特别是晶片材质为绿色和蓝色的产品对静电防护要求更加严格,要求在使用和检验产品时戴防静电手腕带或防静电手套,焊接工具及设备外壳需可靠接地,焊接条件遵循此份规格书中的条件。

Static electricity and high volt can damage led, The production whose Die material is Green and blue must strictly required to prevent ESD, Must put on static glove and static fillet, Soldering tool and the cover of device must connect the ground, soldering condition follows the related stating of production specification manual.

## (3) 过电流保护 Protecting countermeasure when over current

为避免由于电压的变化引起大电流冲击而造成产品损坏,需要加入保护电阻。

Need add the protecting resistor in circuit in order to avoid damaging led due to big current and voltage fluctuation.

## (4) LED安装方法 LED installation method

1) 注意各类器件外线的排列以防极性装错,器件不可与发热元件靠得太近,工作条件不要超过其规定的极限。

Pay attention to the led polarity and avoid installation wrong. Led can't be close to euthermic component, work condition should tally with it's specification.

2) 务必不要在引脚间距变形的情况下安装LED。

Don't install the LED under the condition of the led pin deformation.

3) 当装配LED进入PCB或装配孔时,LED支架不能承受任何压力。

The led bracket don't load any pressure when installing the led into PCB or fitting hole.

4) 在焊接温度回到正常以前, 必须避免使LED受到任何的震动或外力。

Must avoid any strike and force on led before the soldering temperature return to room temperature.

## (5) 存储时间Storage time

1) 在温度5°C~35°C, 湿度RH60%条件下, 产品可保存一年。超过保存期的产品需重新检测后方可使用

Led can be stored for a year under the condition: the temperature of 5°C~35°C and humidity of RH60%, These production must be re-inspected and tested before use if their storage time exceed a year.

2) 如果打开的产品在5°C~35°C, RH60%的空气条件下放置超过一周, 则需要将产品在65°C±5°C的环境中放置24小时以上, 并尽量在十五天内使用。

If led is exposed in air for a week under the condition: the temperature of 5°C~35°C, humidity of RH60%, must place the led in the ambience of 65°C±5°C for 24 hours and use it in 15 days for best.

3) 抽真空包装的产品储存超过1-3个月, 重新使用时需烘烤85°C/6H。

The product with vacuum packaging stored over 1-3 months, to be re-used baking 85 °C / 6H.

## (6) 清洗Cleaning

当用化学用品清洗胶体时必须特别小心, 因为有些化学品对胶体表面有损伤并引起褪色如三氯乙烯、丙酮等。可用乙醇擦拭、浸渍, 时间在常温下不超过3分钟。

Be careful of some chemical results in the led colloid fades and damage when using chemical clean the led, such as chloroethylene, acetone etc. can use ethanol to wash or soak led but the time don't exceed 3 minutes.

## 6. 包装PACKAGING

- (1) LEDS 在装带之后纸箱包装. The LEDs are packed in cardboard boxes after taping.
- (2) 装带规格Taping Specifications (单位:毫米Units:mm)

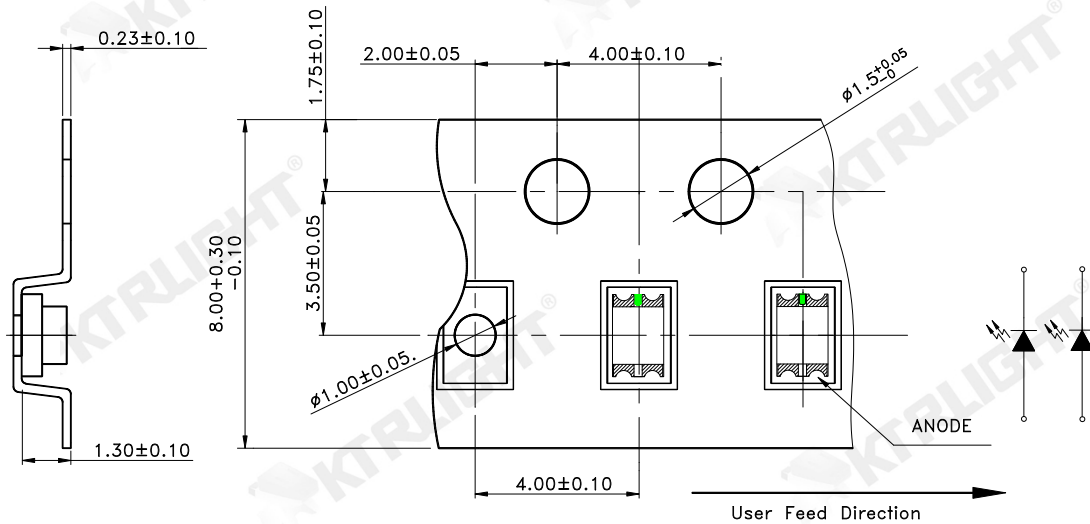

- (3) 卷轴尺寸 Reel Dimension

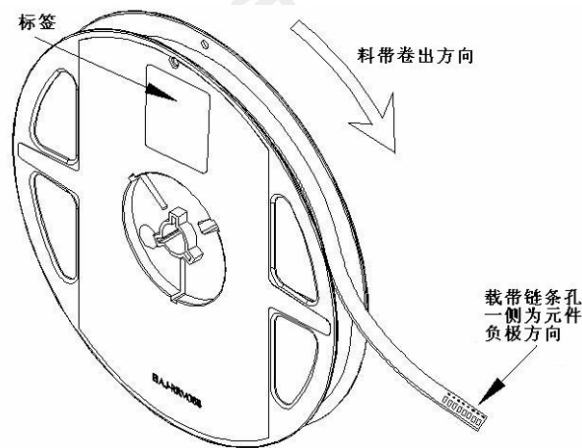

每卷数量3000 个/卷PACKAGE:3000Pcs/Reel

- (4) 最小包装标签注明以下:产品名称.批号.参数范围.数量.

The label on the minimum packing unit shows : Part Number, Lot Number, Ranking, Quantity.

- (5) 请注意防水防潮

Keep away from water, moisture in order to protect the LEDs.

- (6) 须采取适当防护措施,以防包装箱跌落或受到强力撞击造成对产品的损伤.

The LEDS may be damaged if the boxes are dropped or receive a strong impact against them. so precautions must be taken to prevent any damage.