



# 晶体管 TRANSISTOR FHA13009A

## 主要参数 MAIN CHARACTERISTICS

I <sub>C</sub>	12A
V <sub>CB0</sub>	700V
V <sub>CEO</sub>	400V
P <sub>C</sub>	120W

## 用途 APPLICATIONS

电子镇流器	Electronic ballasts
高频开关电源	High frequency switching power supply
高频功率变换	High frequency power transform
一般功率放大电路	Commonly power amplifier circuit

## 产品特性 FEATURES

高耐压	High breakdown voltage
高开关速度	High switching speed
高电流容量	High current capability
高可靠性	High reliability
RoHS 产品	RoHS product

## 封装形式 Package

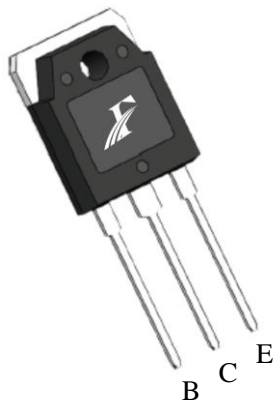

TO-3PN

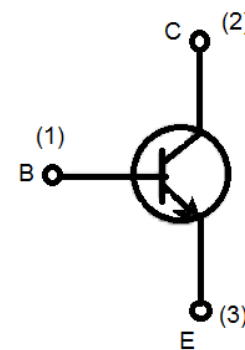

## 绝对最大额定值 ABSOLUTE RATINGS (T<sub>c</sub>=25°C)

项目 Parameter	符号 Symbol	数值 Value	单位 Unit
集电极—基极直流电压 Collector- Base Voltage ( I <sub>E</sub> =0 )	V <sub>CB0</sub>	700	V
集电极—发射极直流电压 Collector- Emitter Voltage ( I <sub>B</sub> =0 )	V <sub>CEO</sub>	400	V
发射极—基极直流电压 Emitter-Base Voltage ( I <sub>C</sub> =0 )	V <sub>EB0</sub>	9	V
最大集电极直流电流 Collector Current ( DC )	I <sub>C</sub>	12	A
最大集电极耗散功率 Total Dissipation ( TO-3PN )	P <sub>C</sub>	120	W
最高结温 Junction Temperature	T <sub>j</sub>	150	°C
贮存温度 Storage Temperature	T <sub>stg</sub>	-55~+150	°C

## 热特性 THERMAL CHARACTERISTIC

项目 Parameter	符号 Symbol	最小值 (min)	最大值 (max)	单位 Unit
结到环境的热阻 Thermal Resistance Junction Ambient	R <sub>th(j-a)</sub>	-	125	°C/W

## 电特性 ELECTRICAL CHARACTERISTICS

项目 Parameter	测试条件 Tests conditions	最小值 (min)	典型值 (typ)	最大值 (max)	单位 Unit
$V(BR)_{CBO}$	$I_C=100\mu A, I_E=0$	700	-	-	V
$V(BR)_{CEO}$	$I_C=10mA, I_B=0$	400	-	-	V
$V(BR)_{EBO}$	$I_E=1mA, I_C=0$	9	-	-	V
$I_{CEO}$	$V_{CE}=400V, I_E=0$	-	-	10	$\mu A$
$I_{EBO}$	$V_{EB}=9V, I_C=0$	-	-	200	nA
$I_{CBO}$	$V_{CB}=700V, I_E=0$	-	-	200	nA
$H_{fe}(1)$	$V_{CE}=5V, I_C=3A$	15	-	35	
$H_{fe}(2)$	$V_{CE}=5V, I_C=5A$	15	-	35	
$H_{fe}(3)$	$V_{CE}=5V, I_C=8A$	8	-	-	
$V_{CE(sat)}$	$I_C=5A, I_B=1A$	-	-	1.0	V
$t_s$	$I_C=0.5A$	2	-	10	$\mu s$
$f_T$	$V_{CE}=10V, I_C=0.5A$	4	-	-	MHz

### 放大倍数 $h_{FE}$ Classifications

Classifications	H1	H2
$h_{FE} (1)$	15-25	25-35

特性曲线  
**Typical Performance Characteristics**

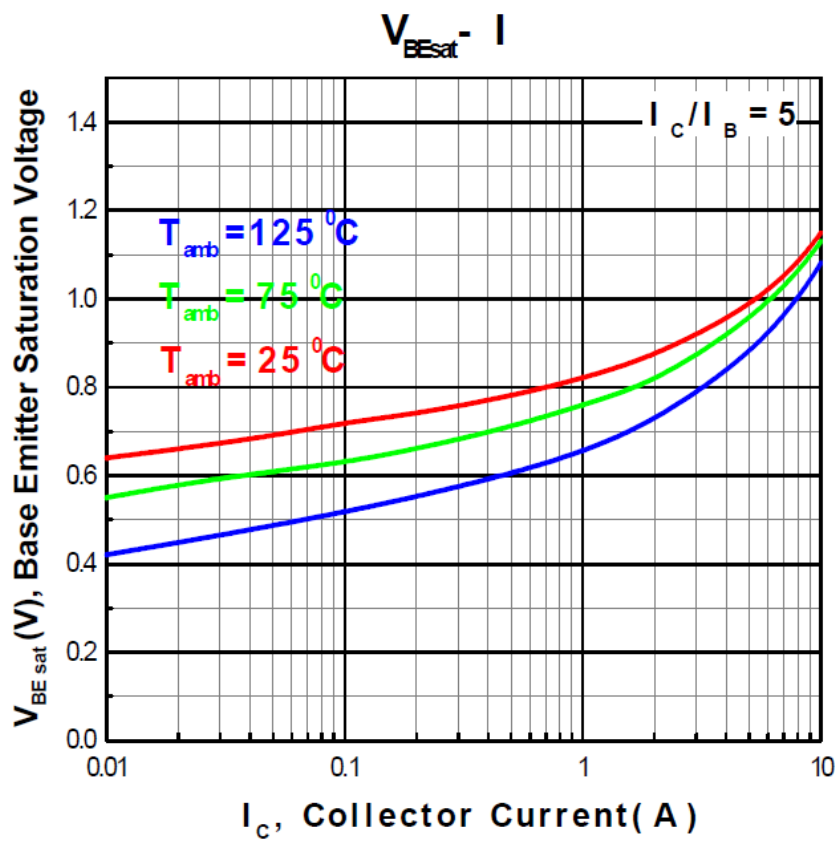
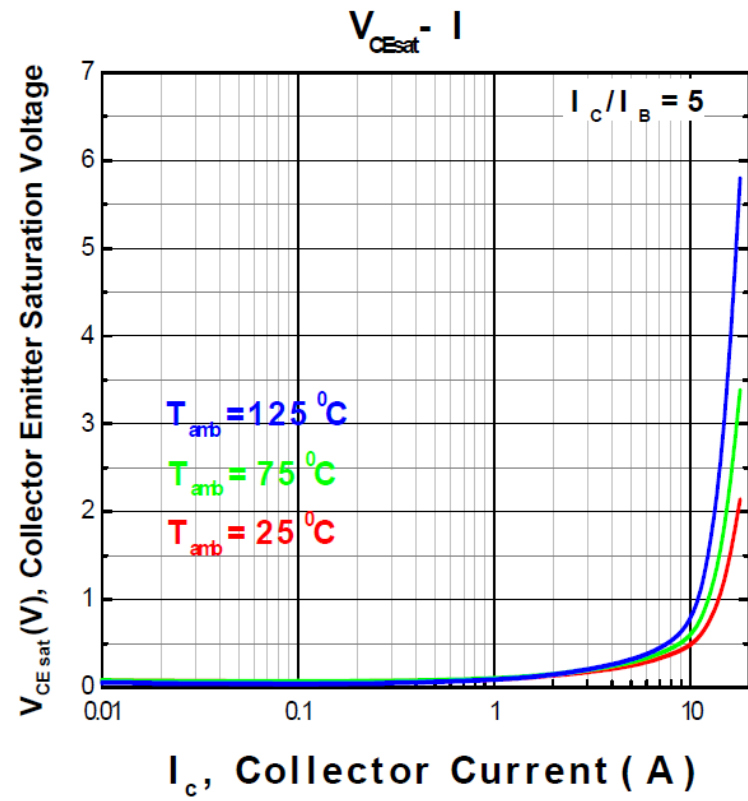
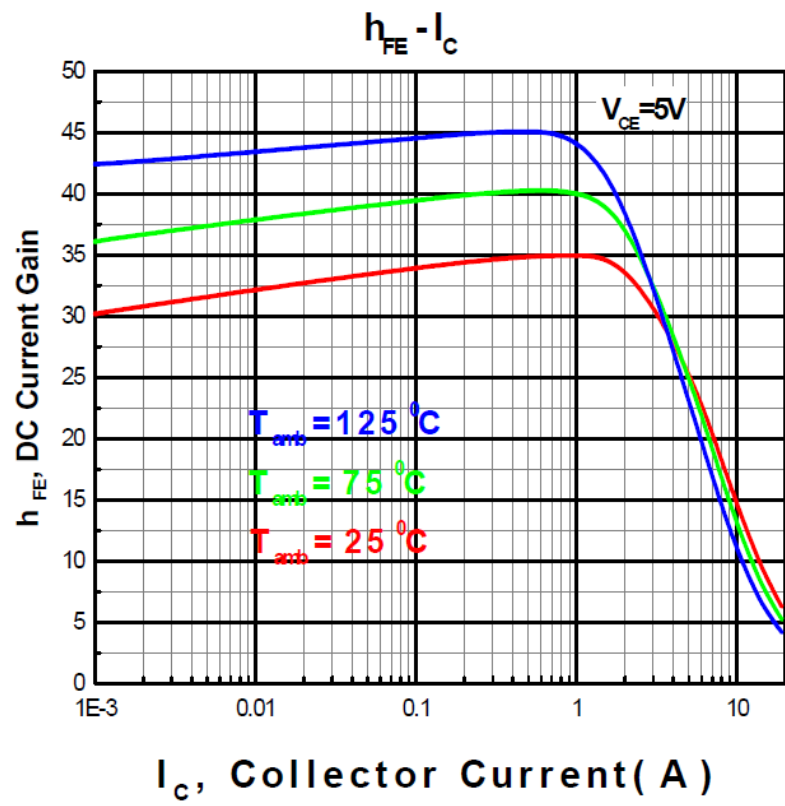

印记 Marking:

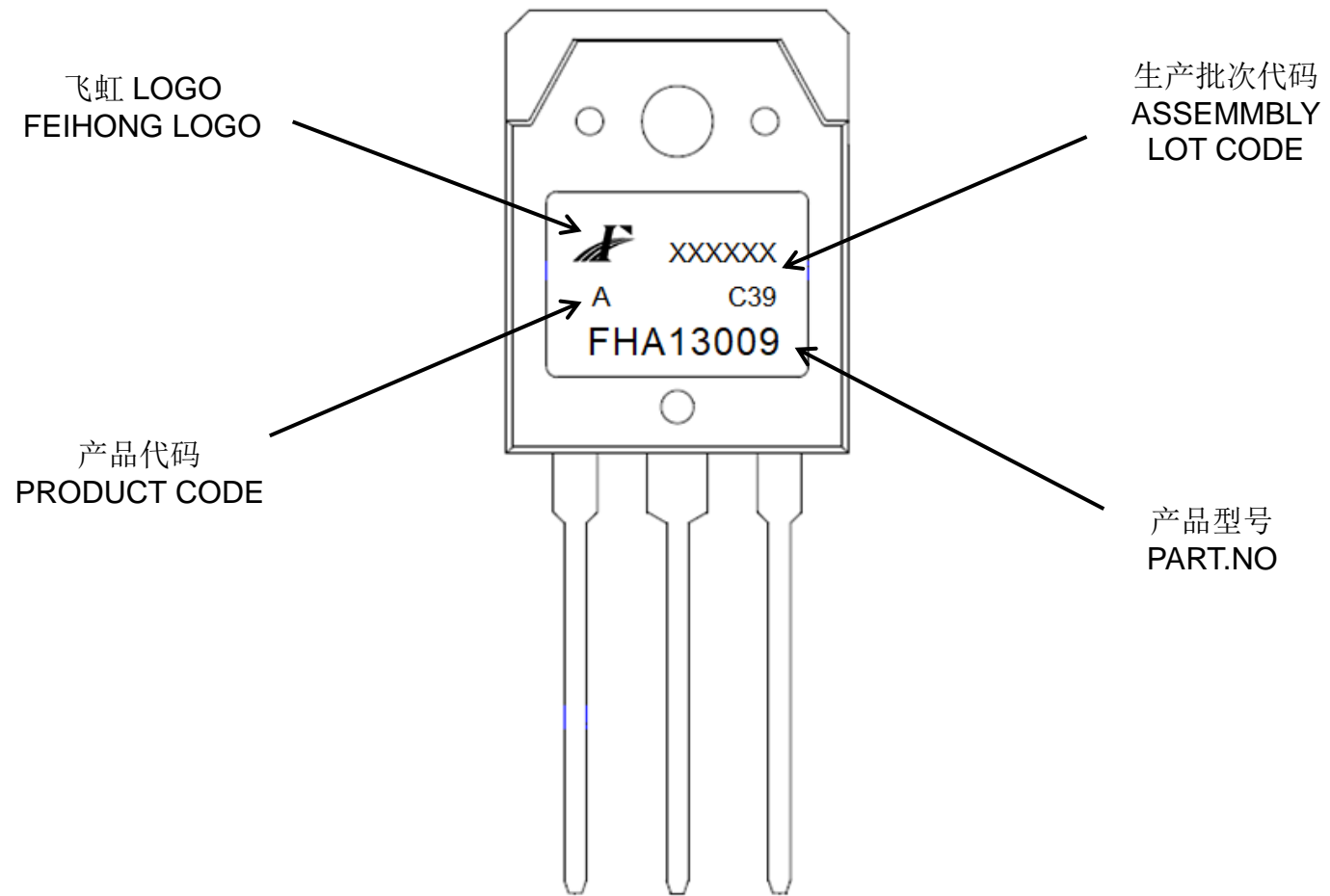

外形尺寸：  
Package Dimension:

TO-3PN

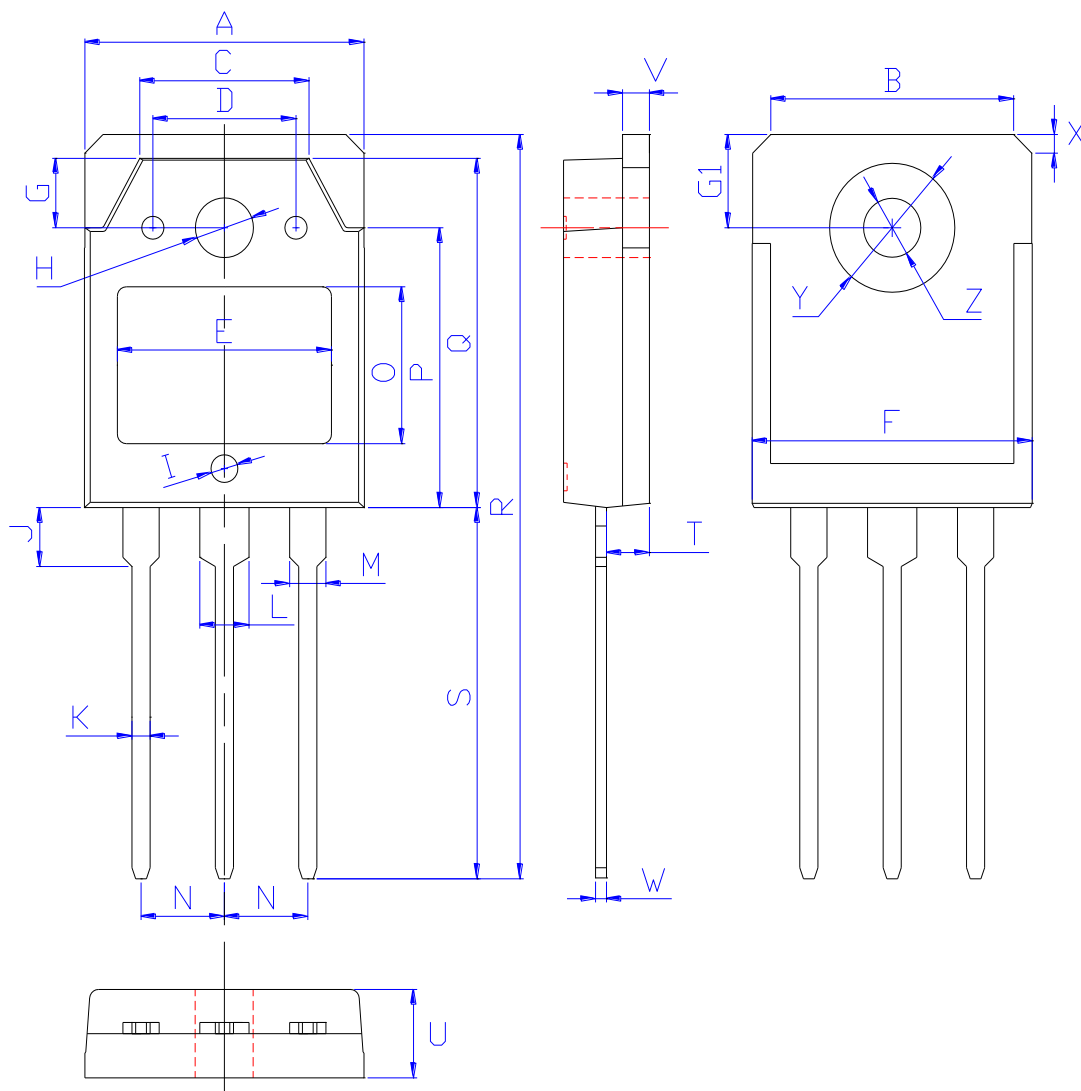

DIM	MILLIMETERS
A	15.60±0.30
B	13.60±0.30
C	9.50±0.30
D	8.00±0.30
E	11.85±0.30
F	15.65±0.30
G	3.80±0.30
G1	5.00±0.30
H	φ 3.50±0.30
I	φ 1.50±0.30 深 0.15±0.15
J	3.20±0.30
K	1.00±0.15
L	3.10±0.15
M	2.10±0.15
N	5.45±0.30
O	8.40±0.30
P	13.90±0.30
Q	18.70±0.30
R	40.00±0.60
S	20.00±0.40
T	2.40±0.30
U	4.80±0.30
V	1.50±0.15
W	0.60±0.15
X	1.80±0.40
Y	7.00±0.30
Z	3.20±0.30

(Units: mm)