

# LMBT2222ATT1G

## S-LMBT2222ATT1G

General Purpose Transistor NPN Silicon

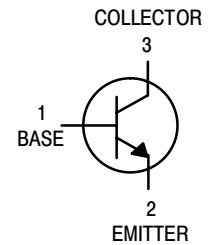
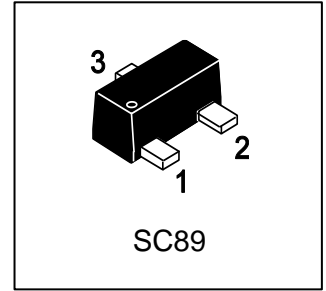

### 1. FEATURES

- We declare that the material of product compliance with RoHS requirements and Halogen Free.
- S- prefix for automotive and other applications requiring unique site and control change requirements; AEC-Q101 qualified and PPAP capable.

### 2. DEVICE MARKING AND RESISTOR VALUES

Device	Marking	Shipping
LMBT2222ATT1G	1P	3000/Tape&Reel
LMBT2222ATT3G	1P	10000/Tape&Reel

### 3. MAXIMUM RATINGS(Ta = 25°C)

Parameter	Symbol	Limits	Unit
Collector–Emitter Voltage	VCEO	40	V
Collector–Base Voltage	VCBO	75	V
Emitter–Base Voltage	VEBO	6	V
Collector Current — Continuous	IC	600	mA

### 4. THERMAL CHARACTERISTICS

Parameter	Symbol	Limits	Unit
Total Device Dissipation, (Note 1) @ TA = 25°C	PD	150	mW
Thermal Resistance, Junction–to–Ambient	RθJA	833	°C/W
Operating and Storage Junction Temperature Range	TJ,Tstg	-55~+150	°C

1. Device mounted on FR4 glass epoxy printed circuit board using the minimum recommended footprint.
2. Pulse Test: Pulse Width  $\leq 300\mu\text{s}$ , Duty Cycle  $\leq 2.0\%$ .

**5. ELECTRICAL CHARACTERISTICS (Ta= 25°C)**
**OFF CHARACTERISTICS**

Characteristic	Symbol	Min.	Typ.	Max.	Unit
Collector–Emitter Breakdown Voltage(Note 1) (IC = 1.0 mA, IB = 0)	V(BR)CEO	40	-	-	V
Collector–Base Breakdown Voltage (IC = 10 μA, IE = 0)	V(BR)CBO	75	-	-	V
Emitter–Base Breakdown Voltage (IE = 10 μA, IC = 0)	V(BR)EBO	6	-	-	V
Base Cutoff Current (VCE = 60 V, VEB = 3.0 V)	IBL	-	-	20	nA
Collector Cutoff Current (VCE = 60 V, VEB = 3.0 V)	ICEX	-	-	100	nA
Collector Cutoff Current (VCB = 60 V, IE = 0)	ICBO	-	-	100	nA
Emitter Cutoff Current (VEB = 3.0 V, IC = 0)	IEBO	-	-	100	nA

**ON CHARACTERISTICS**

DC Current Gain (IC = 0.1 mA, VCE = 10 V) (IC = 1.0 mA, VCE = 10 V) (IC = 10 mA, VCE = 10 V) (IC = 150 mA, VCE = 10 V) (IC = 500 mA, VCE = 10 V)	HFE	35 50 75 100 40	- - - - -	- - - - -	
Collector–Emitter Saturation Voltage (IC = 150 mA, IB = 15 mA) (IC = 500 mA, IB = 50 mA)	VCE(sat)	- -	- -	0.3 1	V
Base–Emitter Saturation Voltage (IC = 150 mA, IB = 15 mA) (IC = 500 mA, IB = 50 mA)	VBE(sat)	0.6 -	- -	1.2 2	V

**SMALL-SIGNAL CHARACTERISTICS**

Current–Gain – Bandwidth Product (IC = 20 mA, VCE = 20 V, f = 100 MHz)	fT	250	-	-	MHz
Output Capacitance (VCB = 10 V, IE = 0, f = 1.0 MHz)	Cobo	-	-	8	pF
Input Capacitance (VEB = 0.5 V, IC = 0, f = 1.0 MHz)	Cibo	-	-	30	pF
Input Impedance (VCE = 10 V, IC = 10 mA, f = 1.0 kHz)	hie	0.25	-	1.25	kΩ
Voltage Feedback Ratio (VCE = 10 V, IC = 10 mA, f = 1.0 kHz)	hre	-	-	4	X10 <sup>-4</sup>
Small–Signal Current Gain (VCE = 10 V, IC = 10 mA, f = 1.0 kHz)	hfe	75	-	375	-
Output Admittance (VCE = 10 V, IC = 10 mA, f = 1.0 kHz)	hoe	25	-	200	μmhos
Noise Figure (VCE=10 V, IC=100μA, RS=1kΩ, f = 1 kHz)	NF	-	-	4	dB

**5. ELECTRICAL CHARACTERISTICS (Ta= 25°C)**

## SWITCHING CHARACTERISTICS

Delay Time	(VCC=3.0 V, VBE=-0.5 V, IC=150 mA, IB1=15 mA)	td	-	-	10	ns
Rise Time		tr	-	-	25	
Storage Time	(VCC=30 V, IC=150mA, IB1=IB2=15mA)	ts	-	-	225	
Fall Time		tf	-	-	60	

**6.ELECTRICAL CHARACTERISTICS CURVES**

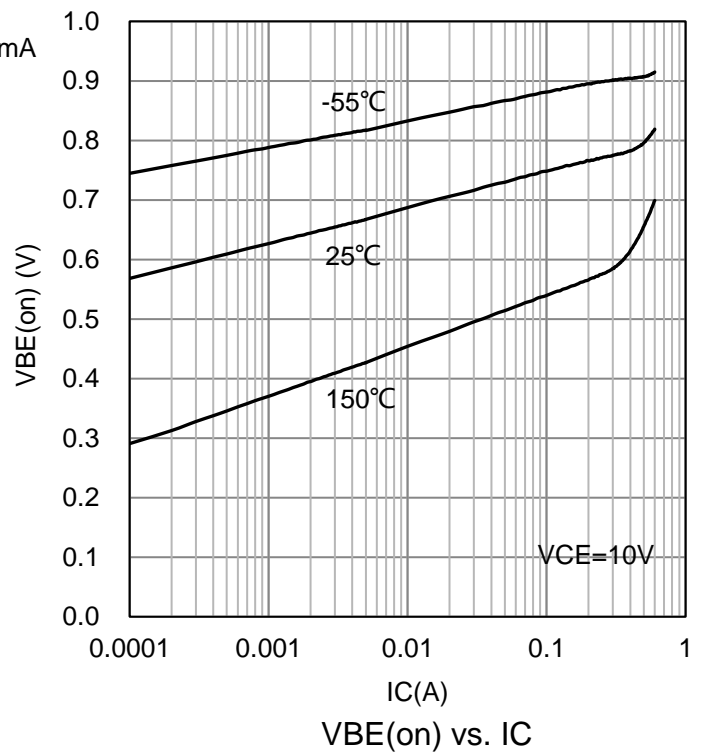
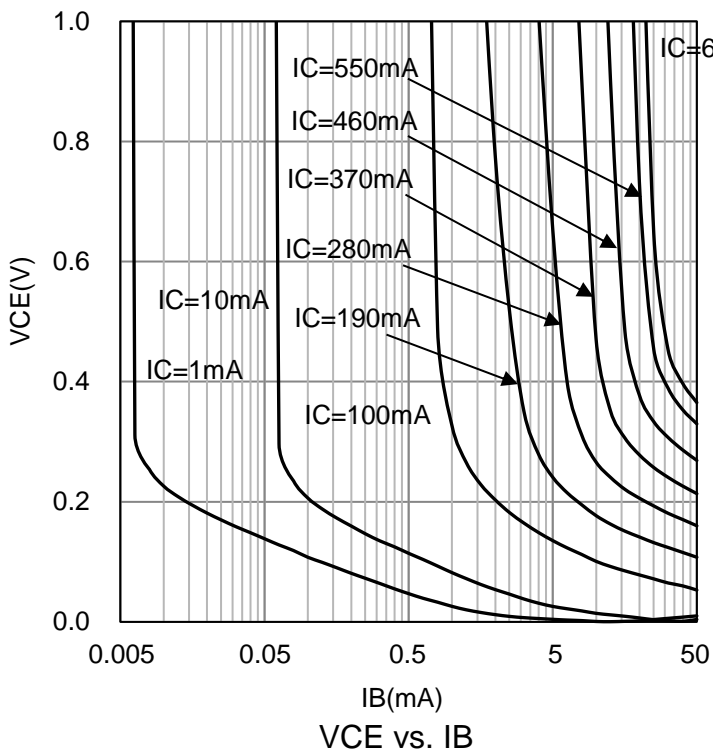
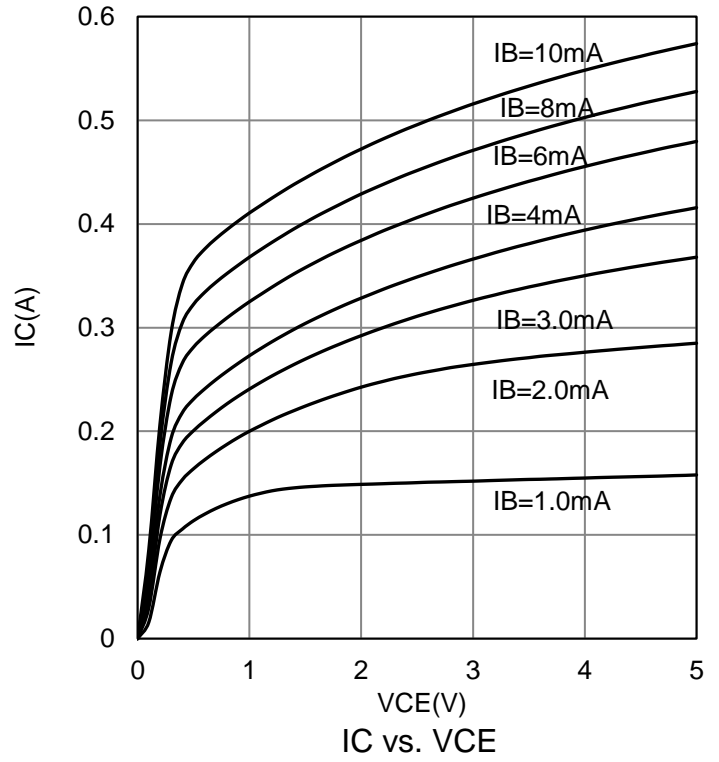
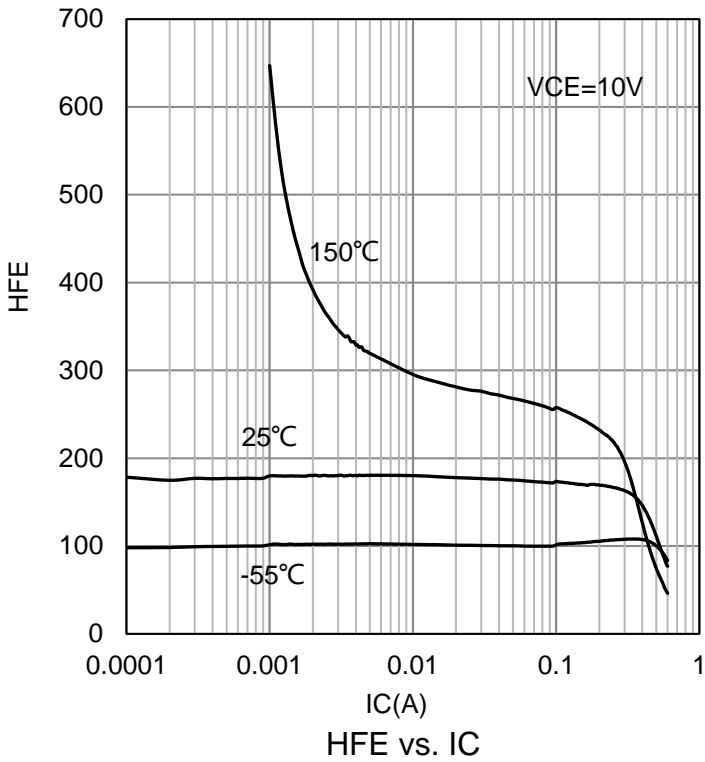

**6.ELECTRICAL CHARACTERISTICS CURVES(Con.)**

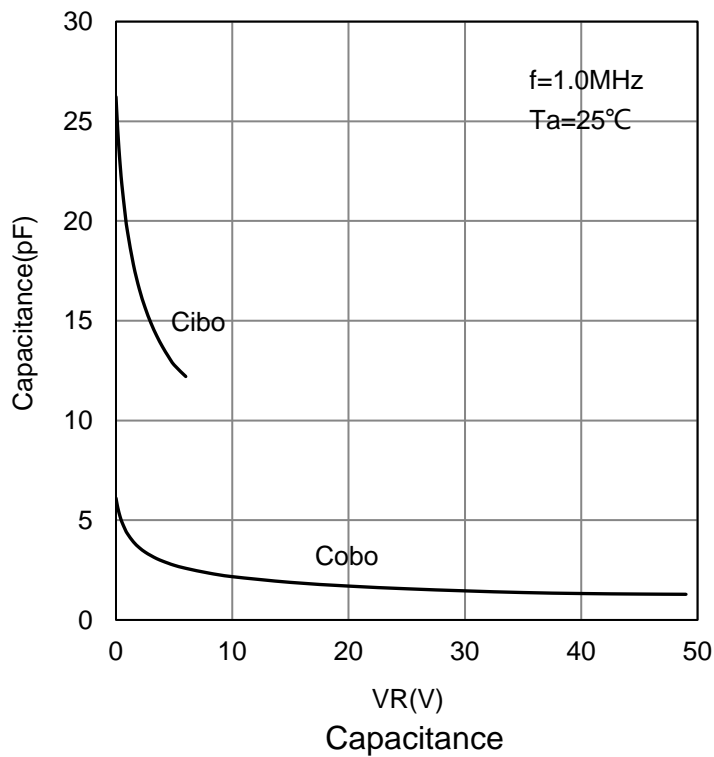
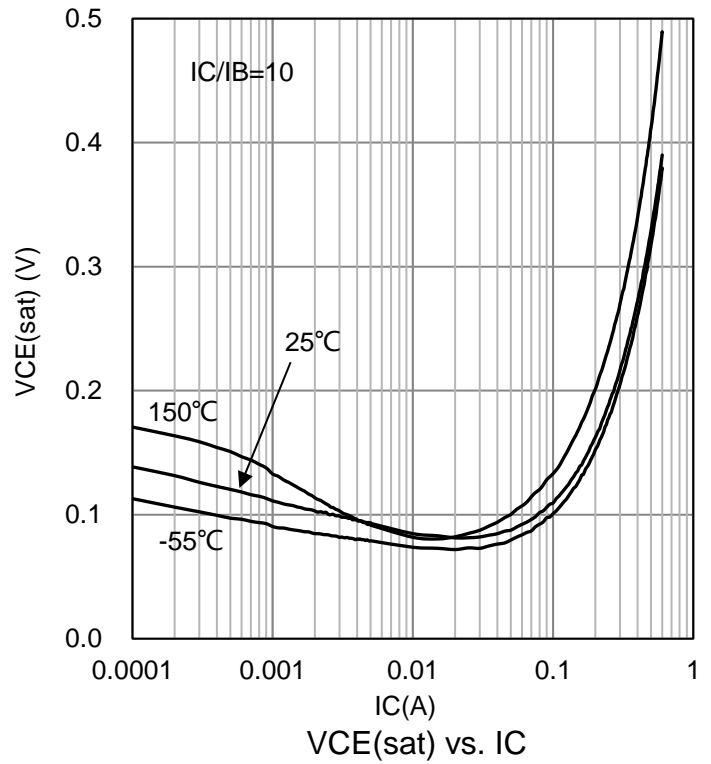
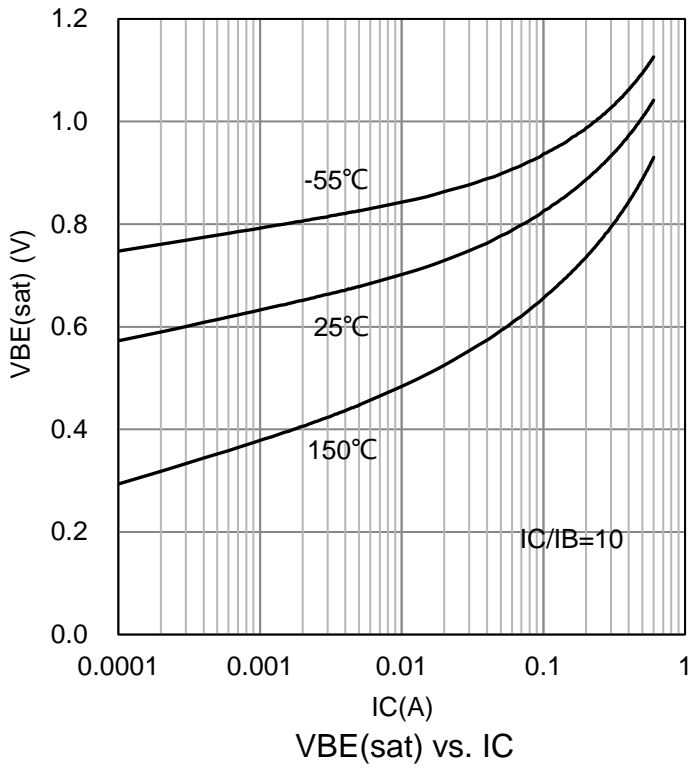

### 7. OUTLINE AND DIMENSIONS

Notes:

1. DIMENSIONING AND TOLERANCING PER ANSI Y14.5M, 1982.
2. CONTROLLING DIMENSION: MILLIMETERS.
3. MAXIMUM LEAD THICKNESS INCLUDES LEAD FINISH. MINIMUM LEAD THICKNESS IS THE MINIMUM THICKNESS OF BASE MATERIAL.
4. DIMENSIONS A AND B DO NOT INCLUDE MOLD FLASH, PROTRUSIONS OR GATE BURRS.

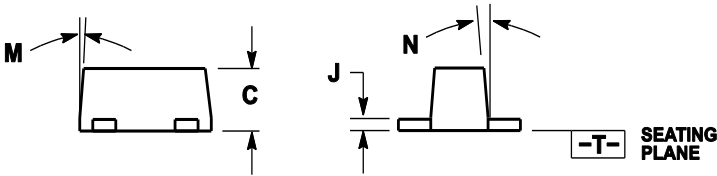
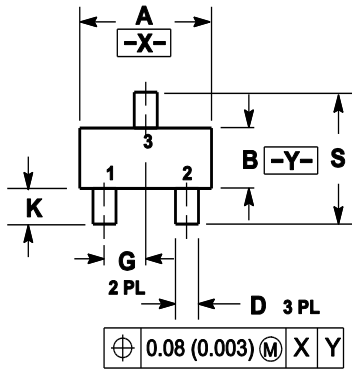

DIM	MILLIMETERS			INCHES		
	MIN	NOM	MAX	MIN	NOM	MAX
A	1.50	1.60	1.70	0.059	0.063	0.067
B	0.75	0.85	0.95	0.030	0.034	0.040
C	0.60	0.70	0.80	0.024	0.028	0.031
D	0.23	0.28	0.33	0.009	0.011	0.013
G	0.50BSC			0.020BSC		
H	0.53REF			0.021REF		
J	0.10	0.15	0.20	0.004	0.006	0.008
K	0.30	0.40	0.50	0.012	0.016	0.02
L	1.10REF			0.043REF		
M	---	---	10°	---	---	10°
N	---	---	10°	---	---	10°
S	1.50	1.60	1.70	0.059	0.063	0.067

### 8. SOLDERING FOOTPRINT

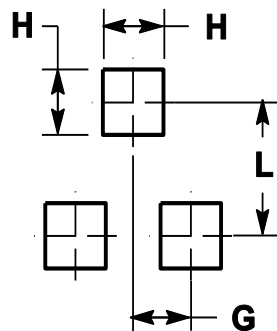

## **DISCLAIMER**

- Before you use our Products, you are requested to carefully read this document and fully understand its contents. LRC shall not be in any way responsible or liable for failure, malfunction or accident arising from the use of any LRC's Products against warning, caution or note contained in this document.
- All information contained in this document is current as of the issuing date and subject to change without any prior notice. Before purchasing or using LRC's Products, please confirm the latest information with a LRC sales representative.